

DENTAL INSTRUMENTS

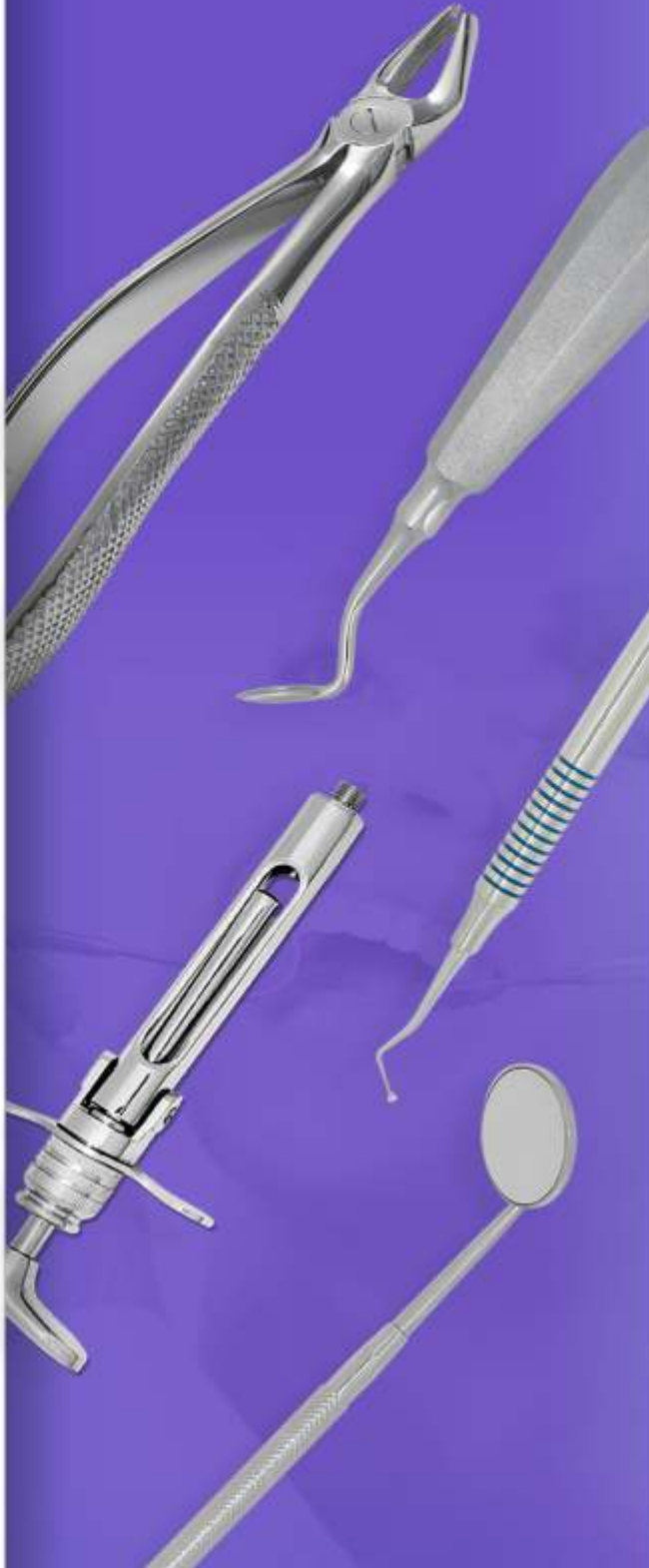

FAIZAN & MUSA
SURGICAL INSTRUMENTS



OEM

ORIGINAL | EQUIPMENTS | MANUFACTURER

ODM

ORIGINAL | DESIGN | MANUFACTURER



About us



Who we are:

The business in which surgical equipments was manufacturing started from our late grandfather Mr. Bashir Khan Sherwani in 1951. He was very hardworking person. With the passage of time, he handed over this entire business to his late son Muhammad Jameel Khan Sherwani.

Our Vision:

Stilt at a young age but with a considerable knowledge of all types of instruments, he developed a VISION "for better establishment of the business by intrinsically motivating work with our employees and fulfill the desired requirements of our customers in coming days till end." Days and nights of toil, hard work and innovation led him to his first development;

Standing Position:

The Scalpel Handle little was known to him and created various instruments including Scissors, Forceps and Tweezers. With advent of time, the surgical industry spread out around and he commenced his company by Kingship int. It was introduced with new skilled personals in this field. Now, his hard work paid off; he got proposal of "laryngoscope" in blunder. Time went by and the Sherwani's family ventured in this business and flourished around with 100% great quality instruments at hospitals, clinics and importers as a family business.

Mission

Later, Muhammad Aouf Khan Sherwani the son of Muhammad Jameel Khan Sherwani joined and served the business with his excellent expertise and immense knowledge related instruments became a resource for expanding the business. His great father's MISSION "was to well established this more with more possible ways.

Pakindo Alat Medis

Ultimately, in the year 1989 Kingship int turn to Pakindo Alat Medis around the surgical industry. Above was the simple and inspired beginning of Pakindo Alat Medis established with a single minded with;

Our Aim,

Goal & objective "Providing high quality instruments for life-saving and precision tools for better patient care entire the world same as happy family."

Our Values:

Our core values are our clients life happiness, our revenue will be client's satisfaction with smiles, we are influencing our employee's opinion and facilitate them entire their lives.



50



Extracting Forceps,American Pattern
Zahnzangen,Amerikanische Form
Daviers,Forme americaine
Forceps de extrozione,forma americana

page 001 to 016

51



Extracting Forceps,English Pattern
Zahnzangen,Englische Form
Daviers,Forme anglaise
Forceps dentales,forma inglesa
Pinze per estrazione,forma inglese

page 017 to 043

52



Root Elevators
Wurzelheber
Elevateurs a racines
Botadores para raices
Leve per radici

page 042 to 057

53



Bone Files
Bone-Dateien
Archivos de huesos
Fichiers d'os
Bone Files

page 058 to 060

54

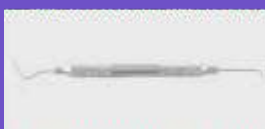

Dental Probes
Zahnsonden
Sondes Dentales
Sondes Dentaires
Sonde Dentali

page 061 to 061

55



Enamel Instruments
Emaile-Instrumente
Instrumentos de esmalte
Instruments d'email
Strumenti per smalto

page 064 to 068

56



Dental Scalers
Zahnsteinentferner
Escaladores dentales
Scalers dentaires
Scaler dentali

page 069 to 087

57



Bone Curettes
Knochenkuretten
Curetas de hueso
Curettes osseuses
Curettes d'ossa

page 086 to 092

58



Excavators
Bagger
Excavadoras
Pelles
Escavatori

page 093 to 098

59



Wax Proclein
Wachs-Porzellan
Cera Porcelana
Cire Porcelaine
Cera Porcellana

page 099 to 104

60



Filling Instruments
Fullungsinstrumente
Actos de llenado
Instruments de remplissage
Strumenti di riempimento

page 105 to 116

61



Gingivectomy Knives
Gingivektomie Messer
Cuchillos de gingivectomia
Couteaux de gingivectomie
Coltelli per gengivectomia

page 117 to 119

62



Cement Spatulas
Zementspatel
Espatulas de cemento
Spatules de ciment
Spatole di cemento

page 120 to 125

63

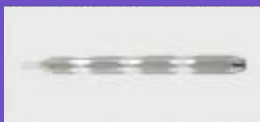

Mouth Mirrors
Mundspiegel
Espejos Bucales
Bouche Miroirs
Bocca specchi

page 126 to 129

64



Amalgam Instruments
Amalgam Instrumente
Instrumentos de amalgama
Instruments Amalgam
Strumenti amalgama

page 130 to 132

65



Matrix Retainers
Matrix-Halterungen
Retenedores de matrices
Retenue de matrice
Matrix Retainers

page 133 to 141

66



Hemostatic Forceps
Arterienklemmen
Pincas Hemostaticas
Pinzashemostaticas
Pinze Emostatiche

page 142 to 149

67



Towel Clamps
Handtuchklammern
Abrazaderas de toalla
Pincas a serviettes
Morsetti per asciugamano

page 150 to 152

68



Needle Holders
Nadelhalter
Porte-aiguilles
Porta-agujcs
port'aghi

page 153 to 162

69



Retractors
Wundhaken
Ecarteurs
Separadores
Divaricatori

page 163 to 168

70



Mouth and Tongue
Mund und Zunge
Boca y la lengua
Bouche et langue
Bocca e la lingua

page 126 to 129

71



Scissors
Schiere
Tijeras
Les Ciseaux
Forbici

page 174 to 193

72



Micro Scissors
Mikroschiere
Micro tijeras
Micro-ciseaux
Micro forbici

page 194 to 196

73



Orthodontics
Kieferorthopadie
Ortodoncia
Orthodontie
Ortodonzia

page 197 to 214

74



Bone Rongeurs
Knochen Rongeur
Rongeurs de hueso
Os Rongeurs
Bone Rongeurs

page 215 to 218

75



Forceps
Zange
Forceps
Forcipes
Forcipe

page 219 to 227

76



Scalpel Handles
Skalpelli
Manches de bistouris
Mangos de Bisturios
Manici per bisturi

page 228 to 230

77



Mallets
Schlagel
Mazos
Maillets
Mallets

page 231 to 234

78



Cassettes
Kassetten
Cassettes
Cassettes
Cassette

page 235 to 239

79



Cylinder cartidge syringe
Zylinder-Ampullenspritze
Seringue a ampoule cylindrique
Jeringo para cartucho ampollas
Siringe ampollare a cilindro

page 240 to 246

80



Impression Trays
Abdruckloffel
Porte empreintes
Cubetas para impresiones
Portaimpronte

page 247 to 259

81



Articulators
Artikulatoren
Articuladores
Articulateurs
Articolatori

page 260 to 270

82



Holloware
Holloware
Holloware
Platerie
Holloware

- EN** Extracting Forceps, American Pattern
- DE** Zahnzangen, Amerikanische Form
- ES** Daviers, forme américaine
- FR** Forceps de extraction, forma americana
- IT** Pinze per estrozione, forma americana

Page 01 to 15

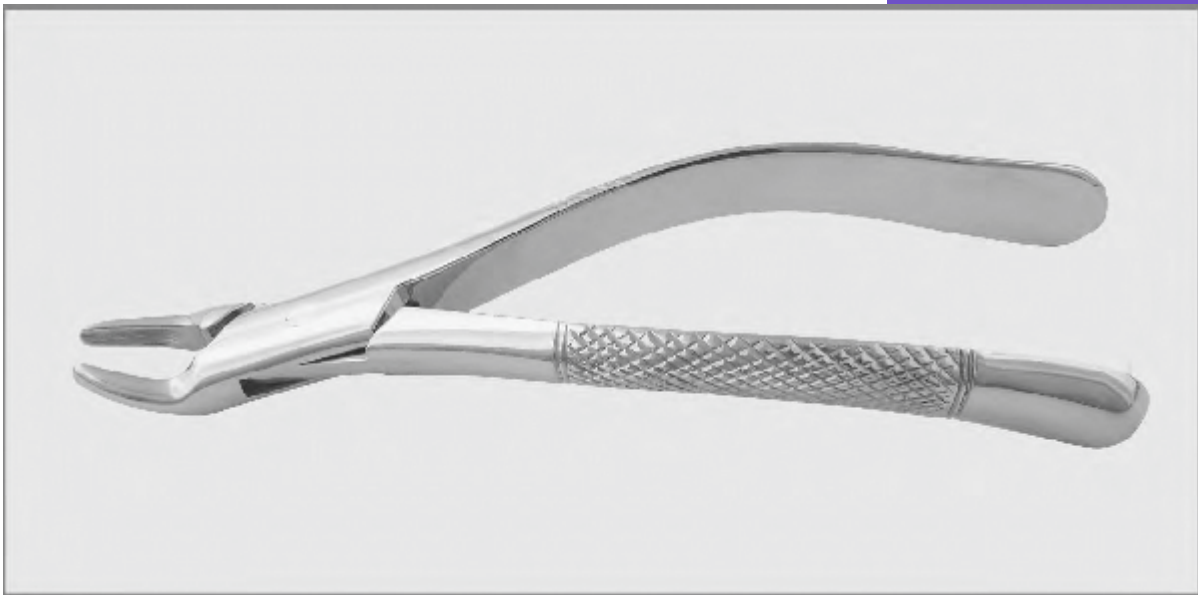

EN Extracting Forceps American Pattern
 DE Extraktionszange amerikanisches Muster
 ES Extraer el patrón estadounidense de fórceps
 FR Forceps d'extraction modèle américain
 IT Estrazione del forcipe modello americano



EXTRACTION



Fig. 1



FM- 0,50-1001



FM- 0,50-1002

HENAHAN
Fig. 1 A



FM- 0,50-1003



Fig. 1 B



JMLWAUKEE
Fig. 3



FM- 0,50-1004



WOOD-WARD
Fig. 3 FH



FM- 0,50-1005



FM- 0,50-1006

WOOD-WARD
Fig. 3 FS



FM- 0,50-1007

PHYSICK
Fig. 5



FM- 0,50-1008

Fig. 6

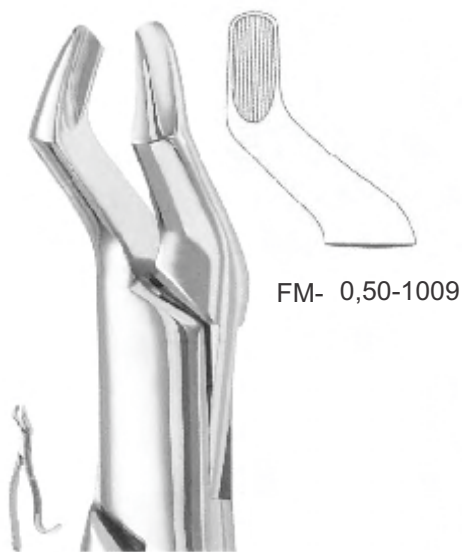

FM- 0,50-1009

Fig . 10 H

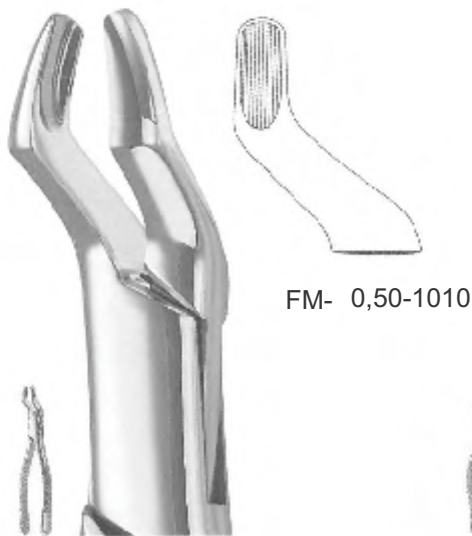

FM- 0,50-1010

Fig . 10 S



FM- 0,50-1011

HARRIS
Fig . 15



FM- 0,50-1012

HARRIS
Fig. 16



FM- 0,50-1013

Fig. 16 S

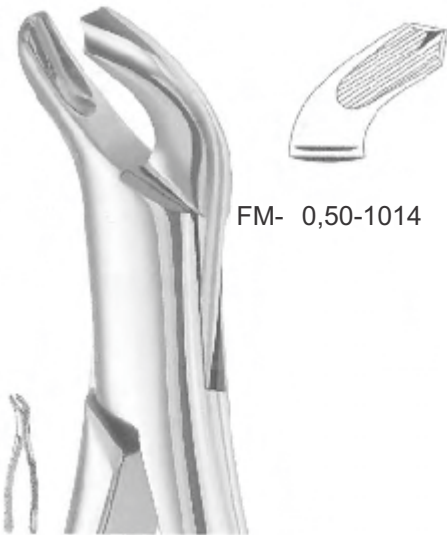

FM- 0,50-1014

Fig. 17

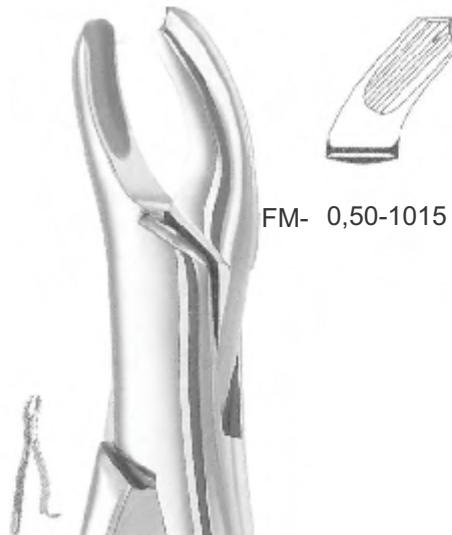

FM- 0,50-1015

HARRIS
Fig. 18 L

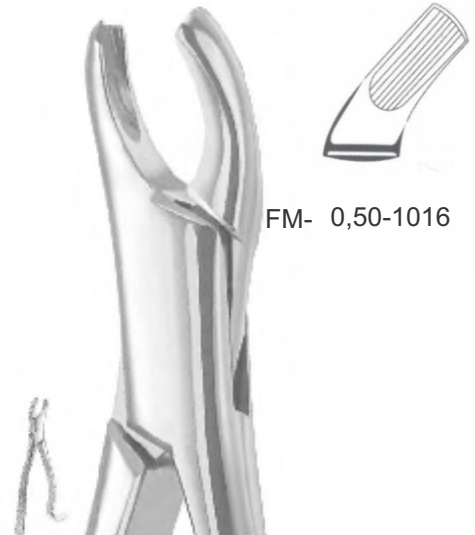

FM- 0,50-1016

HARRIS
Fig. 18 R

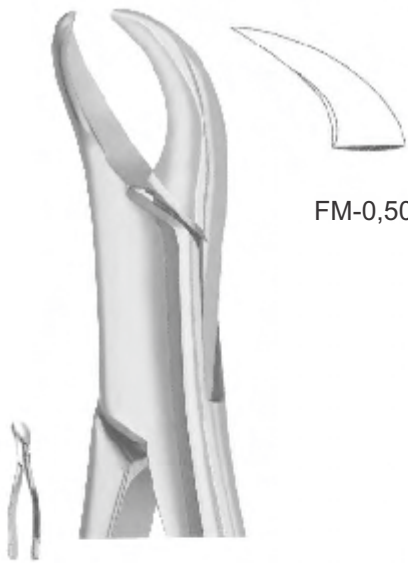

FM-0,50-1017

Fig. 23

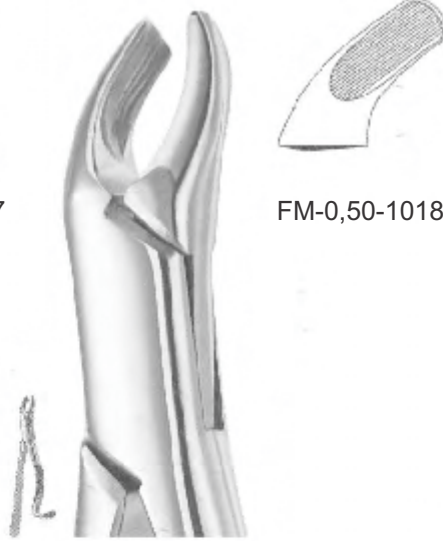

FM-0,50-1018

Fig. 24

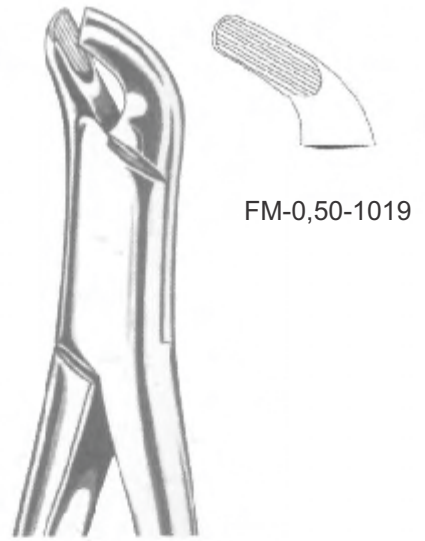

FM-0,50-1019

Fig. 27



FM-0,50-1020

PARMLY
Fig. 32



FM-0,50-1021

PARMLY
Fig. 32 A

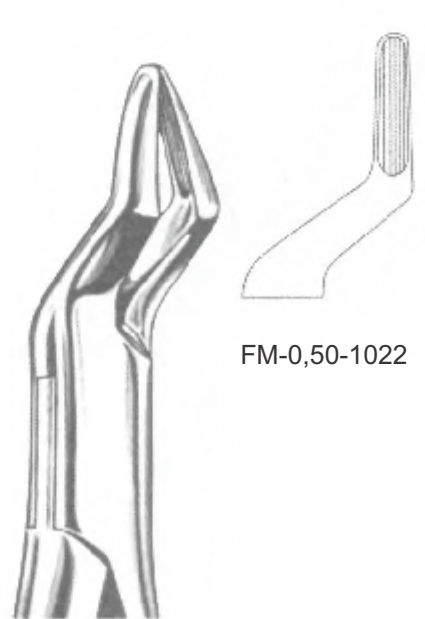

FM-0,50-1022

Fig. 35

EN Extracting Forceps American Pattern
DE Extraktionszange amerikanisches Muster
ES Extraer el patrón estadounidense de fórceps
FR Forceps d'extraction modèle américain
IT Estrazione del forcipe modello americano



FM-0,50-1023

Fig. 53 L



FM-0,50-1024

Fig. 53 R

Extracting Forceps American Pattern	EN
Extraktionszange amerikanisches Muster	DE
Extraer el patrón estadounidense de fórceps	ES
Forceps d'extraction modèle américain	FR
Estrazione del forcipe modello americano	IT



Fig. 62



FM-0,50-1025



Fig. 65



FM-0,50-1026



TOMES
Fig. 69



FM-0,50-1027



THOMAS
Fig. 85



FM-0,50-1028



THOMAS
Fig. 85 A



FM-0,50-1029

EXTRACTION

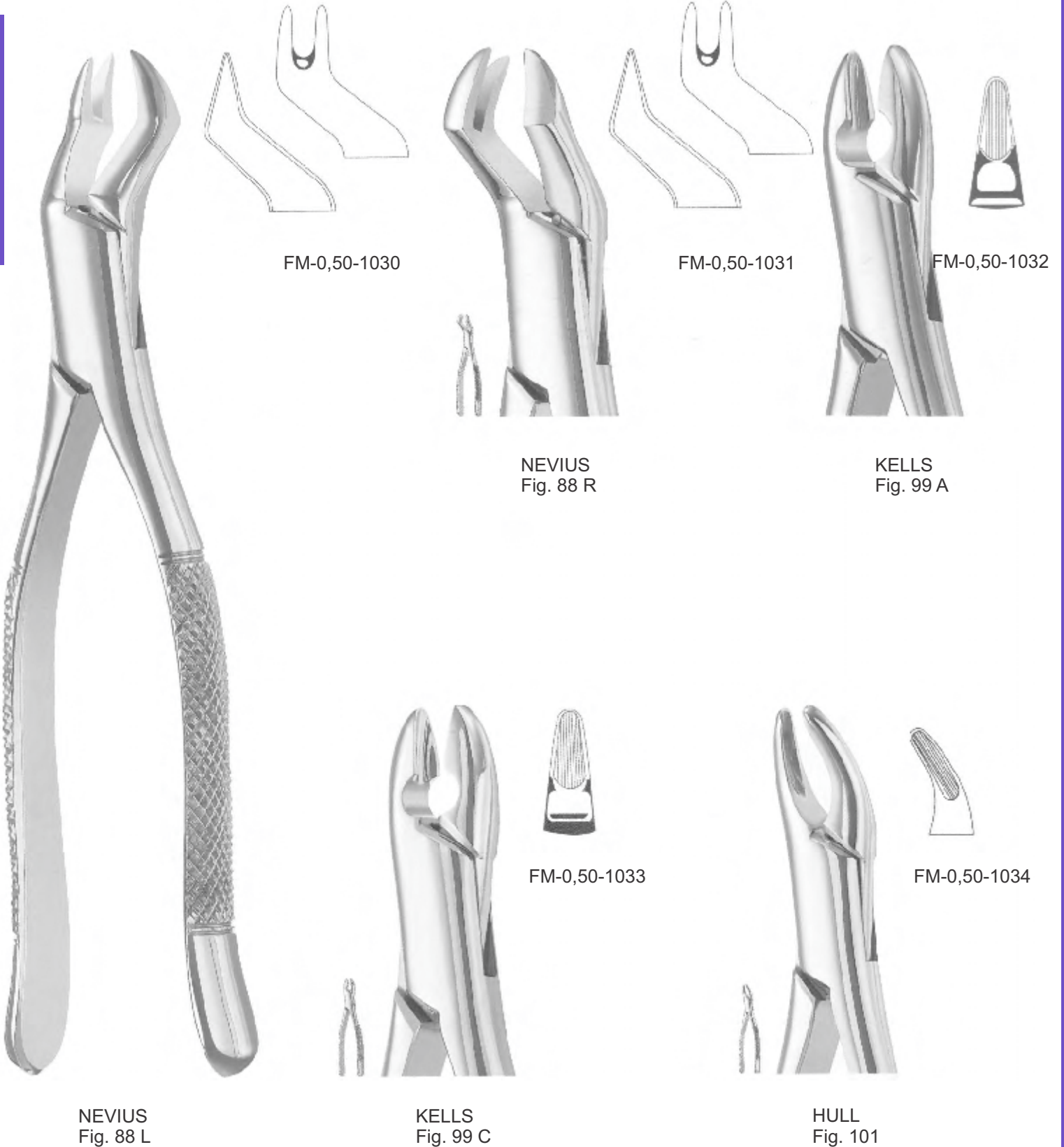



Fig. 103



FM-0,50-1035



Fig. 10 H



FM-0,50-1036



Fig. 10 S



FM-0,50-1037



CRYER
Fig. 150



FM-0,50-1038



CRYER
Fig. 150 A



FM-0,50-1039

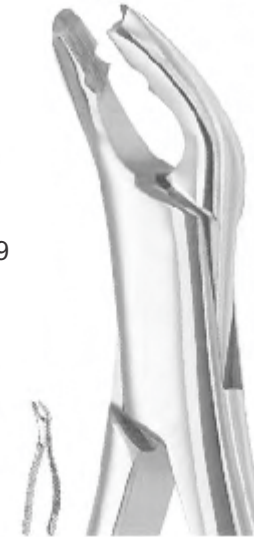

Fig. 150 X



FM-0,50-1040

EN Extracting Forceps American Pattern
 DE Extraktionszange amerikanisches Muster
 ES Extraer el patrón estadounidense de fórceps
 FR Forceps d'extraction modèle américain
 IT Estrazione del forcipe modello americano



FM-0,50-1041



FM-0,50-1042



FM-0,50-1043

Fig. 150 AB

Fig. 150 AS

CRYER
Fig. 150 S

Extracting Forceps American Pattern	EN
Extraktionszange amerikanisches Muster	DE
Extraer el patrón estadounidense de fórceps	ES
Forceps d'extraction modèle américain	FR
Forceps d'extraction modèle américain	IT



CRYER
Fig. 151



CRYER
Fig. 151 A



Fig. 151 X

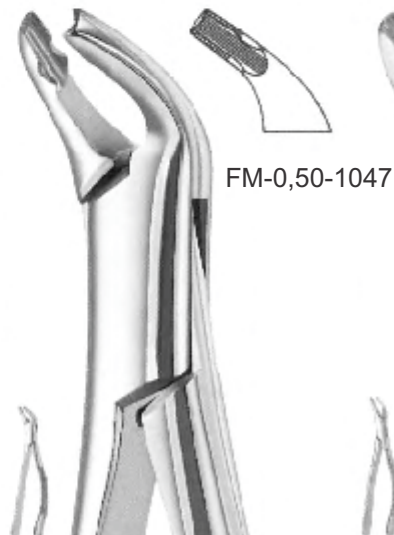
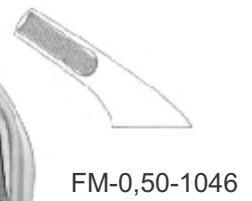

CRYER
Fig. 151 AB

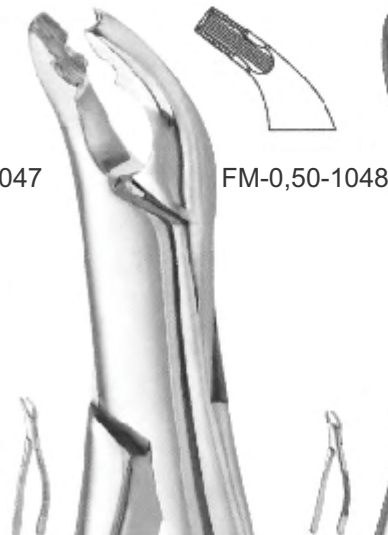

Fig. 151 AS



CRYER
Fig. 151 S





Fig.201



Fig.203

FM-0,50-1051



Fig.217

FM-0,50-1052



Fig.210 H



Fig.210 S

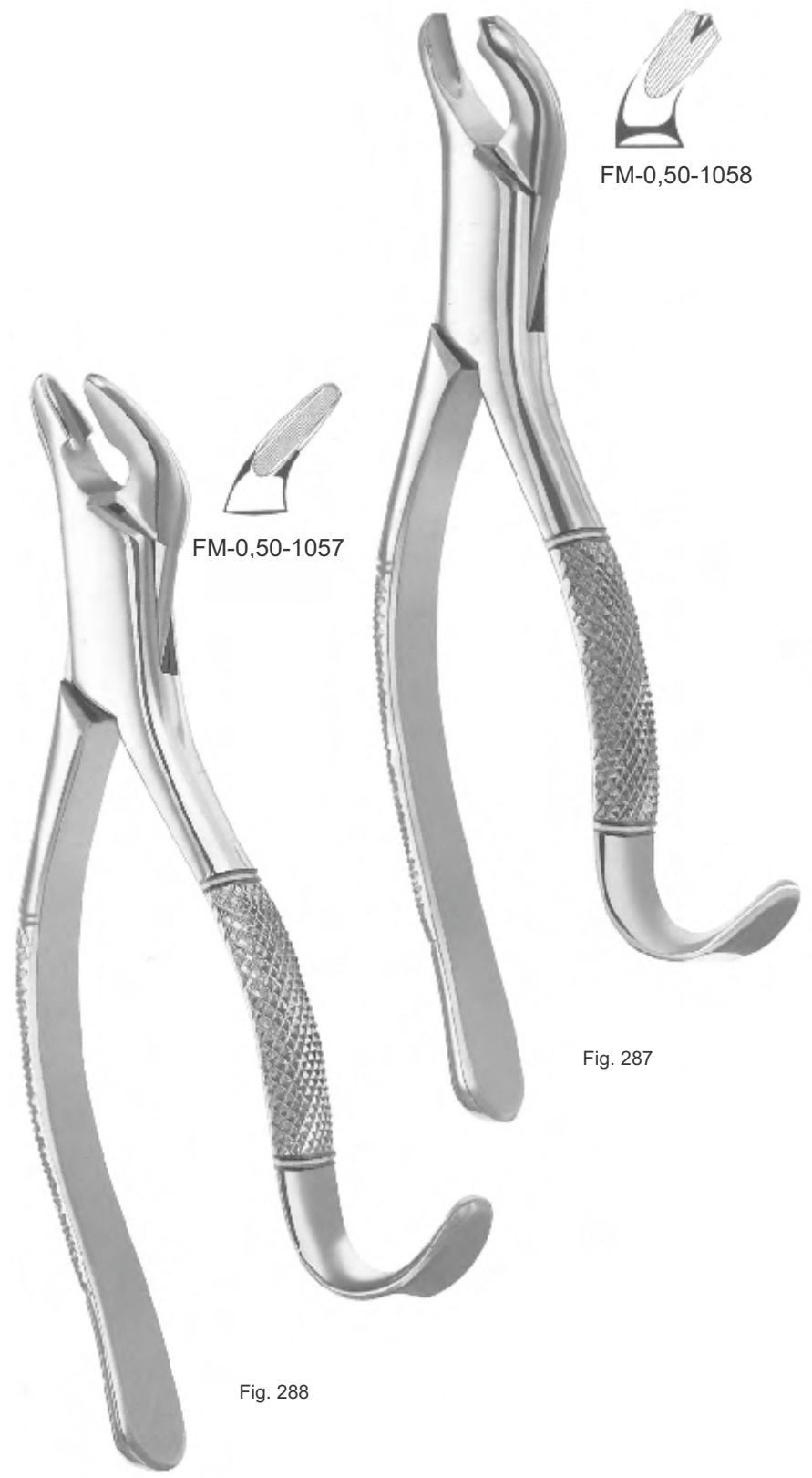

Fig.222



Extracting Forceps American Pattern **EN**
 Extraktionszange amerikanisches Muster **DE**
 Extraer el patrón estadounidense de fórceps **ES**
 Forceps d'extraction modèle américain **FR**
 Estrazione del forcipe modello americano **IT**

50



EXTRACTION

EN Extracting Forceps American Pattern
 DE Extraktionszange amerikanisches Muster
 ES Extraer el patrón estadounidense de fórceps
 FR Forceps d'extraction modèle américain
 IT Estrazione del forcipe modello americano



Extracting Forceps American Pattern **EN**
Extraktionszange amerikanisches Muster **DE**
Extraer el patrón estadounidense de fórceps **ES**
Forceps d'extraction modèle américain **FR**
Estrazione del forcipe modello americano **IT**

50

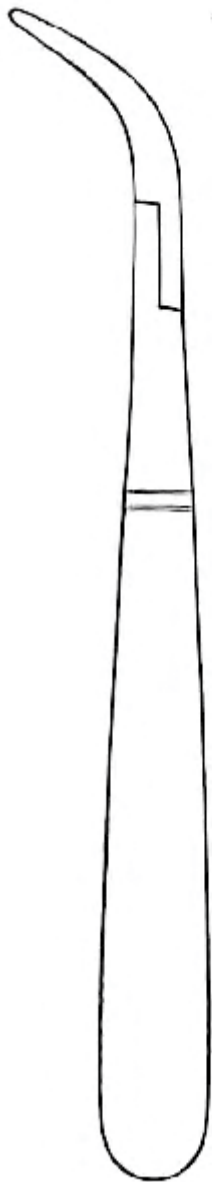

FM-0,50-1061
WITZEL
Fig.501

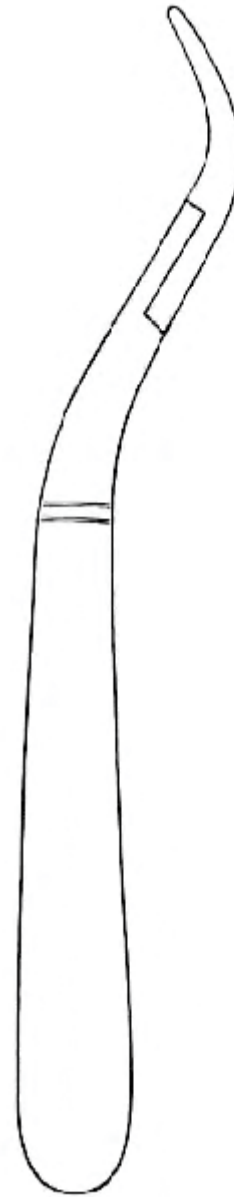

FM-0,50-1062
WITZEL
Fig.502

EXTRACTION

EN Extracting Forceps American Pattern
 DE Extraktionszange amerikanisches Muster
 ES Extraer el patrón estadounidense de fórceps
 FR Forceps d'extraction modèle américain
 IT Estrazione del forcipe modello americano



FM-0,50-1063

Fig. 17 SK



FM-0,50-1064

Fig. 23 SK



FM-0,50-1065

Fig. 150 Sk



FM-0,50-1066

Fig. 151 Sk

EN	Extracting forceps, English pattern
DE	Zahnzangen, Englische Form
ES	Daviers, forme anglaise
FR	Fórceps dentales, forma inglesa
IT	Pinze per estrazione, forma inglese

Page 16 - 38



EN	Extracting Forceps English Pattern
DE	Zange extrahieren englisches Muster
ES	Extracto de fórceps patrón inglés
FR	Forceps d'extraction modèle anglais
IT	Estrazione del forcipe modello inglese



Fig. 1

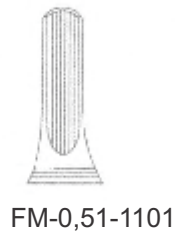

Fig. 2

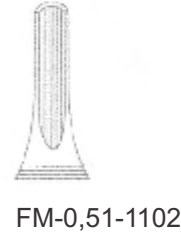

Fig. 3



Fig. 4



Fig. 7



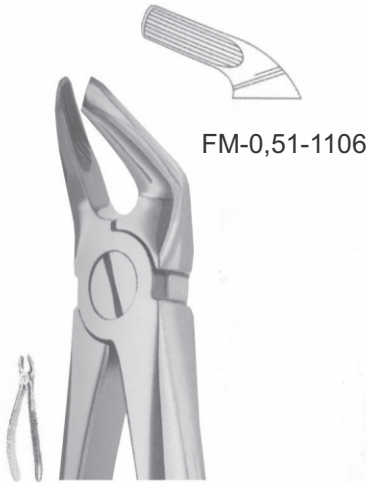

Fig. 8



Fig. 13

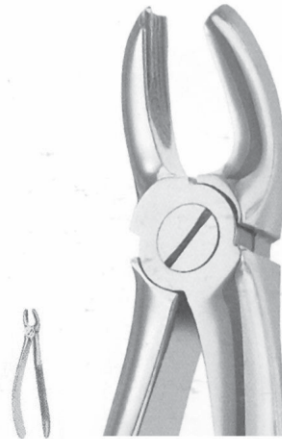

Fig. 17



Fig. 18



Fig. 18 A



Fig. 19

EN	Extracting Forceps English Pattern
DE	Zange extrahieren englisches Muster
ES	Extracto de fórceps patrón inglés
FR	Forceps d'extraction modèle anglais
IT	Estrazione del forcipe modello inglese

EXTRACTION



Fig. 20



FM-0,51-1112



Fig. 21



FM-0,51-1113

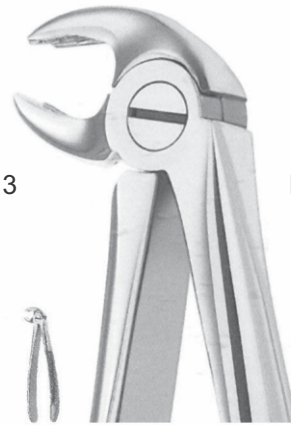

Fig. 22



FM-0,51-1114



Fig. 23



FM-0,51-1115



Fig. 24

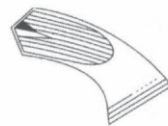

FM-0,51-1116

Extracting Forceps English Pattern	EN
Zange extrahieren englisches Muster	DE
Extracto de fórceps patrón inglés	ES
Forceps d'extraction modèle anglais	FR
Estrazione del forcipe modello inglese	IT

51



EXTRACTION



FM-0,51-1117

Fig. 29



FM-0,51-1118

Fig. 29 N



FM-0,51-1119

Fig. 30



FM-0,51-1120

Fig. 31



FM-0,51-1121

Fig. 32

EN	Extracting Forceps English Pattern
DE	Zange extrahieren englisches Muster
ES	Extracto de fórceps patrón inglés
FR	Forceps d'extraction modèle anglais
IT	Estrazione del forcipe modello inglese



Fig. 33



FM-0,51-1122



Fig. 33 A



FM-0,51-1123



Fig. 33 C



FM-0,51-1124



Fig. 33 M



FM-0,51-1125



Fig. 33 W



FM-0,51-1126

Extracting Forceps English Pattern	EN
Zange extrahieren englisches Muster	DE
Extracto de fórceps patrón inglés	ES
Forceps d'extraction modèle anglais	FR
Estrazione del forcipe modello inglese	IT

51



EXTRACTION



FM-0,51-1127

Fig. 34



FM-0,51-1128

Fig. 35



FM-0,51-1129

Fig. 36

EN Extracting Forceps English Pattern
 DE Zange extrahieren englisches Muster
 ES Extracto de fórceps patrón inglés
 FR Forceps d'extraction modèle anglais
 IT Estrazione del forcipe modello inglese



EXTRACTION



Fig. 41

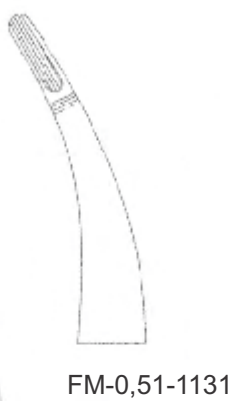
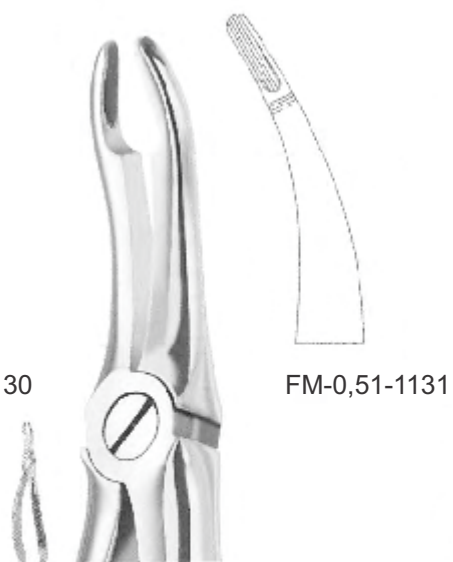

EN	Extracting Forceps English Pattern
DE	Zange extrahieren englisches Muster
ES	Extracto de fórceps patrón inglés
FR	Forceps d'extraction modèle anglais
IT	Estrazione del forcipe modello inglese

EXTRACTION



Fig. 51 M



Fig. 52

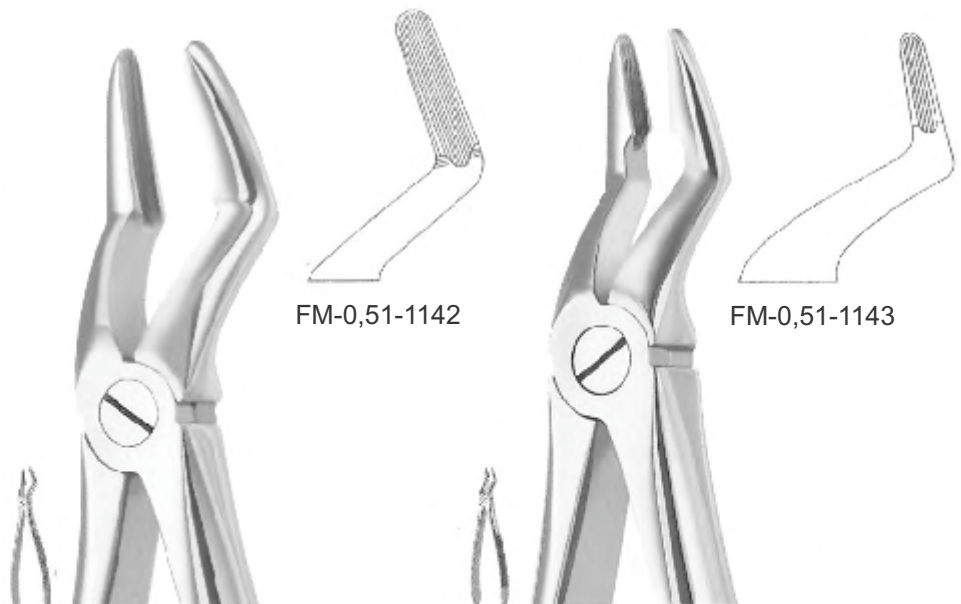

Fig. 52 A

Fig. 53

Extracting Forceps English Pattern	EN
Zange extrahieren englisches Muster	DE
Extracto de fórceps patrón inglés	ES
Forceps d'extraction modèle anglais	FR
Estrazione del forcipe modello inglese	IT

51



EXTRACTION



Fig. 55



Fig. 56

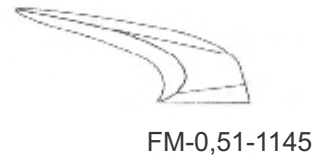

INSTRUMENTS CORPORATION

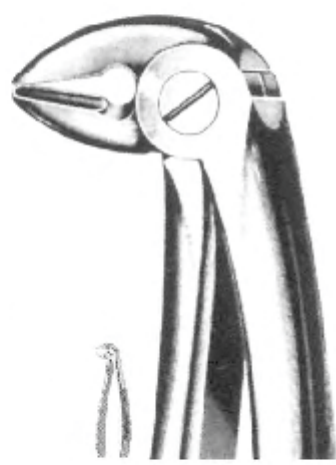

BUSCH
Fig. 59

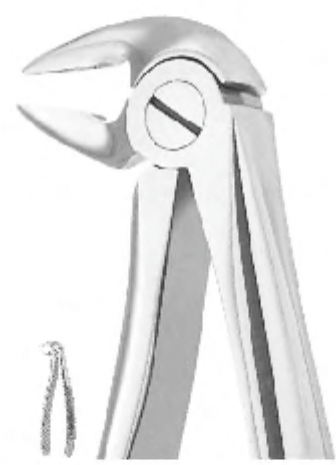

BUSCH
Fig. 60



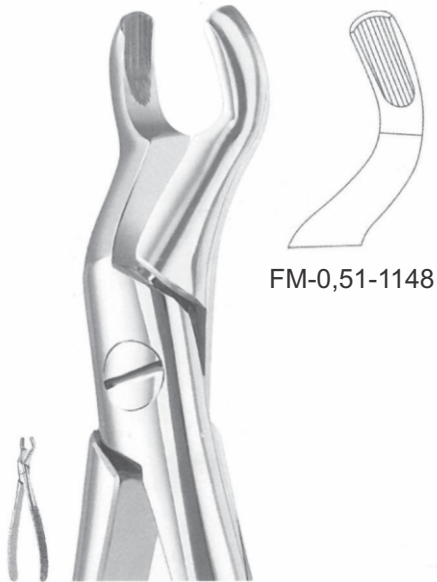

FM-0,51-1148

Fig. 67

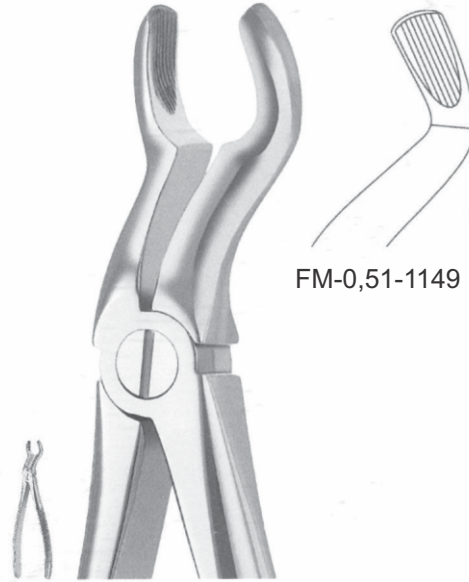

FM-0,51-1149

Fig. 67 A

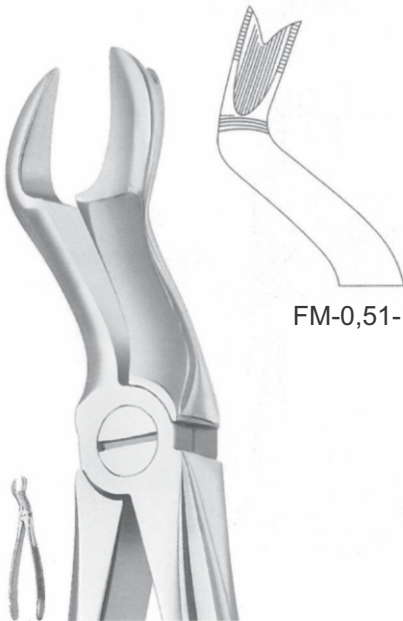

FM-0,51-1150

Fig. 67 LX

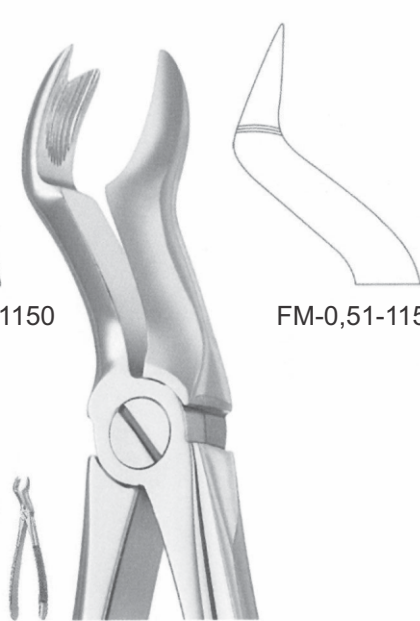

FM-0,51-1151

Fig. 67 RX

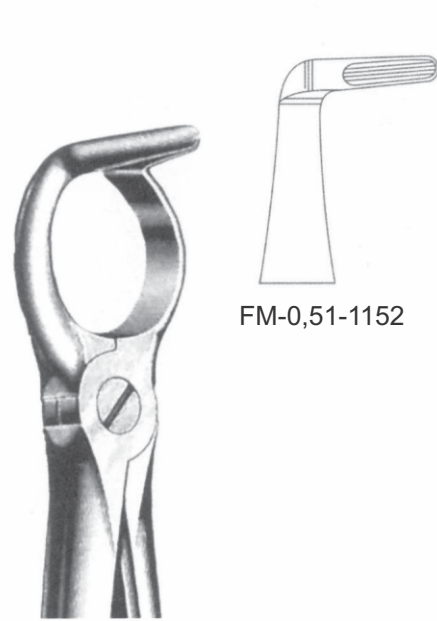

FM-0,51-1152

RYDING
Fig. 68



Fig. 73



FM-0,51-1153



Fig. 74



FM-0,51-1154

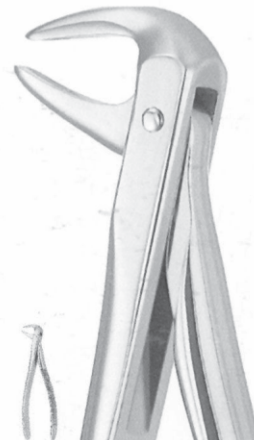

Fig. 74 M



FM-0,51-1155



Fig. 74N



FM-0,51-1156



Fig. 75



FM-0,51-1157

EN	Extracting Forceps English Pattern
DE	Zange extrahieren englisches Muster
ES	Extracto de fórceps patrón inglés
FR	Forceps d'extraction modèle anglais
IT	Estrazione del forcipe modello inglese



FM-0,51-1158

LAWRENCE-READ
Fig. 76

FM-0,51-1159

LAWRENCE-READ
Fig. 76 N

Extracting Forceps English Pattern	EN
Zange extrahieren englisches Muster	DE
Extracto de fórceps patrón inglés	ES
Forceps d'extraction modèle anglais	FR
Estrazione del forcipe modello inglese	IT

51



FAIZAN & MUSA
SURGICAL

EXTRACTION



Fig. 79



Fig. 79 A



Fig. 86 A



Fig. 86 B

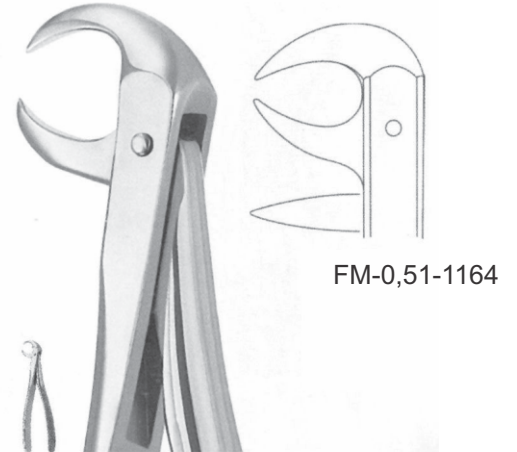

Fig. 86 C

EN Extracting Forceps English Pattern
 DE Zange extrahieren englisches Muster
 ES Extracto de fórceps patrón inglés
 FR Forceps d'extraction modèle anglais
 IT Estrazione del forcipe modello inglese



EXTRACTION



Fig. 87

Fig. 89

Fig. 90

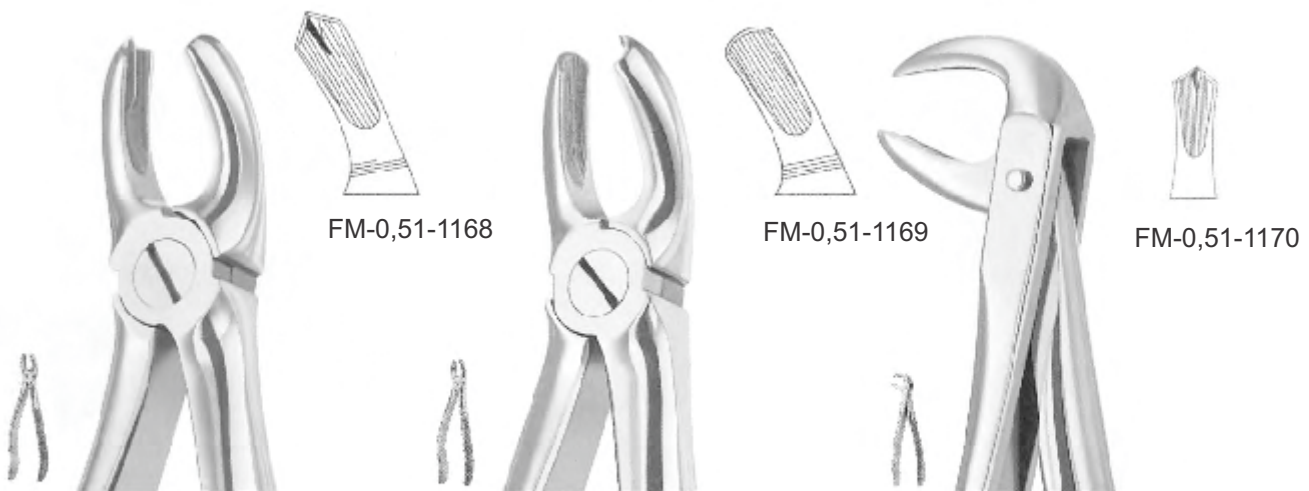

Fig. 94

Fig. 95

WOOD
Fig. 99



FM-0,51-1171

Fig. 113



FM-0,51-1172

OGDEN FELSCH
Fig. 121



FM-0,51-1173

GUY
Fig. 136



FM-0,51-1174

GUY
Fig. 137



FM-0,51-1175

Fig. 160



FM-0,51-1176

Fig. 162

EN	Extracting Forceps English Pattern
DE	Zange extrahieren englisches Muster
ES	Extracto de fórceps patrón inglés
FR	Forceps d'extraction modèle anglais
IT	Estrazione del forcipe modello inglese



FM-0,51-1177
Fig. 233



FM-0,51-1178



FM-0,51-1179
Fig. 235

Extracting Forceps English Pattern	EN
Zange extrahieren englisches Muster	DE
Extracto de fórceps patrón inglesa	ES
Forceps d'extraction modèle anglais	FR
Estrazione del forcipe modello inglese	IT

51



EXTRACTION



MEAD
Fig. MD 1

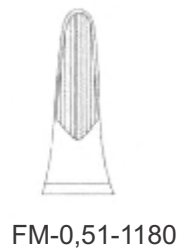

FM-0,51-1180



MEAD
Fig. MD 2



FM-0,51-1181



MEAD
Fig. MD 3



FM-0,51-1182



MEAD
Fig. MD 4



FM-0,51-1183

- EN Extracting Forceps English Pattern
- DE Zange extrahieren englisches Muster
- ES Extracto de fórceps patrón inglés
- FR Forceps d'extraction modèle anglais
- IT Estrazione del forcipe modello inglese



EXTRACTION



COHEN



FM-0,51-1184

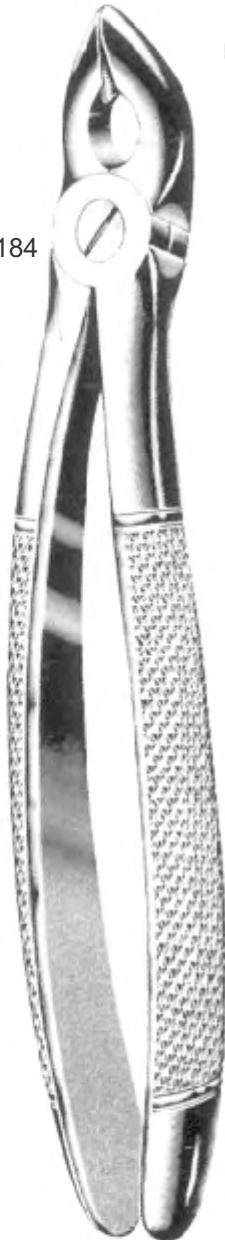

COHEN



FM-0,51-1185



STIKSA



FM-0,51-1186



STIKSA



FM-0,51-1187

Extracting Forceps English Pattern	EN
Zange extrahieren englisches Muster	DE
Extracto de fórceps patrón inglés	ES
Forceps d'extraction modèle anglais	FR
Estrazione del forcipe modello inglese	IT



Fig. 13 S



Fig. 22 S



Fig. 29 S



Fig. 30 S



Fig. 33 S



Fig. 37

EN	Extracting Forceps English Pattern
DE	Zange extrahieren englisches Muster
ES	Extracto de fórceps patrón inglés
FR	Forceps d'extraction modèle anglais
IT	Estrazione del forcipe modello inglese



EXTRACTION



Fig. 38



Fig. 39



Fig. 39 A



Fig. 39 L



Fig. 39 R



Extracting Forceps English Pattern	EN
Zange extrahieren englisches Muster	DE
Extracto de fórceps patrón inglés	ES
Forceps d'extraction modèle anglais	FR
Estrazione del forcipe modello inglese	IT

51



EXTRACTION

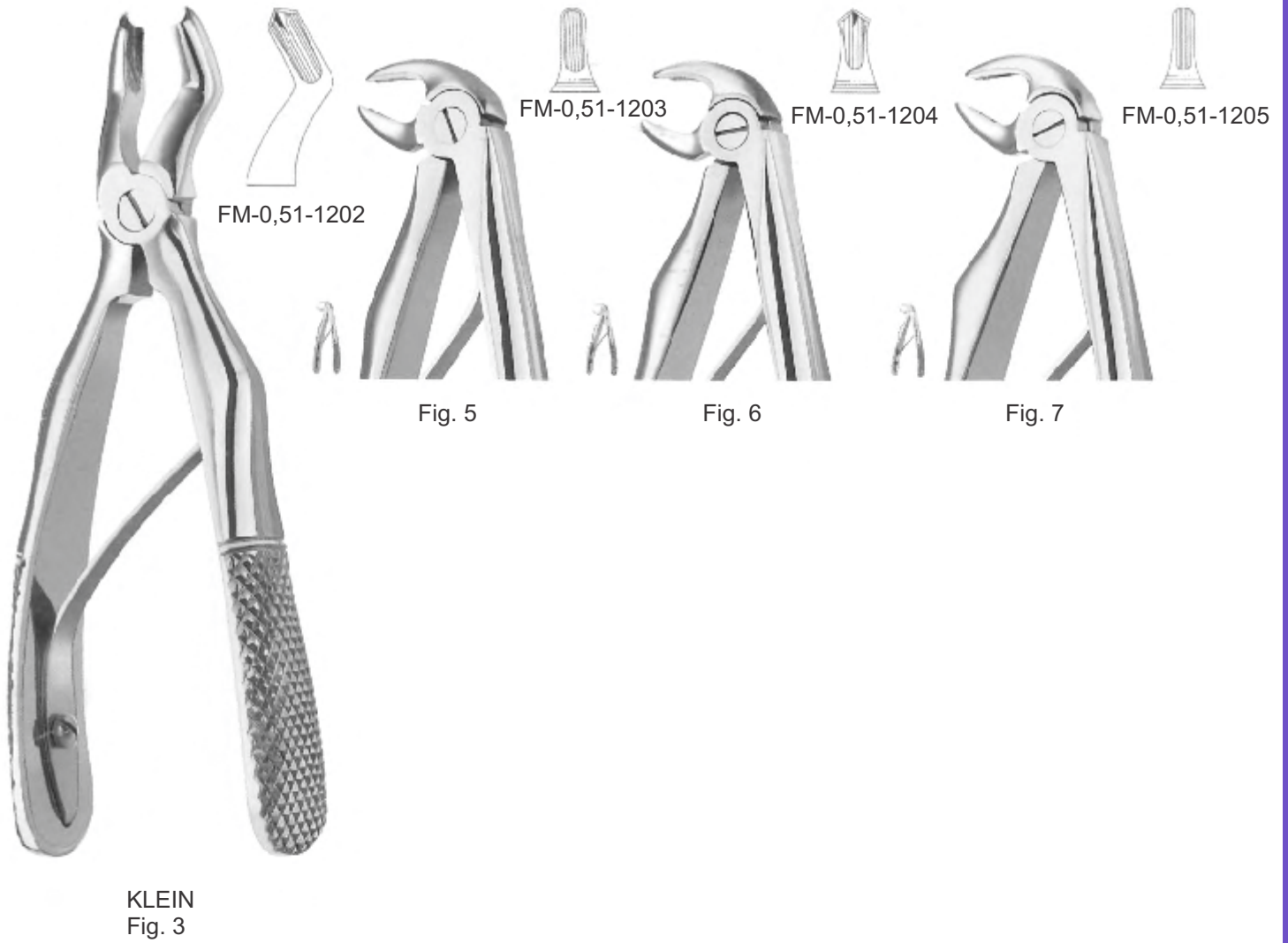

Fig. 40

Fig. 51 S

FM-0,51-1201
LAWRENCE-READ
Fig. 76 S

EN Extracting Forceps Kids, English Pattern
 DE Zange-Zangen extrahieren, englisches Muster
 ES Extracción de fórceps para niños, patrón inglés
 FR Forceps d'extraction enfants, modèle anglais
 IT Estrazione di forcipi per bambini, modello inglese



Extracting Forceps Kids, English Pattern	EN
Zange-Zangen extrahieren, englisches Muster	DE
Extracción de fórceps para niños, patrón inglés	ES
Forceps d'extraction enfants, modèle anglais	FR
Estrazione di forcipi per bambini, modello inglese	IT

51



FM-0,51-1206

KLEIN
Fig. 137



FM-0,51-1207

KLEIN
Fig. 139





FM-0,51-1208

KLEIN
Fig. 51 S

EN	Root Elevators
DE	Wurzelheber
ES	Elévatours á racines
FR	Botadores para raíces
IT	Leve per radici

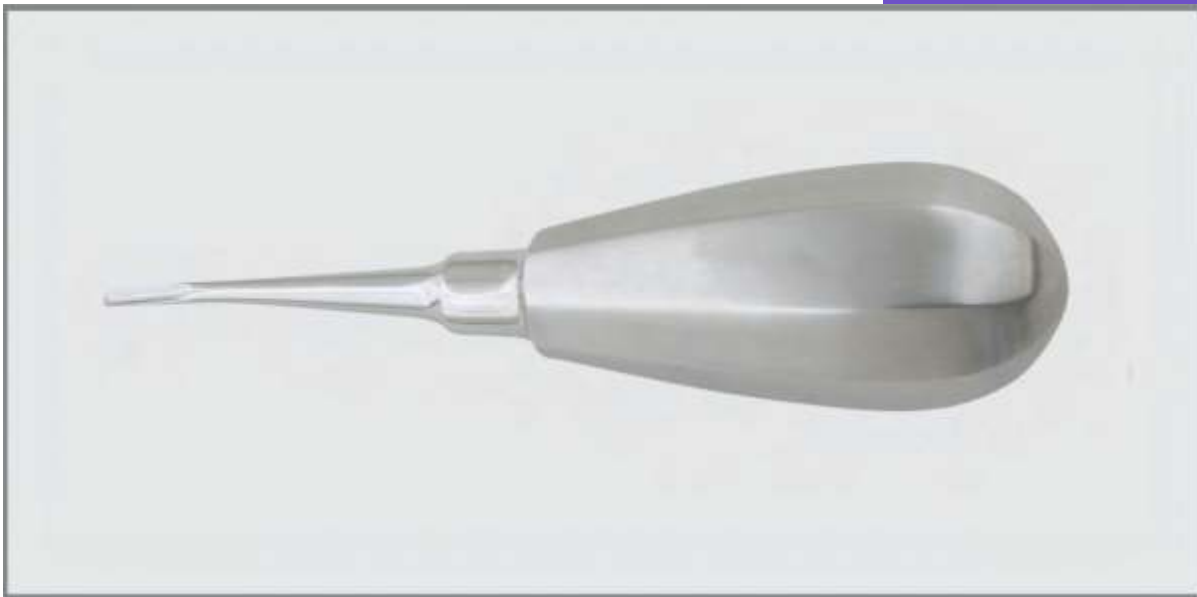
Page 40 to 54















EN	Root Elevators
DE	Wurzelaufzüge
ES	Elevadores De Raíz
FR	Élévateurs De Racines
IT	Elevatori Di Root



ROOT ELEVATORS

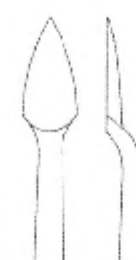

					
	FM-0,52-1251 Fig. 1 L	FM-0,52-1252 Fig. 1 R	SALDIN FM-0,52-1253 Fig. 2	SELDIN FM-0,52-1254 Fig. 3	CRYER FM-0,52-1255 Fig. 3 A
					
	SELDIN FM-0,52-1256 Fig. 4 L	SELDIN FM-0,52-1257 Fig. 4 R	CRANE (COGSWELL) FM-0,52-1258 Fig. 6	JMLLER FM-0,52-1259 Fig. 8	JMLLER FM-0,52-1260 Fig. 9
					
	JMLLER (Apexo) FM-0,52-1261 Fig. 10	JMLLER (Apexo) FM-0,52-1262 Fig.11	CRYER FM-0,52-1263 Fig. 12		



EN	Root Elevators
DE	Wurzelaufzüge
ES	Elevadores De Raíz
FR	Élévateurs De Racines
IT	Elevatori Di Root



ROOT ELEVATORS



APICAL (Apexo)
FM-52-1275
Fig. 301



FM-52-1276
Fig. 304



FM-52-1279
Fig. 1

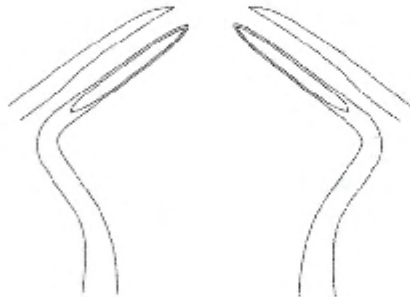

FM-52-1277
Fig. 302

FLOHR
FM-52-1278
Fig. 303



COLEMAN



FM-52-1280
Fig. 2 L



FM-52-1281
Fig. 3 R

Root Elevators **EN**

Wurzelaufzüge **DE**

Elevadores De Raíz **ES**

Élévateurs De Racines **FR**

Elevatori Di Root **IT**

52



ROOT ELEVATORS



WARWICK JAMES
FM-52-1282
16 cm/6 1/4"



RS-52-1283
Fig. 2 L



FM-52-1284
Fig. 3 L



KOPP

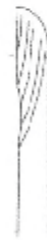

FM-52-1285
Fig. 1



FM-52-1286
Fig. 2



FM-52-1287
Fig. 3



FM-52-1288
Fig. 4

EN	Root Elevators
DE	Wurzelaufzüge
ES	Elevadores De Raíz
FR	Élévateurs De Racines
IT	Elevatori Di Root



ROOT ELEVATORS



KOPP



FM-52-1289
Fig. 1



FM-52-1290
Fig. 2



FM-52-1293
Fig. 1



FM-52-1291
Fig. 3



FM-52-1292
Fig. 4



FM-52-1294
Fig. 2



FM-52-1295
Fig. 3



FLOHR

Root Elevators **EN**

Wurzelaufzüge **DE**

Elevadores De Raíz **ES**

Élévateurs De Racines **FR**

Elevatori Di Root **IT**

52



ROOT ELEVATORS



FRIEDMAN
FM-52-1296
Fig 1



FM-52-1297
Fig. 2 L



FM-52-1298
Fig. .3 R



HYLIN
FM-52-1299
Fig. 1



FM-52-1301
Fig. 3 L



FM-52-1302
Fig. 4 R



FM-52-1300
Fig. 2

EN	Root Elevators
DE	Wurzelaufzüge
ES	Elevadores De Raíz
FR	Élévateurs De Racines
IT	Elevatori Di Root



ROOT ELEVATORS

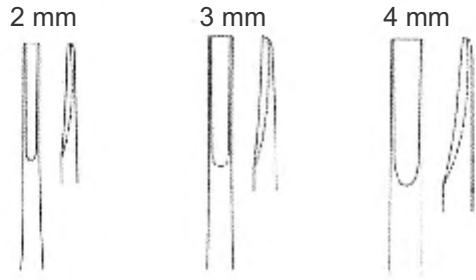

2 mm 3 mm 4 mm
 FM-52-1303 BEIN FM-52-1304 FM-52-1305
 Fig.0 Fig. 1 Fig. 2

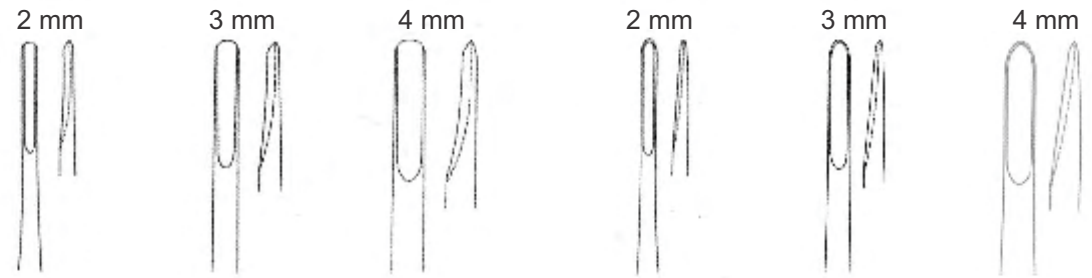

2 mm 3 mm 4 mm 2 mm 3 mm 4 mm
 FM-52-1306 BEIN FM-52-1307 FM-52-1308 FM-52-1309 BEIN FM-52-1310 FM-52-1311
 Fig. 0 Fig. 1 Fig. 2 Fig. 0 Fig. 1 Fig. 2

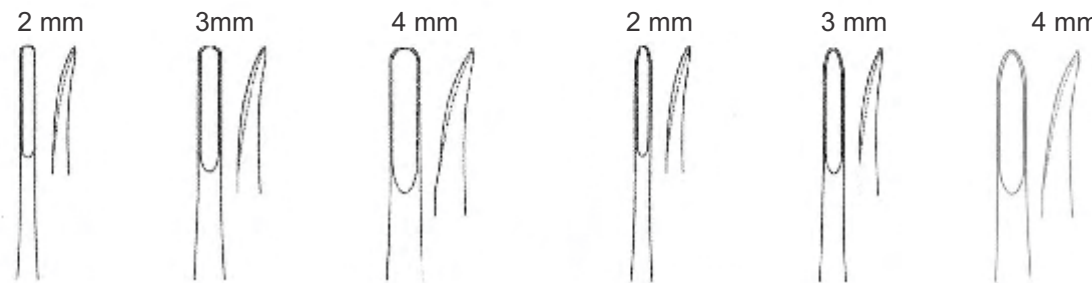

2 mm 3mm 4 mm 2 mm 3 mm 4 mm
 FM-52-1312 BEIN FM-52-1313 FM-52-1314 FM-52-1315 BEIN FM-52-1316 FM-52-1317
 Fig. 0 A Fig. 1 A Fig.2 A Fig.0 A Fig. 1 A Fig. 2 A

Root Elevators EN

Wurzelaufzüge DE

Elevadores De Raíz ES

Élévateurs De Racines FR

Elevatori Di Root IT

52



ROOT ELEVATORS



COUPLAND

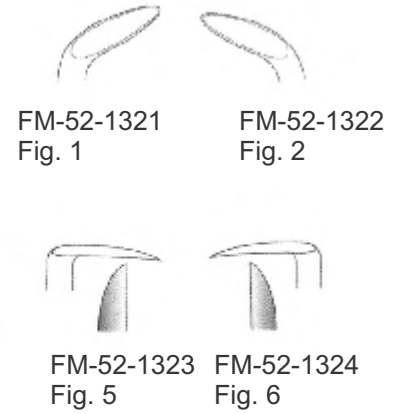
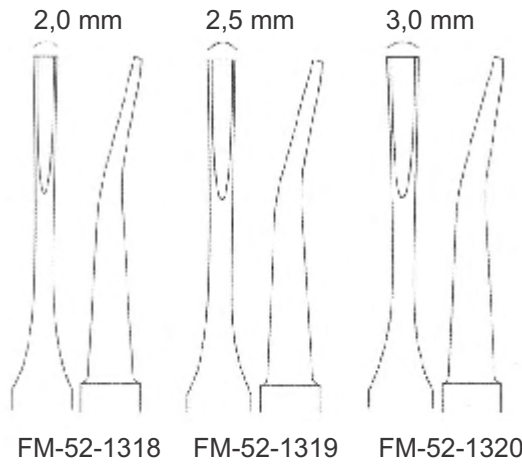

LOOS



FM-52-1325 Fig. 1



FM-52-1326 Fig. 2

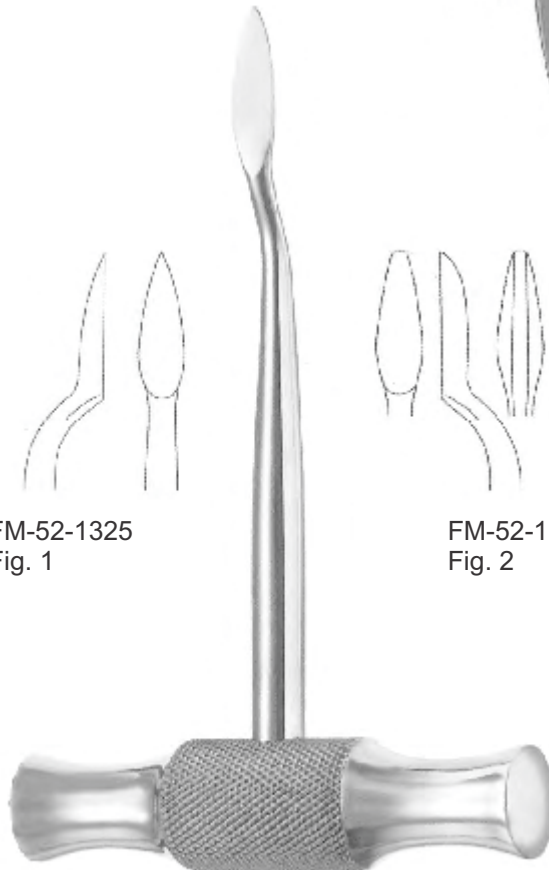

LECLUSE

EN	Root Elevators
DE	Wurzelaufzüge
ES	Elevadores De Raíz
FR	Élévateurs De Racines
IT	Elevatori Di Root

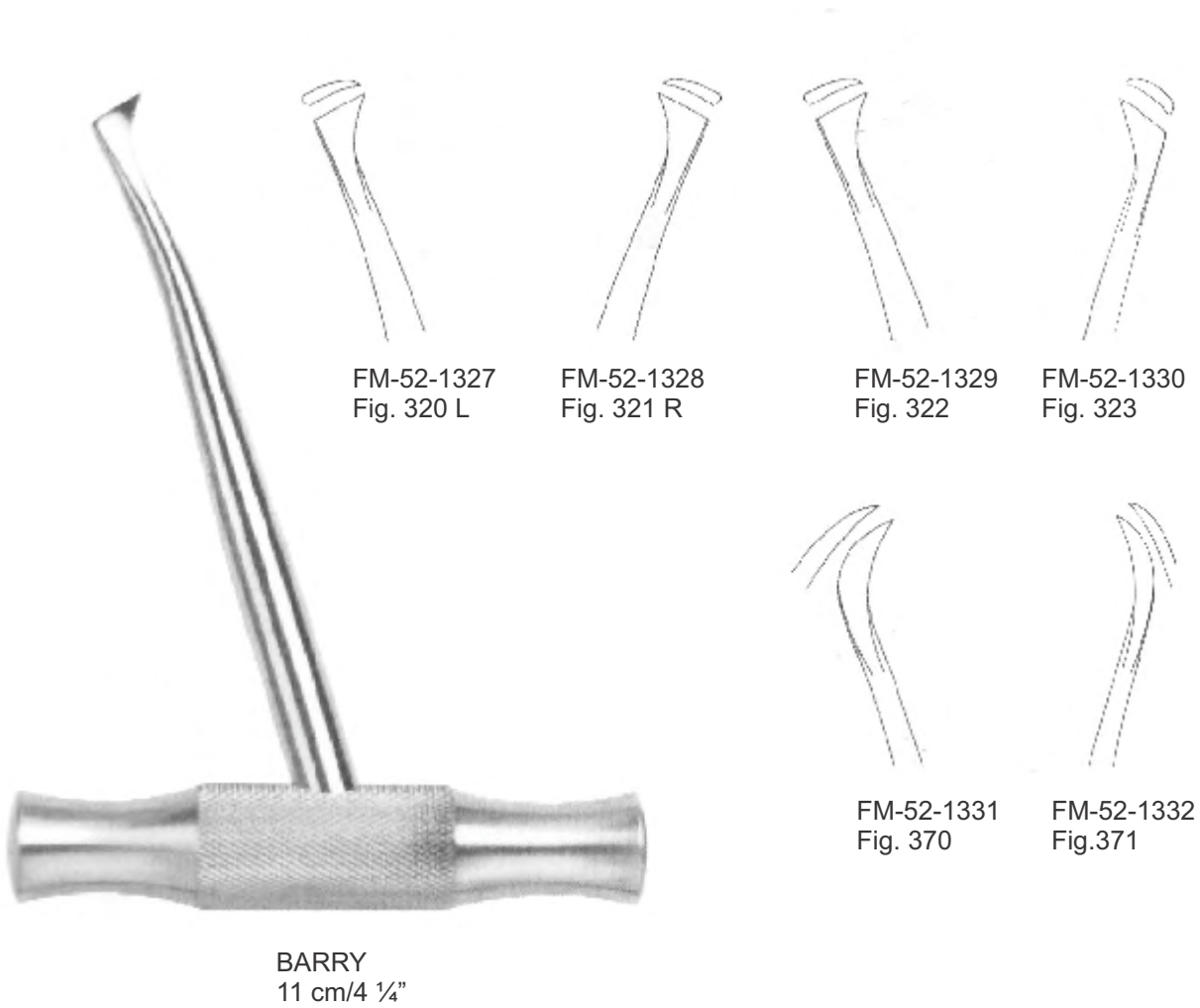

Root Elevators **EN**
 Wurzelauflüger **DE**
 Elevadores De Raíz **ES**
 Élévateurs De Racines **FR**
 Elevatori Di Root **IT**

52



ROOT ELEVATORS



FM-52-1333
Fig. 1 L



FM-52-1334
Fig. 1 R



FM-52-1335
Fig. 11 L



FM-52-1336
Fig. 11 R



FM-52-1337
Fig. 12 L



FM-52-1338
Fig. 12 R



WINTER
11 cm/4 1/4"



FM-52-1339
Fig. 13 L



FM-52-1340
Fig. 13 R



FM-52-1341
Fig. 14 L



FM-52-1342
Fig. 14 R

EN	Root Elevators
DE	Wurzelaufzüge
ES	Elevadores De Raíz
FR	Élévateurs De Racines
IT	Elevatori Di Root

ROOT ELEVATORS



CHOMPRET



FM-52-1343
Fig. 1



FM-52-1344
Fig. 2



FM-52-1345
Fig. 3



FM-52-1346
Fig. 4



BERNARD



FM-52-1347
Fig. 0



FM-52-1348
Fig. 1

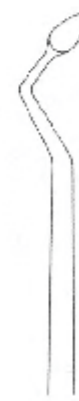

FM-52-1349
Fig. 2



FM-52-1350
Fig. 6



FM-52-1351
Fig. 7



FM-52-1352
Fig. 11

Root Elevators EN

Wurzelaufzüge DE

Elevadores De Raíz ES

Élévateurs De Racines FR

Elevatori Di Root IT

52



ROOT ELEVATORS



BERNARD
Handle # A

BERNARD
Handle # B



FM-52-1353
Fig. 1



FM-52-1354
Fig. 2



FM-52-1355
Fig. 3



FM-1356
Fig. 4



FM-52-1357
Fig. 5



RS-52-1358
Fig. 10



FM-52-1359
Fig. 8



FM-52-1360
Fig. 9



FM-52-1361
Fig. 11



FM-52-1362
Fig. 7



FM-52-1363
Fig. 6

EN	Root Elevators
DE	Wurzelaufzüge
ES	Elevadores De Raíz
FR	Élévateurs De Racines
IT	Elevatori Di Root

ROOT ELEVATORS



HEIDBRINK



FM-52-1366
Fig. 1



FM-52-1367
Fig. 2



FM-52-1368
Fig. 3



WEST (Apical)



FM-52-1369
Fig. 1



FM-52-1370
Fig. 2 R



FM-52-1371
Fig. 3 L

Root Elevators **EN**

Wurzelaufzüge **DE**

Elevadores De Raíz **ES**

Élévateurs De Racines **FR**

Elevatori Di Root **IT**

52



ROOT ELEVATORS



RATZOW



FM-52-1372
Fig. 1



FM-52-1373
Fig. 2



FM-52-1374
Fig. 3



HEIDBRINK



FM-52-1375
Fig. 1



FM-52-1376
Fig. 2

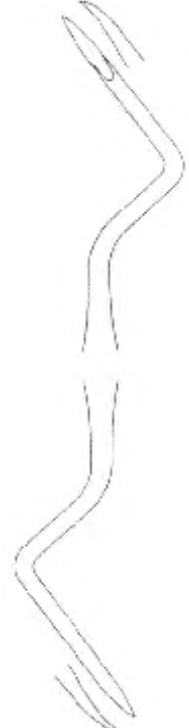

FM-52-1377
Fig. 23

EN	Root Elevators
DE	Wurzelaufzüge
ES	Elevadores De Raíz
FR	Élévateurs De Racines
IT	Elevatori Di Root



ROOT ELEVATORS



VIGNAL



FM-52-1378
Fig. 54



FM-52-1379
Fig. 55



FM-52-1380
Fig.56



FM-52-1381
Fig.57



FM-52-1382
Fig. 69

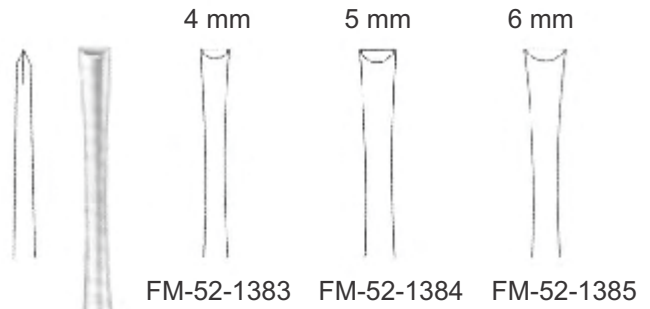

BARRY
21.5 cm/8 3/4"

EN	Bone Files
DE	Bone-Dateien
ES	Archivos de huesos
FR	Fichiers d'os
IT	Bone Files

Page 55 to 56



EN	Bone files
DE	Knochenfeilen
ES	Limes à os
FR	Lima para huesos
IT	Lima per ossa



BONE FILES



JMLLER-COLBURN
18 cm/7"

downwards cutting



Fig. 1

FM-53-1401

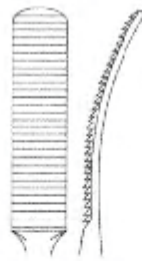

Fig. 2

FM-53-1402

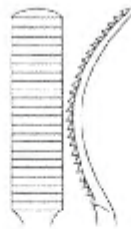

Fig. 3

FM-53-1403



Fig. 4

FM-53-1404

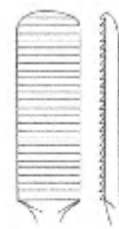

Fig. 5

FM-53-1405

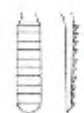
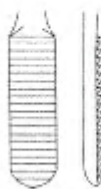

Fig. 1

FM-53-1406

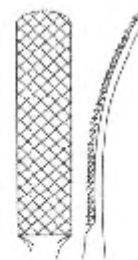

Fig. 2

FM-53-1407

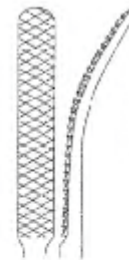

Fig. 3

FM-53-1408

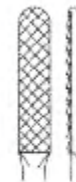
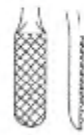
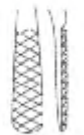

Fig. 4

FM-53-1409



cross cut



JMLLER-COLBURN
18 cm/7"

Bone files	EN
Knochenfeilen	DE
Limes à os	ES
Lima para huesos	FR
Lima per ossa	IT

53



BONE FILES



SELDIN
FM-53-1410
18 cm/7"
Fig. 11



SELDIN
FM-53-1411
18 cm/7"
Fig. 12

EN	Dental Probes
DE	Zahnsonden
ES	Sondas dentales
FR	Sondes dentaires
IT	Sonde dentali

Page 57 to 58



EN	Probes - Single Ended
DE	Sonden - Single Ended
ES	Sondas - terminación simple
FR	Sondes - Single Ended
IT	Sonde - Single Ended



DENTAL PROBES

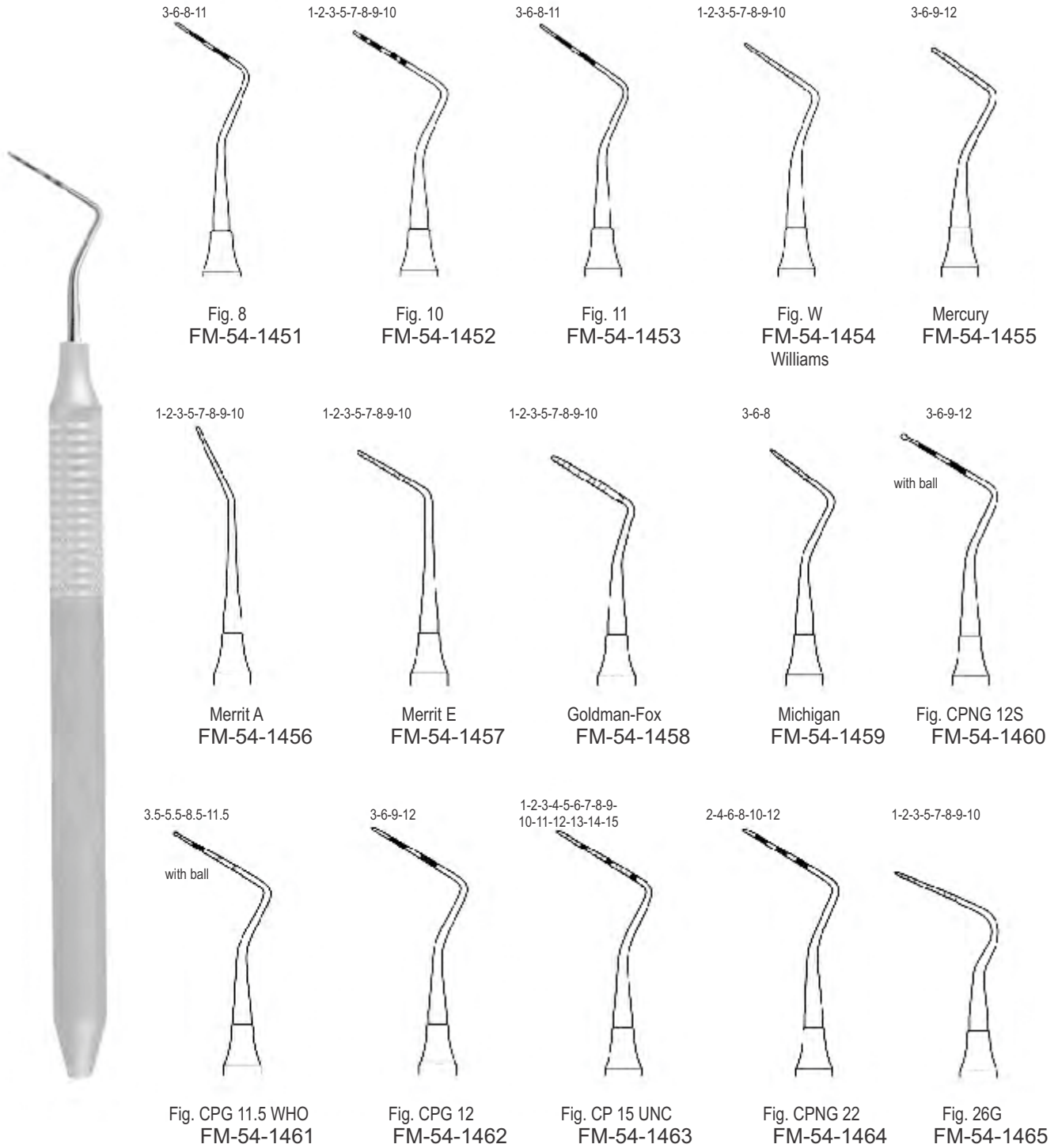

Probes - Double Ended **EN**
 Sonden - Doppelt beendete **DE**
 Sondas - Doble nal **ES**
 Sondes - Double n **FR**
 Sonde - Double Ended **IT**

1-2-3-5-7-8-9-10
FLAT



Goldman-Fox
Williams
FM-54-1466

3-6-9-12

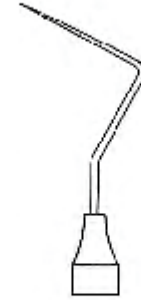

Fig. UT 3/4
Cattoni
FM-54-1467



12-9-6-3

1-2-3-5-7-8-9-10
FLAT

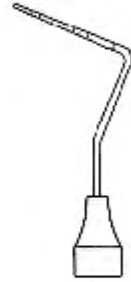

Fig. 3N
Nabers
FM-54-1468



10-9-8-7-5-3-2-1

1-2-3-5-7-8-9-10



Williams DE
Offset
FM-54-1469



10-9-8-7-5-3-2-1

3-6-9-12



Fig. CP 12/Thin
Williams
FM-54-1470



10-9-8-7-5-3-2-1



Nabers Furcation
probes graduated
working end
FM-54-1471



EN	Enamel Instruments
DE	Emaile-Instrumente
ES	Instrumentos de esmalte
FR	Instruments d'émail
IT	Strumenti per smalto

Page 59 to 62



EN	Chisels
DE	Meißel
ES	Cinceles
FR	Ciseaux
IT	scalpelli

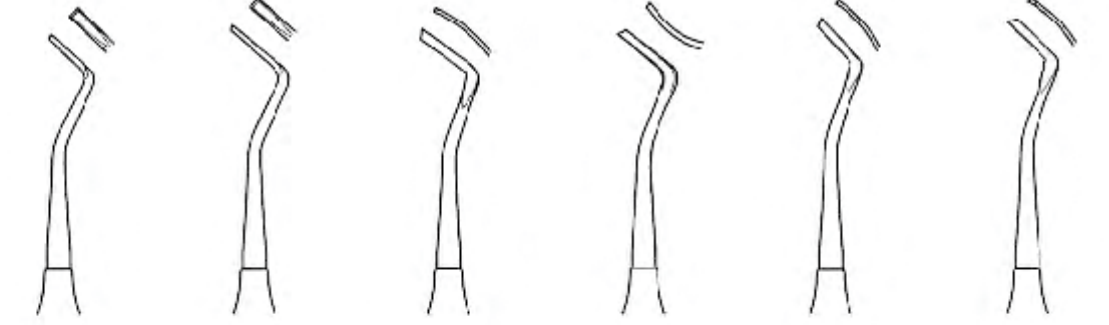

FM-55-1501 Fig. 1 Black	FM-55-1502 Fig. 2 Black	FM-55-1503 Fig. 26 Black	FM-55-1504 Fig. 27 Black	FM-55-1505 Fig. 28 Black	FM-55-1506 Fig. 29 Black
-------------------------------	-------------------------------	--------------------------------	--------------------------------	--------------------------------	--------------------------------



Chisels **EN**
 Meißel **DE**
 Cinceles **ES**
 Ciseaux **FR**
 scalpelli **IT**

55



FM-55-1507
 Fig. 51/52
 Black



FM-55-1508
 Fig. 53/54
 Black



FM-55-1509
 Fig. 63/64
 Black



FM-55-1510
 Fig. 65/66
 Black



FM-55-1511
 Fig. 1/2
 Wedelstaedt



FM-55-1512
 Fig. 3/4
 Wedelstaedt



FM-55-1513
 Fig. 5/6
 Wedelstaedt



EN	Hatchets
DE	Beile
ES	Hatchets
FR	Hachettes
IT	Hatchets

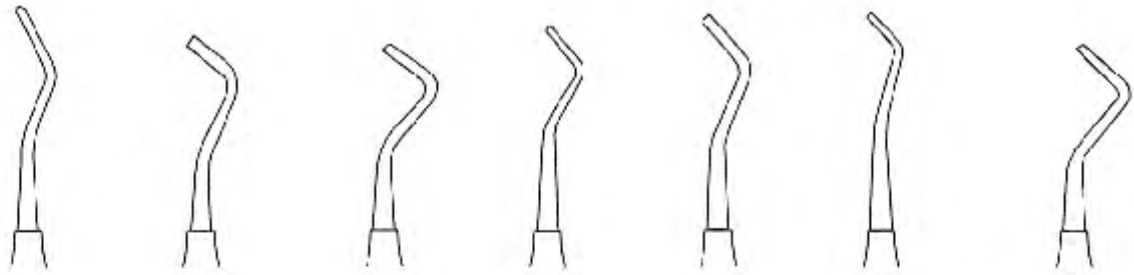

FM-55-1514
Fig. 8/9H

FM-55-1515
Fig. 13/14

FM-55-1516
Fig. 15/16

FM-55-1517
Fig. 17/18

FM-55-1518
Fig. 51/52

FM-55-1519
Fig. 53/54

FM-55-1520
Fig. 14/14
Off Angle



Chisels **EN**
 Meißel **DE**
 Cinceles **ES**
 Ciseaux **FR**
 scalpelli **IT**

55



ENAMEL INSTRUMENTS

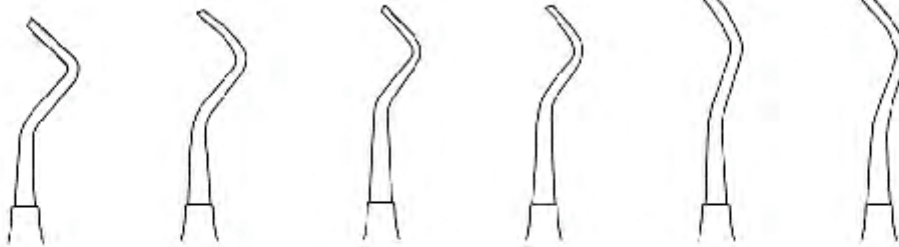

FM-55-1521
 Fig. 26
 Dista

FM-55-1522
 Fig. 27
 Mesial

FM-55-1523
 Fig. 28
 Distal

FM-55-1524
 Fig. 29
 Mesial

FM-55-1525
 Fig. 77/78
 Distal

FM-55-1526
 Mesial
 54-1142-00



EN	Dental Scalers
DE	Zahnsteinentferner
ES	Escaladores dentales
FR	Scalers dentaires
IT	Scaler dentali

Page 63 to 78



EN	Explorers - Single Ended
DE	Forscher - Single Ended
ES	Explorers - Single Finded
FR	Explorateurs - Single Ended
IT	Esploratori - Single Ended

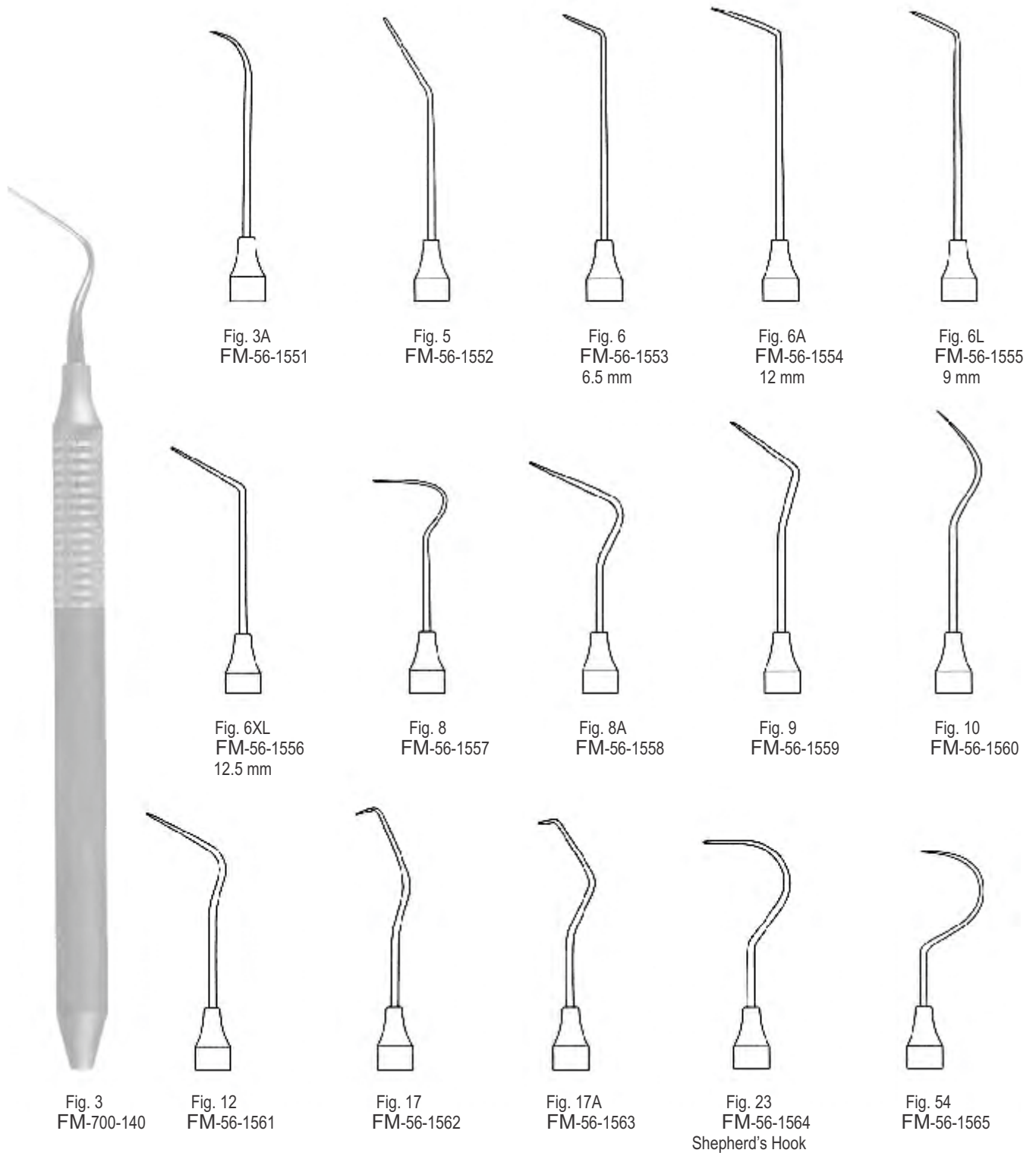

Explorers - Double Ended	EN
Forscher - Doppelt beendete	DE
Exploradores - Doble final	ES
Explorers - Double Ended	FR
Esploratori - Double Ended	IT



Fig. UT 1/2
56-1566



Fig. UT 2/2
FM-56-1567



Fig. 3CH/3CH
FM-56-1568



Fig. 6/3
FM-56-1569



Fig. 16/3
FM-56-1570



Fig. 2
FM-56-1571



EN	Explorers - Double Ended
DE	Forscher - Doppelt beendigt
ES	Exploradores - Doble nal
FR	Explorers - Double Ended
IT	Esploratori - Double Ended



Fig. 23/17
56-1572



Fig. 2A
FM-56-1573



Fig. 3
FM-56-1574



Fig. 1N
FM-56-1575
Nabers



Fig. 2N
FM-56-1576
Nabers



Fig. 5/6
FM-56-1577



Explorers - Double Ended	EN
Forscher - Doppelt beendete	DE
Exploradores - Doble final	ES
Explorers - Double Ended	FR
Esploratori - Double Ended	IT



Fig. 16/23
FM-56-1578



Fig. 6/23
FM-56-1579



Fig. 6/17
FM-56-1580



Fig. 23/17A
FM-56-1581



Fig. 3/23
FM-56-1582



EN	Gracey Curettes
DE	Gracey Küretten
ES	Gracey Curettes
FR	Curettes Gracey
IT	Gracey Curettes



DENTAL SCALERS



FM-56-1583
Fig. 1/2



FM-56-1584
Fig. 3/4



FM-56-1585
Fig. 5/6



FM-56-1586
Fig. 7/8



Gracey Curettes	EN
Gracey Küretten	DE
Gracey Curettes	ES
Curettes Gracey	FR
Gracey Curettes	IT



FM-56-1587
Fig. 9/10



FM-56-1588
Fig. 11/12



FM-56-1589
Fig. 13/14



FM-56-1590
Fig. 15/16

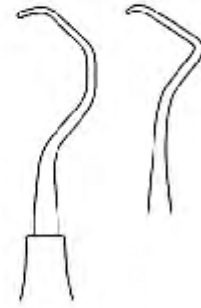

FM-56-1591
Fig. 17/18

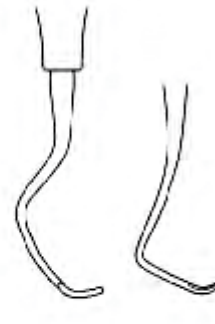

EN	Universal Curettes
DE	Universalküretten
ES	Curetas universales
FR	Curettes universelles
IT	Curette universali



Langer
FM-56-1592
Fig. 1/2

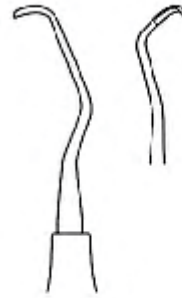

Langer
FM-56-1593
Fig. 3/4



Langer
FM-56-1594
Fig. 5/6



Langer
FM-56-1595
Fig. 17/18



Universal curettes are designed for easy adaptation on all tooth surfaces (thus the name "universal").

The blade of a universal curette has a round toe and back, and two cutting edges for scaling, making it an efficient design for scaling the entire mouth.

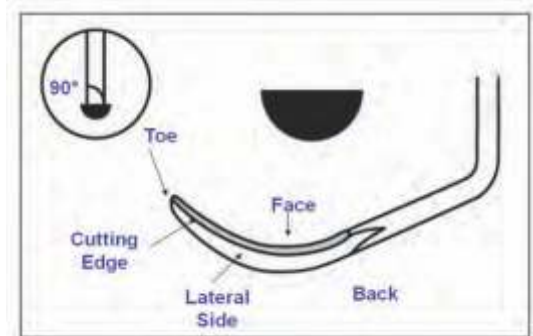

Universal Curettes **EN**
 Universalküretten **DE**
 Curetas universales **ES**
 Curettes universelles **FR**
 Curette universali **IT**

56



DENTAL SCALERS



Columbia
FM-56-1596
Fig. 13/14



Columbia
FM-56-1597
Fig. 2R/2L



Columbia
FM-56-1598
Fig. 4R/4L



FM-56-1599
Fig. Gx4



Barnhart
FM-56-1600
Fig. 1/2



Barnhart
FM-56-1601
Fig. 5/6



EN	Universal Curettes
DE	Universalküretten
ES	Curetas universales
FR	Curettes universelles
IT	Curette universali

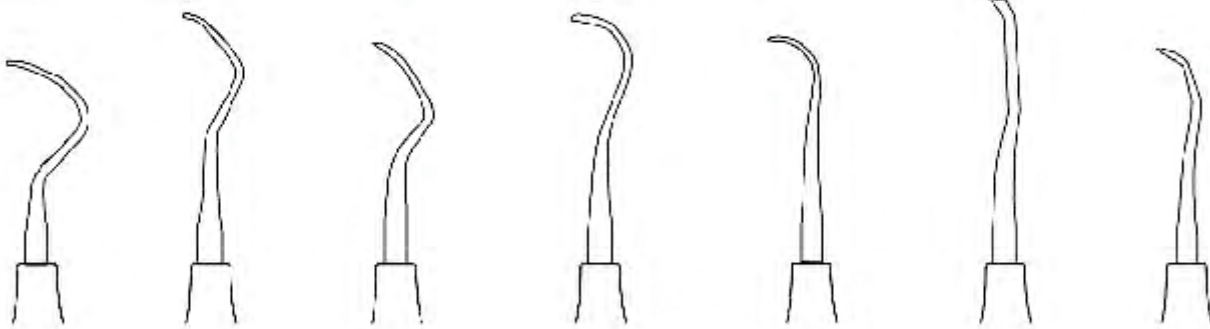

FM-56-1602
Fig. Me1

FM-56-1603
Rule [23-24]
Fig. 3/4

FM-56-1604
Fig. IU 13/14
Indiana University

FM-56-1605
Fig. IU 17/18
Indiana University

FM-56-1606
Fig. 7/8
Younger-Good

FM-56-1607
Fig. 1/2
Bunting

FM-56-1608
Fig. 5/6
Bunting





FM-56-1609
Fig. 1
Furcation curette



FM-56-1610
Fig. 2
Furcation curette



FM-56-1611
Fig. 3
Furcation curette



FM-56-1612
Fig. 4
Furcation curette



FM-56-1613
Fig. 5
Furcation curette



FM-56-1614
Fig. 1/2
Prichard



EN	Scalers / Curettes
DE	Scaler / Küretten
ES	Scalers / Curettes
FR	Scalers / Curettes
IT	Scaler / Curette

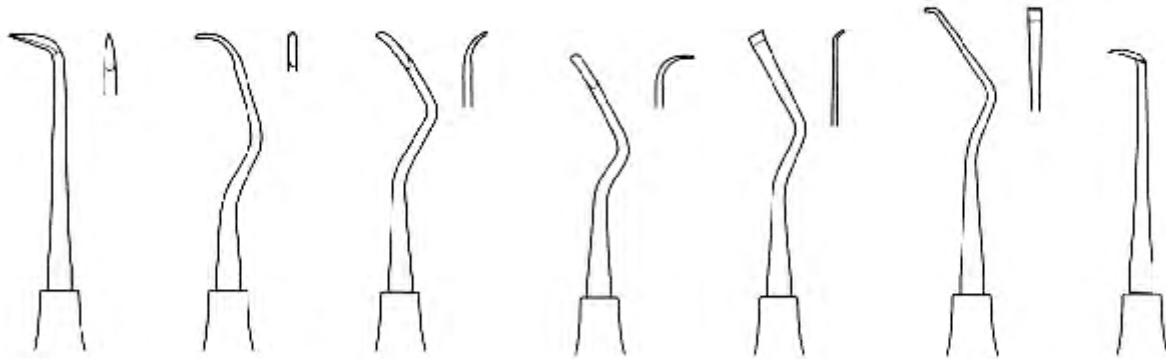

FM-56-1615 Goldman-Fox Fig. 1	FM-56-1616 Goldman-Fox Fig. 2	FM-56-1617 Goldman-Fox Fig. 3	FM-56-1618 Goldman-Fox Fig. 4	FM-56-1619 Goldman-Fox Fig. 5	FM-56-1620 Goldman-Fox Fig. 6	FM-56-1621 Goldman-Fox Fig. 21
-------------------------------------	-------------------------------------	-------------------------------------	-------------------------------------	-------------------------------------	-------------------------------------	--------------------------------------

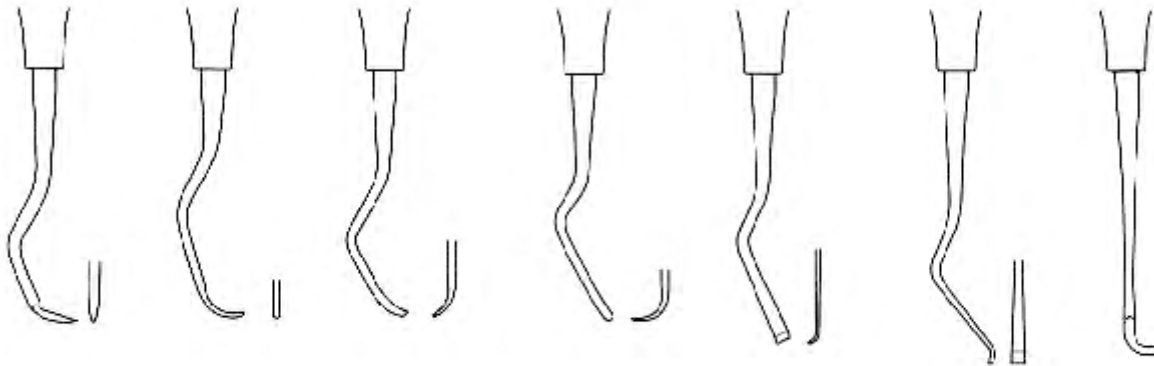

Scalers / Curettes	EN
Scaler / Küretten	DE
Scalers / Curettes	ES
Scalers / Curettes	FR
Scaler / Curette	IT

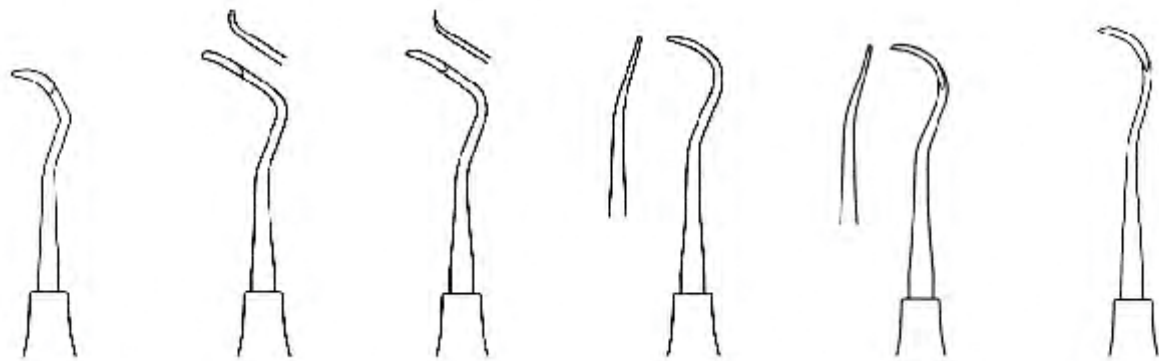

FM-56-1622
McCall
Fig. 11/12

FM-56-1623
McCall
Fig. 13S/14S

FM-56-1624
McCall
Fig. 13SM/14

FM-56-1625
McCall
Fig. 17/18

FM-56-1626
McCall
Fig. 17S/18S

FM-56-1627
McCall
Fig. 19/20

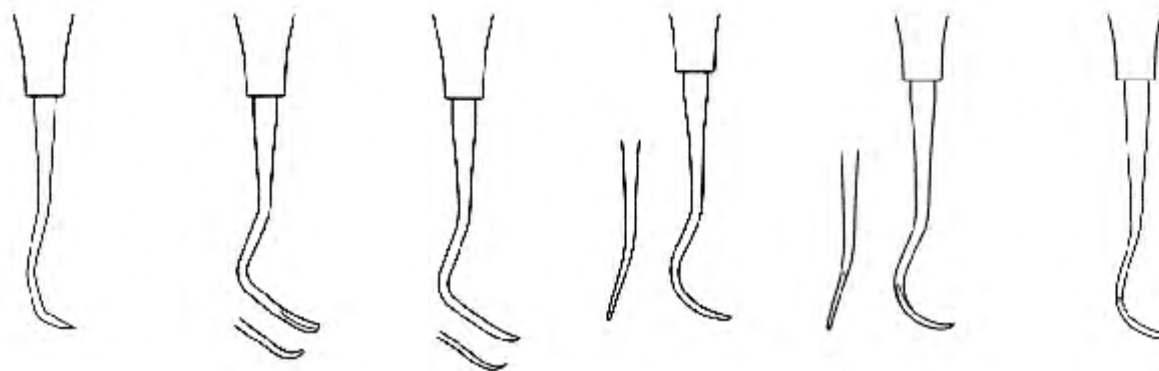

EN	Sickle Scaler
DE	Sichel-Scaler
ES	Escalador de hoz
FR	Scaler de faucille
IT	Sickle Scaler



DENTAL SCALERS

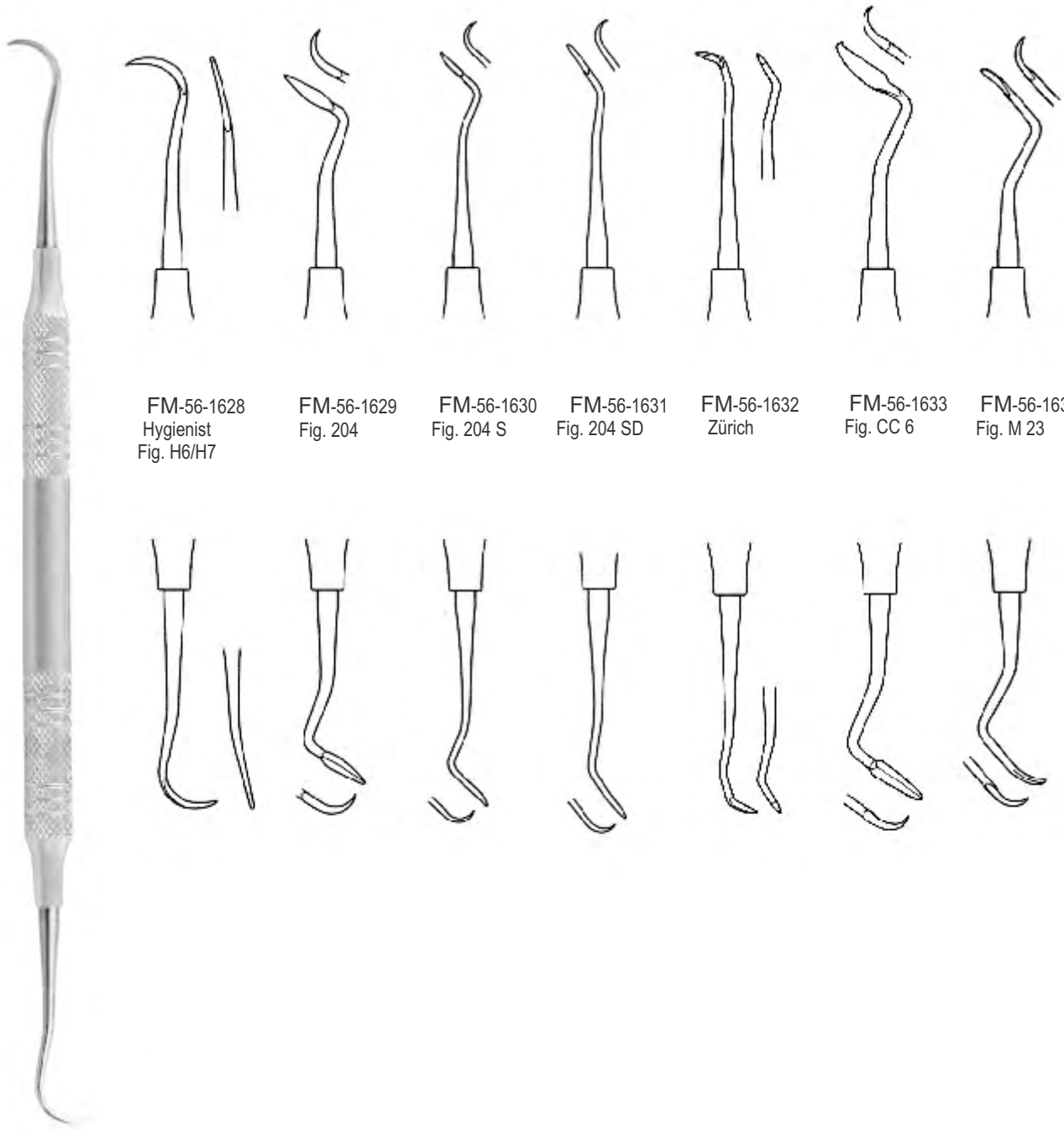

FM-56-1628
Hygienist
Fig. H6/H7

FM-56-1629
Fig. 204

FM-56-1630
Fig. 204 S

FM-56-1631
Fig. 204 SD

FM-56-1632
Zürich

FM-56-1633
Fig. CC 6

FM-56-1634
Fig. M 23

Sickle Scaler **EN**
 Sichel-Scaler **DE**
 Escalador de hoz **ES**
 Scaler de faucille **FR**
 Sickle Scaler **IT**

56



DENTAL SCALERS

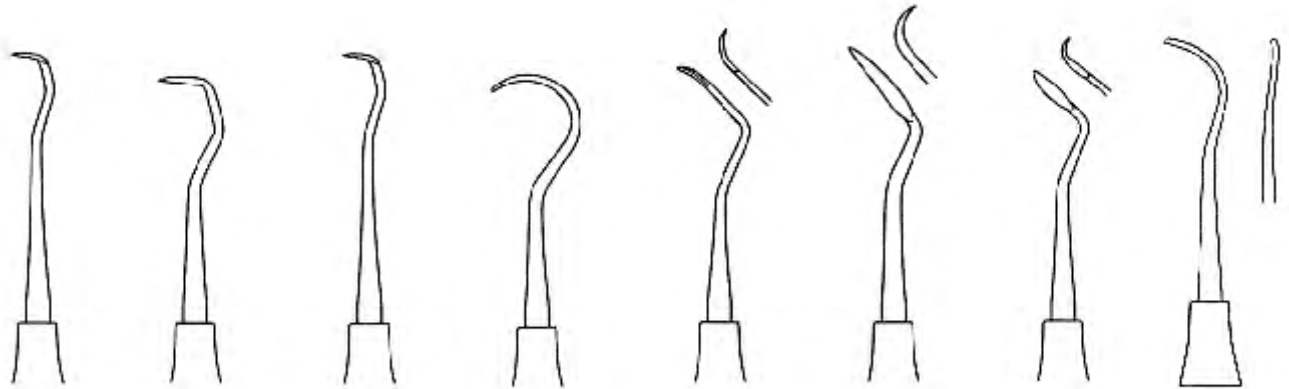

FM-56-1635 Hygienist-Towner Fig. H5/33
 FM-56-1636 Towner Fig. U15/30
 FM-56-1637 Towner Fig. U15/33
 FM-56-1638 Hygienist-Towner Fig. H5/U15
 FM-56-1639 Fig. U 135
 FM-56-1640 Fig. CI 2/3
 FM-56-1641 Taylor Fig. T2/T3
 FM-56-1642 Younger-Good Fig. 33/34

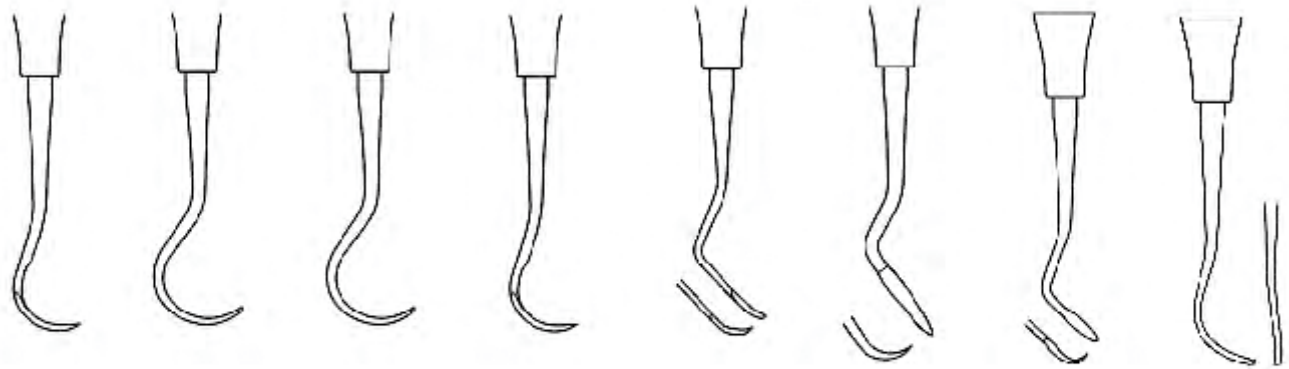

EN	Sickle Scaler
DE	Sichel-Scaler
ES	Escalador de hoz
FR	Scaler de faucille
IT	Sickle Scaler

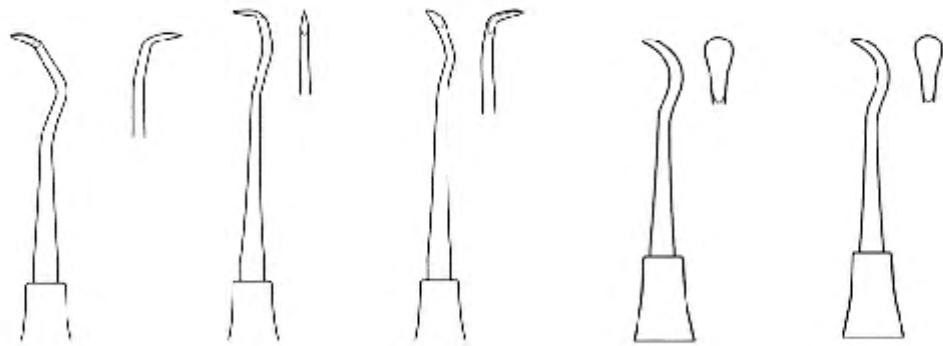

FM-56-1643
Jacquette
Fig. 31/32

FM-56-1644
Jacquette
Fig. 30/33

FM-56-1645
Jacquette
Fig. 34/35

FM-56-1646
Cumine
Fig. 33

FM-56-1647
Mitchell
Fig. 34

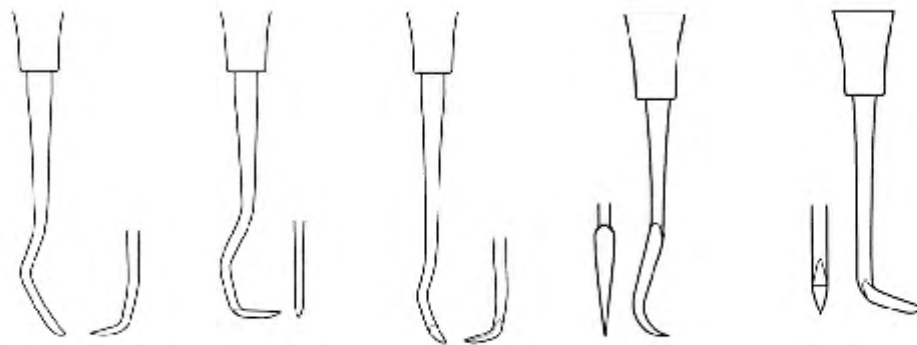

Sickle Scaler **EN**
 Sichel-Scaler **DE**
 Escalador de hoz **ES**
 Scaler de faucille **FR**
 Sickle Scaler **IT**

56



DENTAL SCALERS



FM-56-1648
Jacquette
Fig. 33



FM-56-1649
Jacquette
Fig. 34



FM-56-1650
Jacquette
Fig. 35



FM-56-1651
Ward-Kirkland
Fig. 1



FM-56-1652
Crane-Kaplan
Fig. 2



FM-56-1653
Mercitan
Fig. Sh5



FM-56-1654
Crane-Kaplan
Fig. 3



FM-56-1655
White
Fig. 12B

EN	Bone Curettes
DE	Knochenküretten
ES	Curetas de hueso
FR	Curettes osseuses
IT	Curette d'ossa

Page 79 to 84

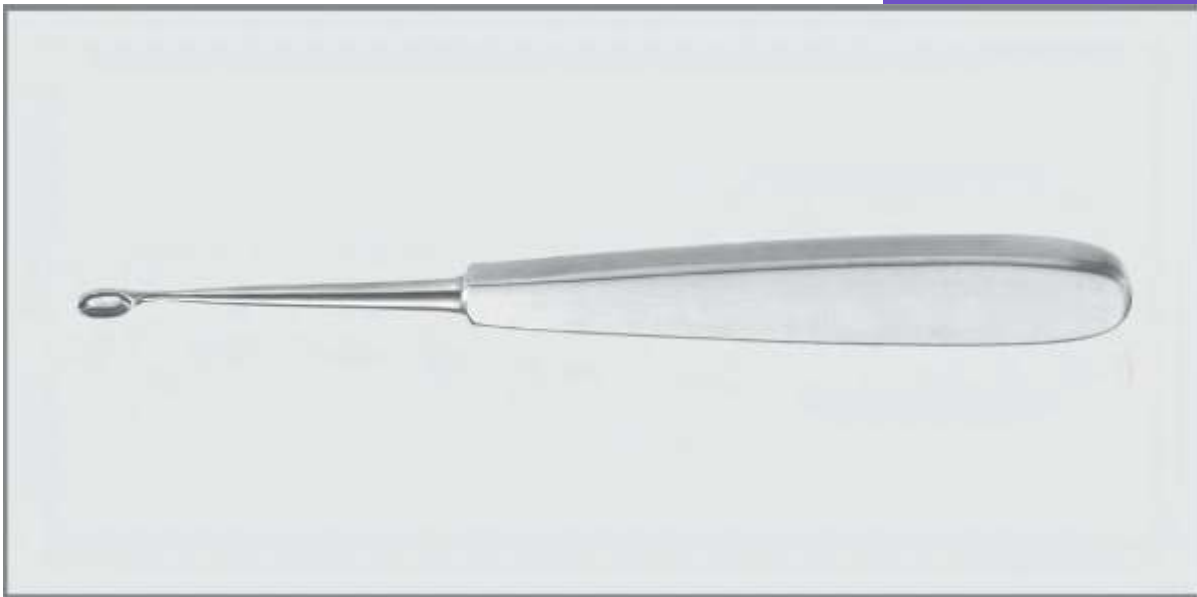

EN	Bone Currettes
DE	Scharf Löffel
ES	Curettes á os
FR	Cucharillas cortantes
IT	Curette taglienti



BONE CURETTES

FM-0,57-1701
FM-0,57-1702

FM-0,57-1703
FM-0,57-1704



WILLIGER

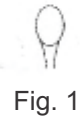
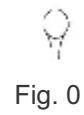
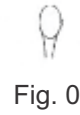
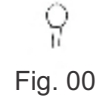

Fig. 00	FM-0,57-1705	FM-0,57-1709	FM-0,57-1713	FM-0,57-1717
Fig. 0	FM-0,57-1706	FM-0,57-1710	FM-0,57-1714	FM-0,57-1718
Fig. 1	FM-0,57-1707	FM-0,57-1711	FM-0,57-1715	FM-0,57-1719
Fig. 2	FM-0,57-1708	FM-0,57-1712	FM-0,57-1716	FM-0,57-1720

Bone Currettes **EN**
 Scharf Löffel **DE**
 Curettes á os **ES**
 Cucharillas cortantes **FR**
 Curette taglienti **IT**

57



BONE CURETTES

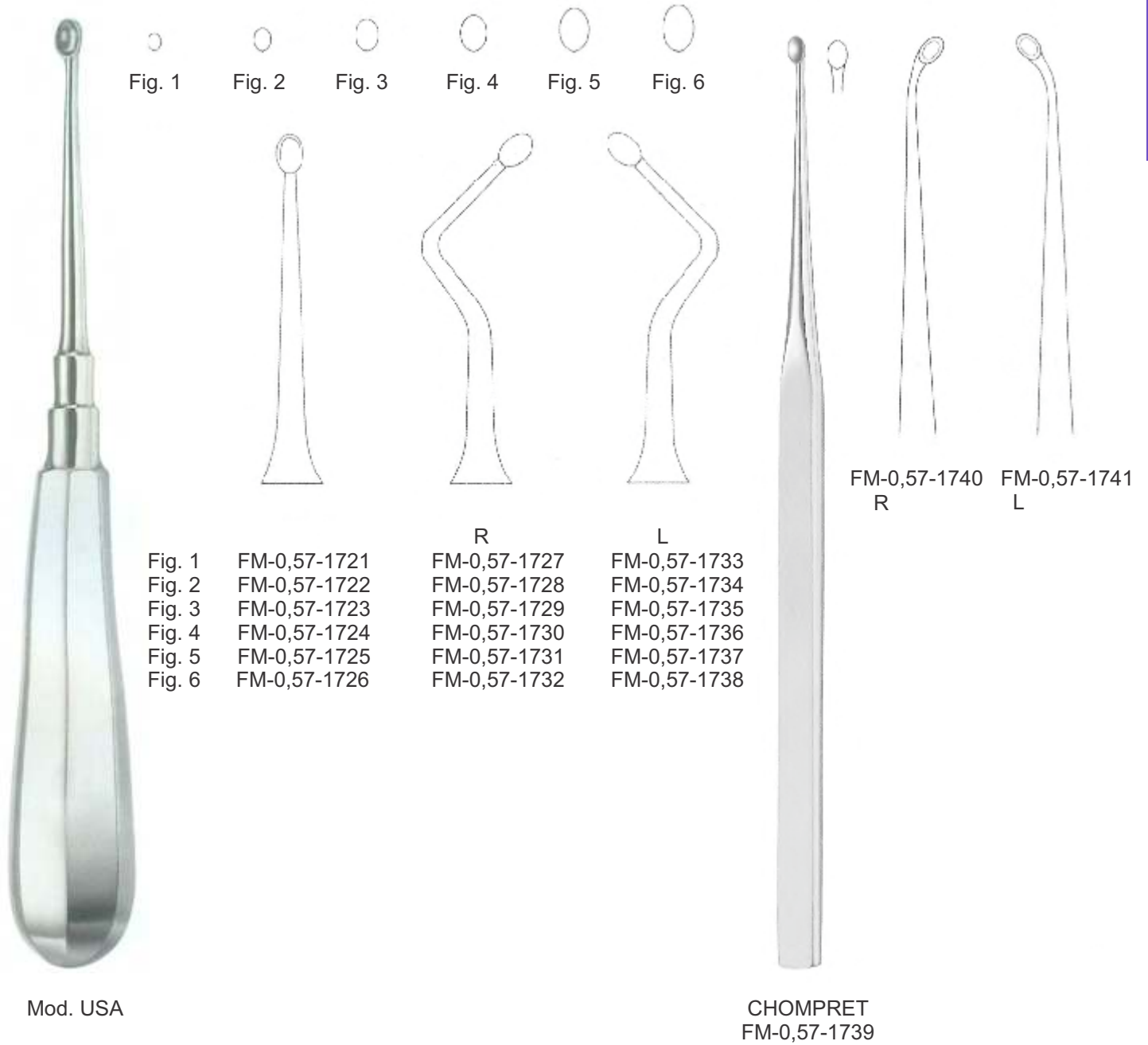

Fig. 1 Fig. 2 Fig. 3 Fig. 4 Fig. 5 Fig. 6

		R	L
Fig. 1	FM-0,57-1721	FM-0,57-1727	FM-0,57-1733
Fig. 2	FM-0,57-1722	FM-0,57-1728	FM-0,57-1734
Fig. 3	FM-0,57-1723	FM-0,57-1729	FM-0,57-1735
Fig. 4	FM-0,57-1724	FM-0,57-1730	FM-0,57-1736
Fig. 5	FM-0,57-1725	FM-0,57-1731	FM-0,57-1737
Fig. 6	FM-0,57-1726	FM-0,57-1732	FM-0,57-1738

FM-0,57-1740 FM-0,57-1741
 R L

Mod. USA

CHOMPRET
 FM-0,57-1739

EN	Bone Currettes
DE	Scharf Löffel
ES	Curettes á os
FR	Cucharillas cortantes
IT	Curette taglienti



BONE CURETTES

FM-0,57-1748-
FM-0,57-1749

FM-0,57-1750R-
FM-0,57-1751R



FM-0,57-1742
Fig. 00/00

FM-0,57-1743
Fig. 0/0

FM-0,57-1744
Fig. 1/1



FM-0,57-1745
Fig. 00/00

FM-0,57-1746
Fig. 0/0

FM-0,57-1747
Fig. 1/1



HEJMNGWAY
18 CM/7"



FM-0,57-1752
FM-0,57-1753
Fig. 1R / 1L

FM-0,57-1754
FM-0,57-1755
Fig. 2R / 2L

FM-0,57-1756
FM-0,57-1757
Fig. 3R / 3L

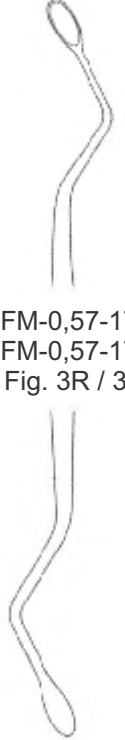
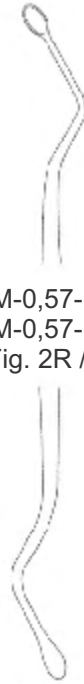
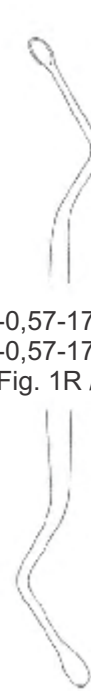

WILLGER

MARTINI

Bone Curettes **EN**

Scharf Löffel **DE**

Curettes á os **ES**

Cucharillas cortantes **FR**

Curette taglienti **IT**

57



BONE CURETTES



5,5 Ø9,5
mm mm
HEJMNGWAY
17 cm/6 ¾"

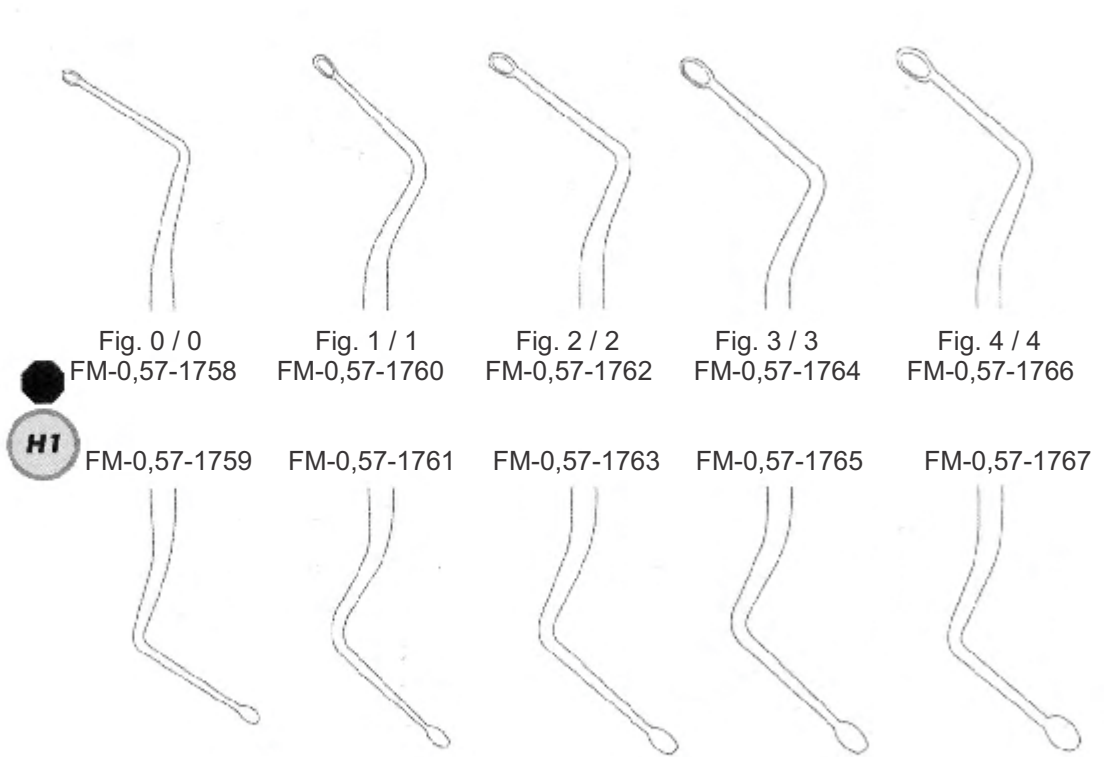

●	Fig. 0 / 0	Fig. 1 / 1	Fig. 2 / 2	Fig. 3 / 3	Fig. 4 / 4
	FM-0,57-1758	FM-0,57-1760	FM-0,57-1762	FM-0,57-1764	FM-0,57-1766
● H1	FM-0,57-1759	FM-0,57-1761	FM-0,57-1763	FM-0,57-1765	FM-0,57-1767

EN	Bone Currettes
DE	Scharf Löffel
ES	Curettes á os
FR	Cucharillas cortantes
IT	Curette taglienti



BONE CURETTES

FM-0,57-1768 FM-0,57-1770
 FM-0,57-1769 FM-0,57-1771

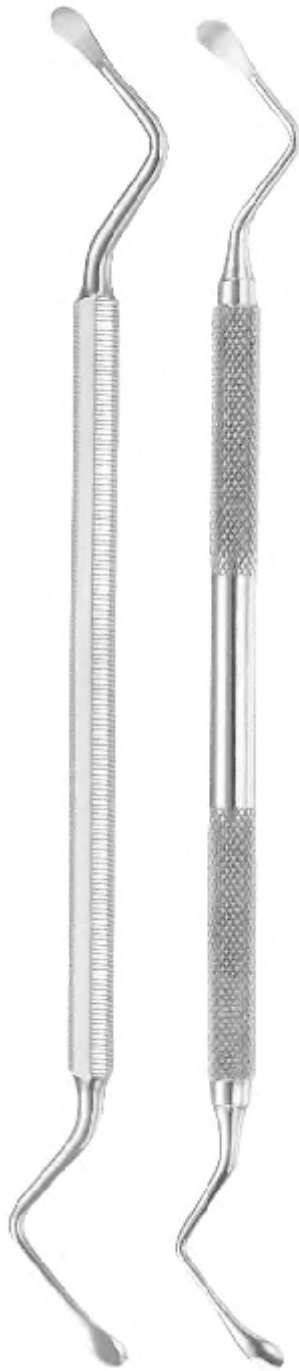

LUCAS
 17 cm/6¾"

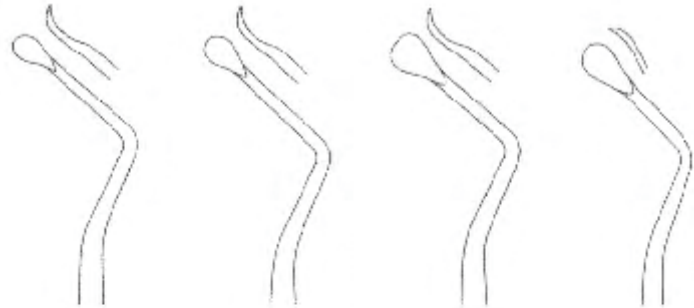

FM-0,57-1772 FM-0,57-1774 FM-0,57-1776 FM-0,57-1778
 FM-0,57-1773 FM-0,57-1775 FM-0,57-1777 FM-0,57-1779
 Fig. 1 / 1 Fig. 2 / 2 Fig. 3 / 3 Fig. 4 / 4



Bone Currettes **EN**
 Scharf Löffel **DE**
 Curettes á os **ES**
 Cucharillas cortantes **FR**
 Curette taglienti **IT**

57



BONE CURETTES



Fig. 4



MEAD
 FM-0,57-1780



Fig. 5



MEAD
 FM-0,57-1781



Fig. 1



FM-0,57-1782



Fig. 2



JMLLER-COLBURN
 FM-0,57-1783



Fig. 3



JMLLER-COLBURN
 FM-0,57-1784



Fig. 4



FM-0,57-1785

EN	Excavators
DE	Bagger
ES	Excavadoras
FR	Pelles
IT	escavatori

Page 85 to 89



EN	Excavators
DE	Exkavatoren
ES	Excavateurs
FR	Excavadores
IT	Escavatori



EXCAVATORS

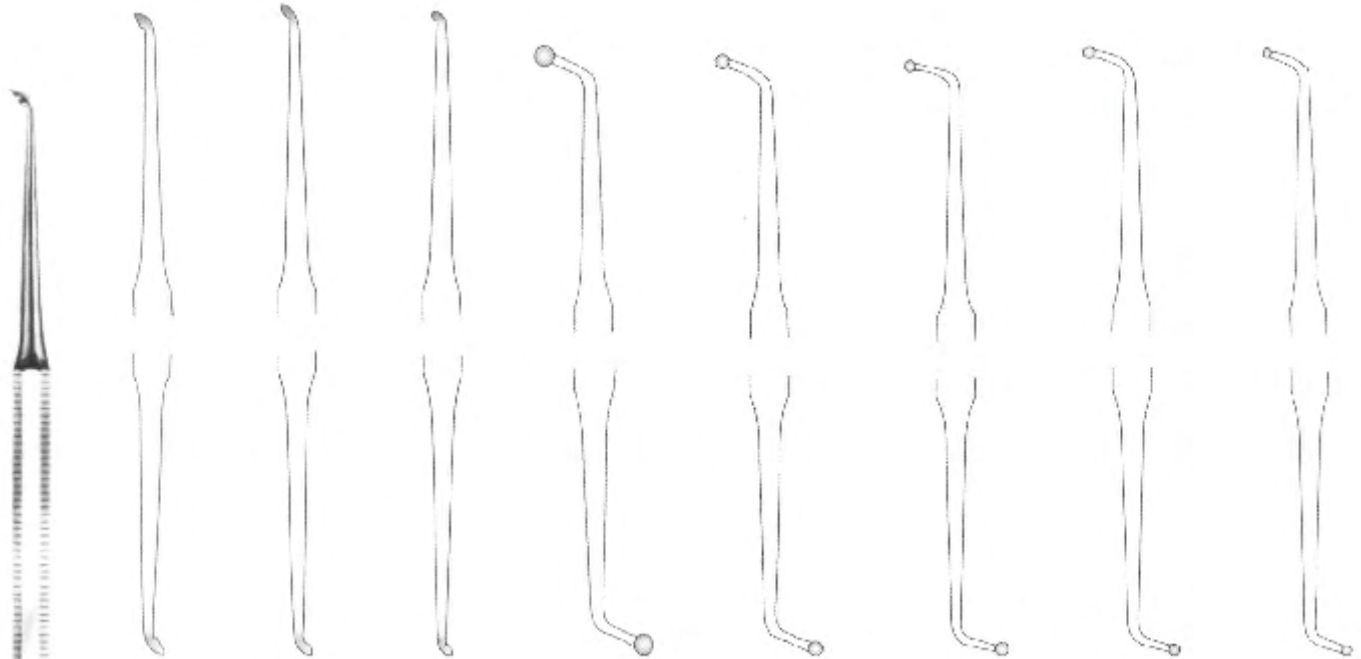

FM-0,58-1801 Fig. 73/74 FM-0,58-1802 Fig. 74/111 FM-0,58-1803 Fig. 111/112 FM-0,58-1804 Fig. 113/114 FM-0,58-1805 Fig. 115/116 FM-0,58-1806 Fig. 117/118 FM-0,58-1807 Fig. 119/120

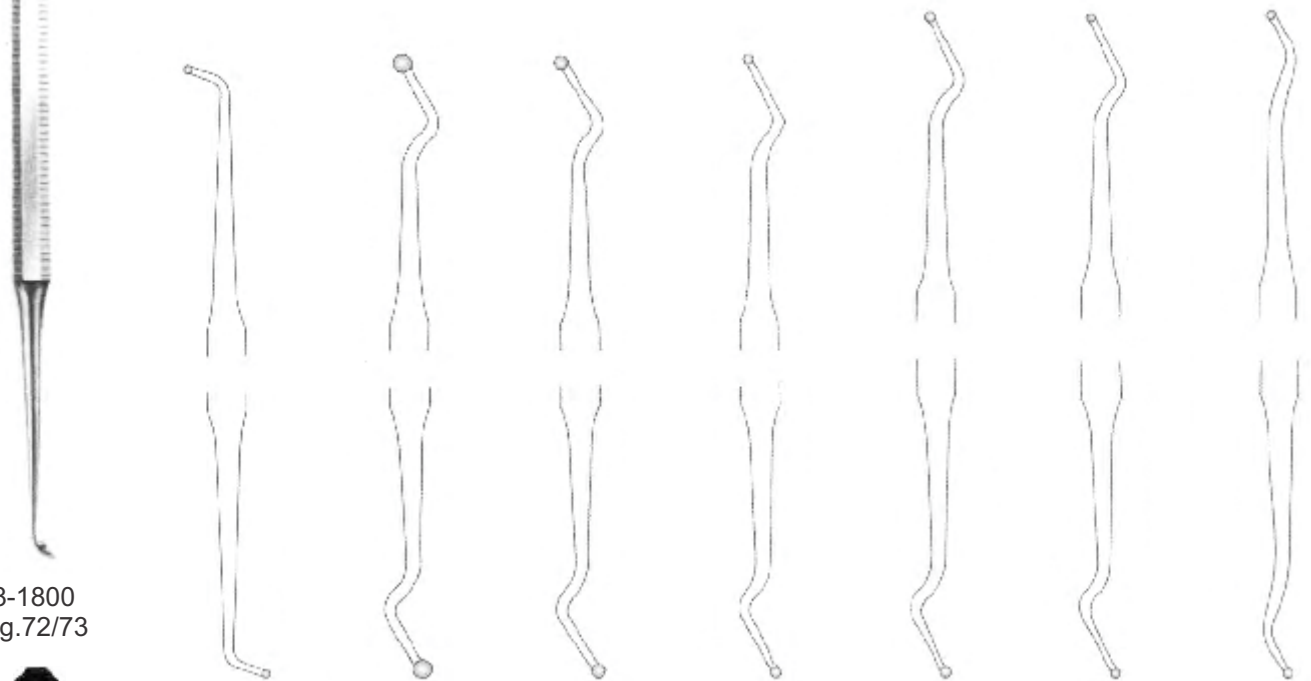

58-1800 Fig.72/73



5.5 mm FM-0,58-1809 Fig.123/124 FM-0,58-1810 Fig.125/126 FM-0,58-1811 Fig.127/128 FM-0,58-1812 Fig.129/130 FM-0,58-1813 Fig.131/132 FM-0,58-1814 Fig.133/134 FM-0,58-1815 Fig.155/156



FM-0,58-1816
Fig.139/140



FM-0,58-1817
Fig.141/142



FM-0,58-1818
Fig.159/160



FM-0,58-1819
Fig.161/162



FM-0,58-1820
Fig.165/166



FM-0,58-1821
Fig.171/172

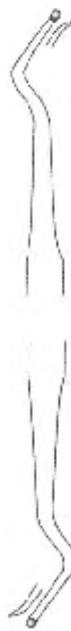

FM-0,58-1822
Fig.173/174



FM-0,58-1823
Fig.175/176



FM-0,58-1824
Fig.177/178



FM-0,58-1825
Fig.179/180

EN	Excavators
DE	Exkavatoren
ES	Excavateurs
FR	Excavadores
IT	Escavatori



EXCAVATORS

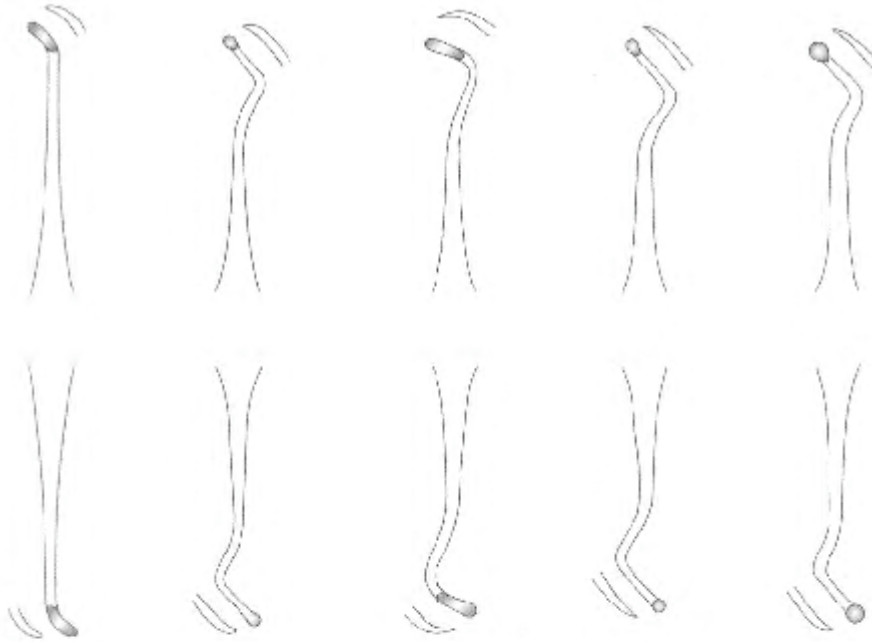

FM-0,58-1826 Fig. 5
 FM-0,58-1827 Fig. 13
 WHITE FM-0,58-1828 Fig. 14
 FM-0,58-1829 Fig. 15
 FM-0,58-1830 Fig. 17

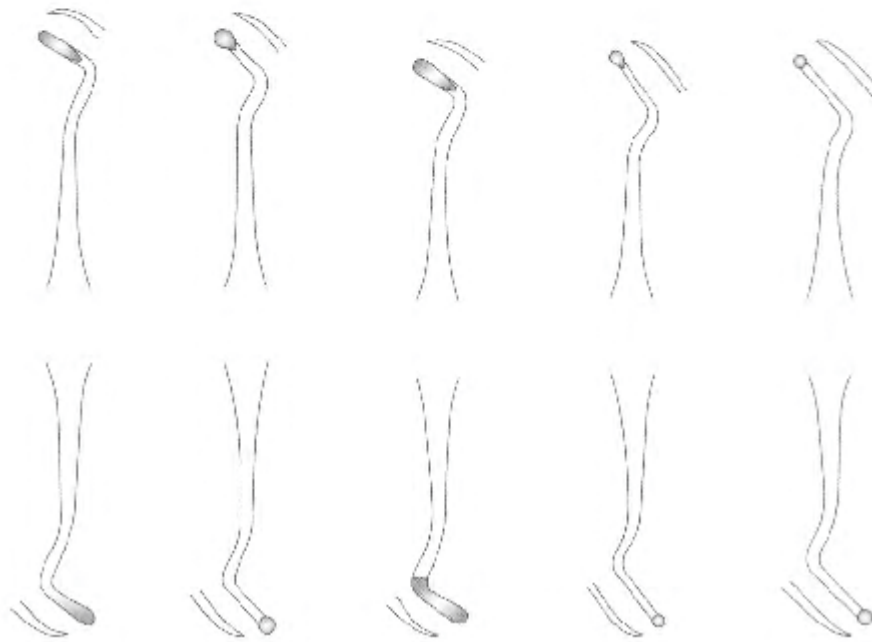

FM-0,58-1831 Fig. 18
 FM-0,58-1832 Fig. 19
 WHITE FM-0,58-1833 Fig. 20
 FM-0,58-1834 Fig. 23
 FM-0,58-1835 Fig. 25

Excavators **EN**
 Exkavatoren **DE**
 Excavateurs **ES**
 Excavadores **FR**
 Escavatori **IT**

58



EXCAVATORS



Ø6 mm
 H1 Ø9,5 mm

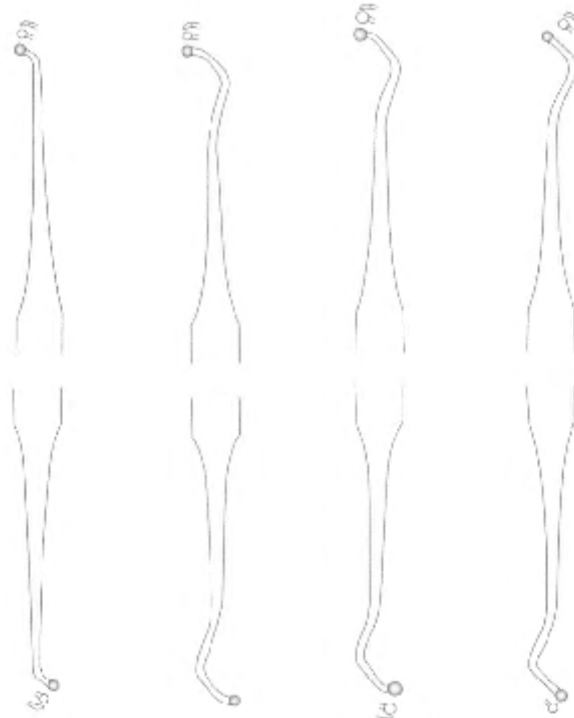

Fig. 5 FM-0,58-1836
 Fig. 13 FM-0,58-1837
 Fig. 14 FM-58-1838
 Fig. 17 FM-58-1839
 H1 FM-58- 40 FM-58- 41 FM-58- 42 FM-58- 43

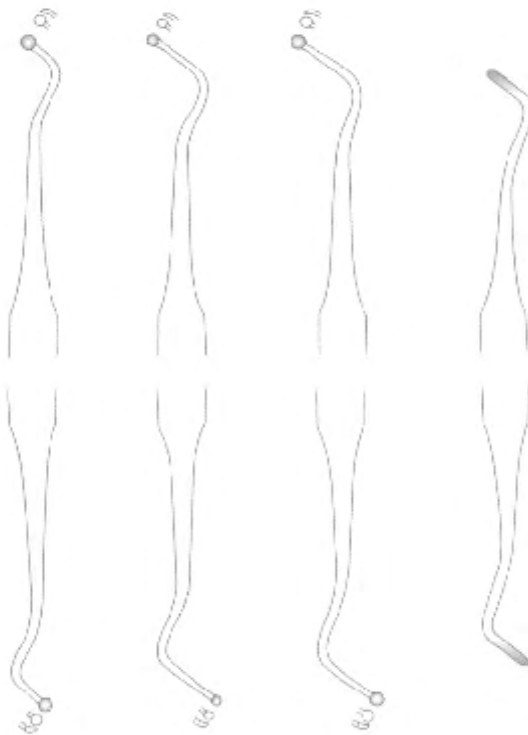

Fig.18 FM-58- 44
 Fig. 31 FM-58- 45
 Fig. 33 FM-58- 46
 Fig. 35 FM-58- 47
 H1 FM-58- 48 FM-58- 49 FM-58- 50 FM-58- 51

EN	Excavators
DE	Exkavatoren
ES	Excavateurs
FR	Excavadores
IT	Escavatori



EXCAVATORS



FM-58-52
Fig. 5/6

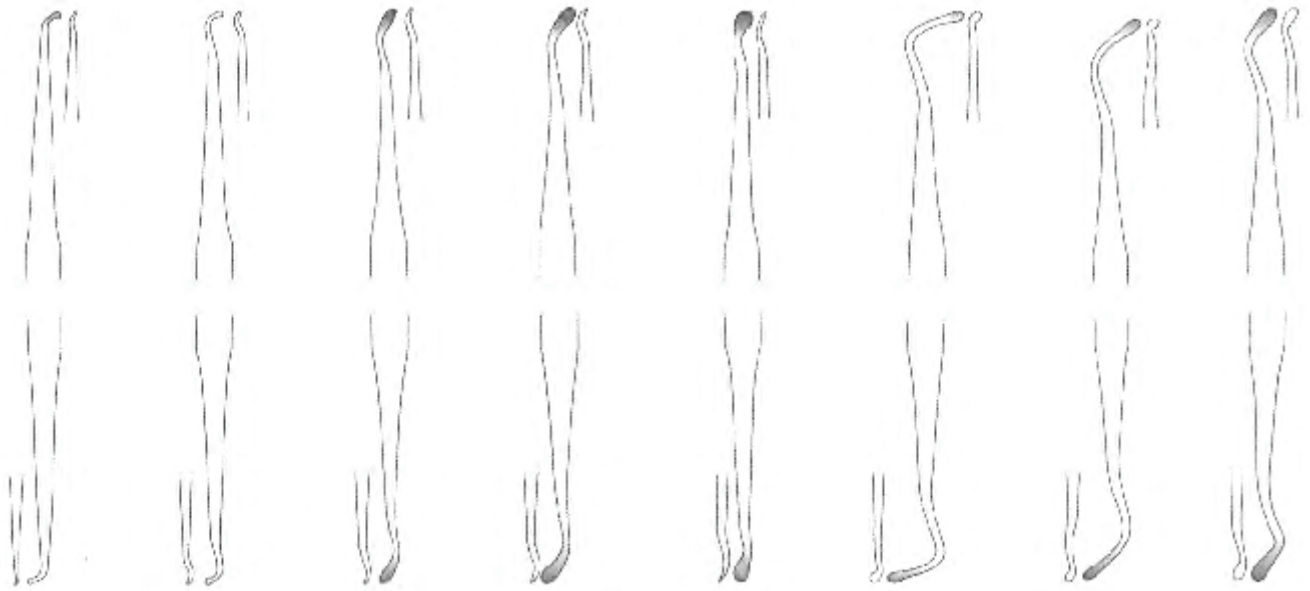

DARBY-PERRY

FM-58- 53 Fig. 7/8 FM-58- 54 Fig. 9/10 FM-58- 55 Fig. 11/12 FM-58- 56 Fig. 13/14 FM-58- 57 Fig. 15/16 FM-58- 58 Fig. 17/18 FM-58- 59 Fig. 19/20 FM-58- 60 Fig. 21/22

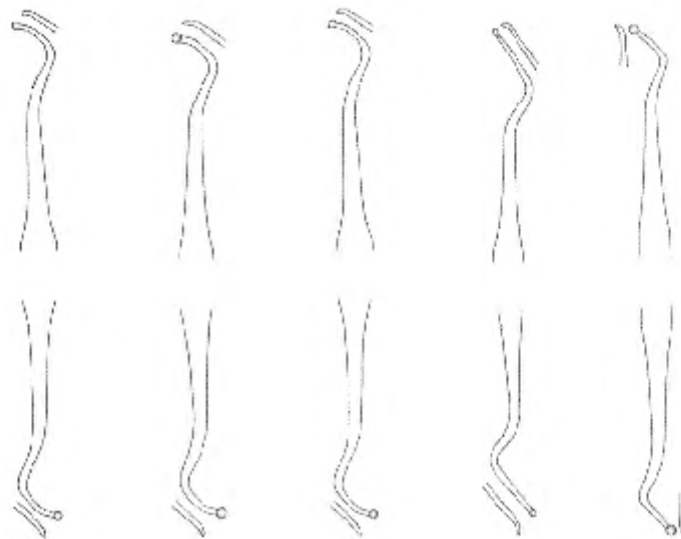

GILLET

FM-58- 61 Fig. 4/5 FM-58- 62 Fig. 6/7 FM-58- 63 Fig. 7/8 FM-58- 64 Fig. 12/13 FM-58- 65 Fig. 14/15

EN	Wax Proclein
DE	Wachs-Porzellan
ES	cera Porcelana
FR	Cire Porcelaine
IT	Cera porcellana

Page 90 to 94



EN Wax, porcelain and modelling carvers
 DE Wachs-, Porzellan- und Modellierinstrumente
 ES Instrumentos A modeler
 FR Talladores y espátulas para cera, porcelana y modelar
 IT Strumenti per modellare



MODELLING CARVERS



5,5 mm

H1
 Ø9,5 mm



FM-59-1901
 Fig. 1

FM-59-1902
 Fig. 2

FM-59-1903
 Fig. 3

FM-59-1904
 Fig. 4

FM-59-1905
 Fig. 5



FM-59-1906H

FM-59-1907H

FM-59-1908H

FM-59-1909H

FM-59-1910H

Aluminium

RS-59-1911

RS-59-1912

RS-59-1913

RS-59-1914

RS-59-1915

gold

green

blue

red

silver

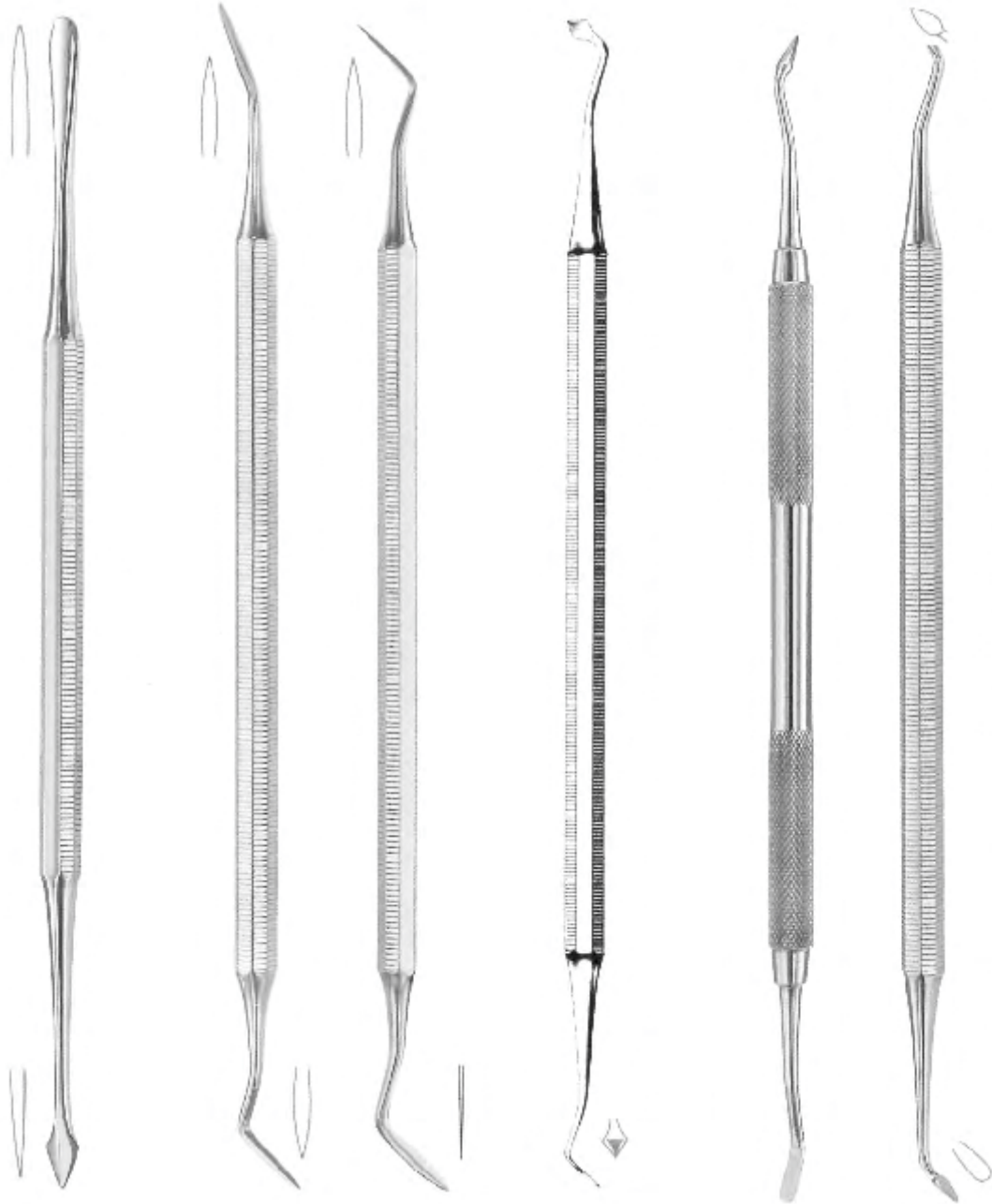

GRITMAN
FM-59-1916

WARD
FM-59-1917 Fig. 1
FM-59-1918 Fig. 2

FRAHM
FM-59-1919

SHOSHAN
FM-59-1920
SHO-A

W.A.C.D
FM-59-1921

EN	Wax, porcelain and modelling carvers
DE	Wachs-, Porzellan- und Modellierinstrumente
ES	Instrumentos A modeler
FR	Talladores y espátulas para cera, porcelana y modelar
IT	Strumenti per modellare

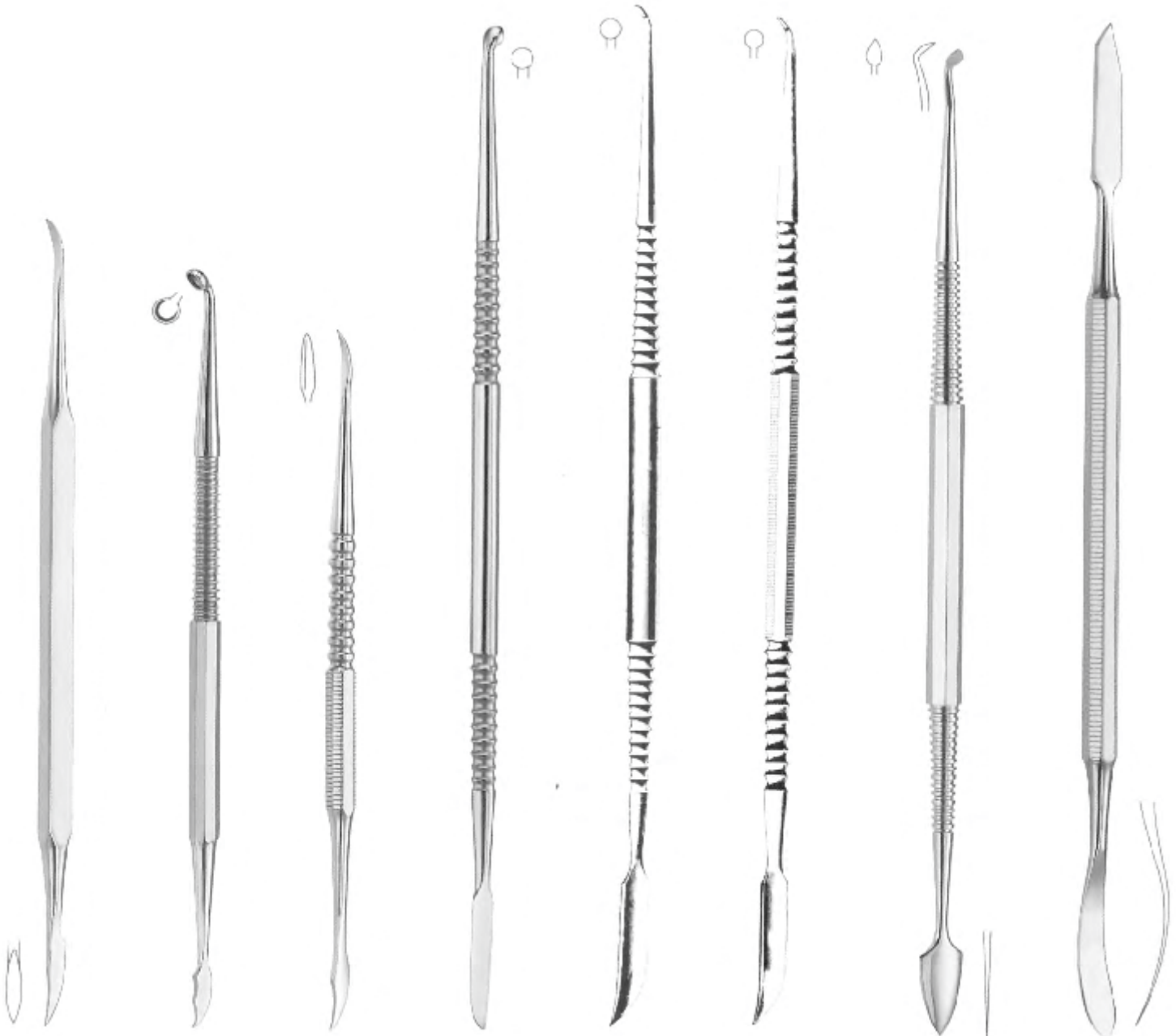

HYLIN
FM-59-1922

ZAHLE
FM-59-1923 FM-59-1924

FM-59-1925

LE CRON
FM-59-1926

FM-59-1927

VEHE
FM-59-1928

FIELDSTAD
FM-59-1929



ROACH
FM-59-1930 FM-59-1931

RIEGNER
FM-59-1932

FM-59-1933
Fig. 1

FM-59-1934
Fig. 2

FRAHM
FM-59-1935
Fig. 6

FM-59-1936
Fig. 10

FM--59-1937
Fig. 6/10

EN	Wax, porcelain and modelling carvers
DE	Wachs-, Porzellan- und Modellierinstrumente
ES	Instrumentos A modeler
FR	Talladores y espátulas para cera, porcelana y modelar
IT	Strumenti per modellare



EN	Filling Instruments
DE	Füllungsinstrumente
ES	Actos de llenado
FR	Instruments de remplissage
IT	Strumenti di riempimento

Page 95 to 105



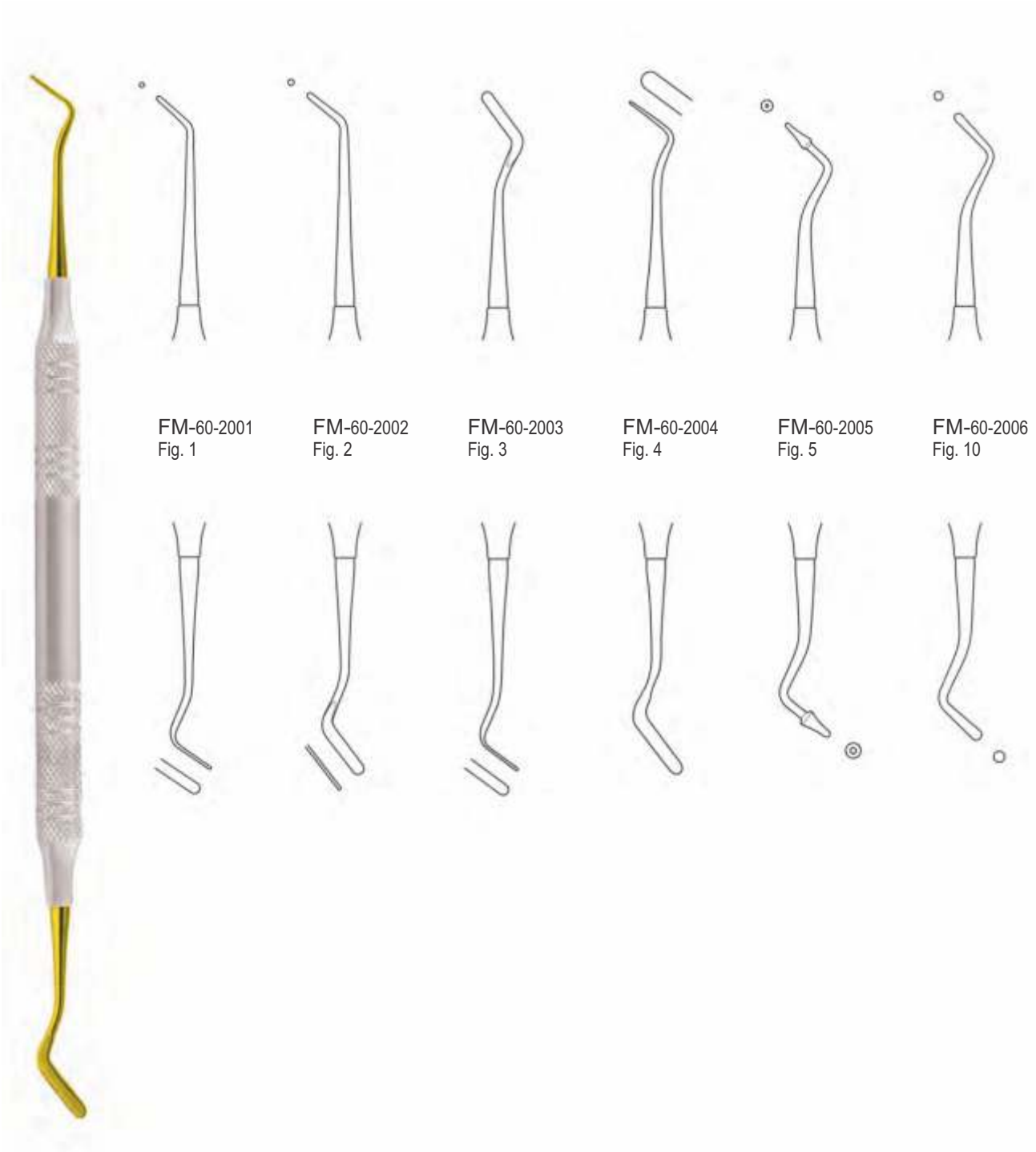

FM-60-2001
 Fig. 1

FM-60-2002
 Fig. 2

FM-60-2003
 Fig. 3

FM-60-2004
 Fig. 4

FM-60-2005
 Fig. 5

FM-60-2006
 Fig. 10





FM-60-2007
Fig. 1
Felt



FM-60-2008
Fig. 2
Felt



FM-60-2009
Fig. 3
Felt



FM-60-2010
Fig. 4
Felt



FM-60-2011
Fig. 5
Felt



FM-60-2012
Fig. 6
Felt



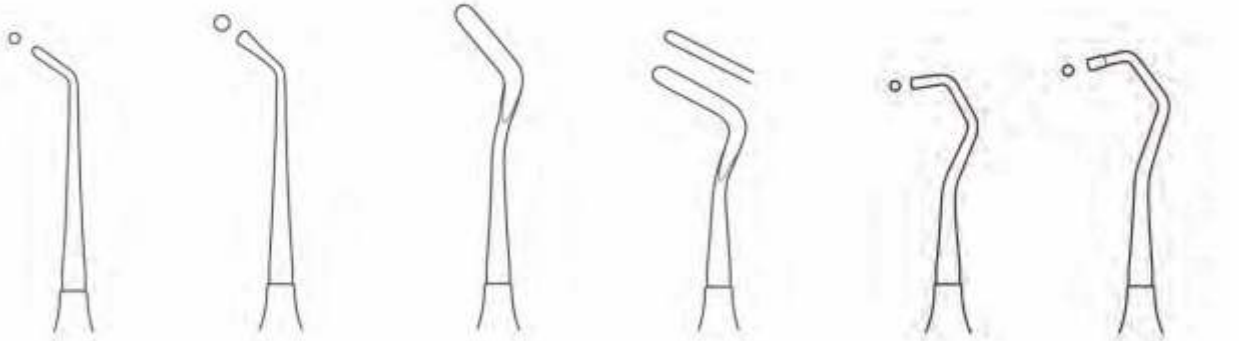

JM-60-2013
 Fig. 1
 Goldstein

FM-60-2014
 Fig. 2
 Goldstein

FM-60-2015
 Fig. 3
 Goldstein

FM-60-2016
 Fig. 4
 Goldstein

FM-60-2017
 Fig. 9/10

FM-60-2018
 Fig. 11/12





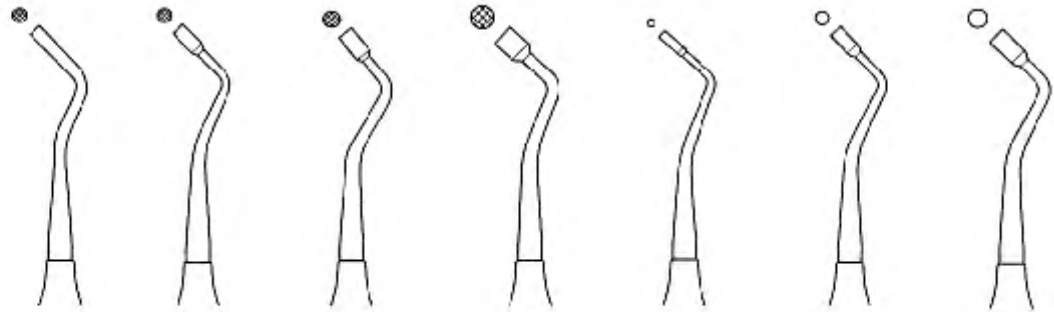

FM-60-2026 Fig. 1S	FM-60-2027 Fig. 2S	FM-60-2028 Fig. 3S	FM-60-2029 Fig. 4S	FM-60-2030 Fig. 1P	FM-60-2031 Fig. 2P	FM-60-2032 Fig. 3P
-----------------------	-----------------------	-----------------------	-----------------------	-----------------------	-----------------------	-----------------------

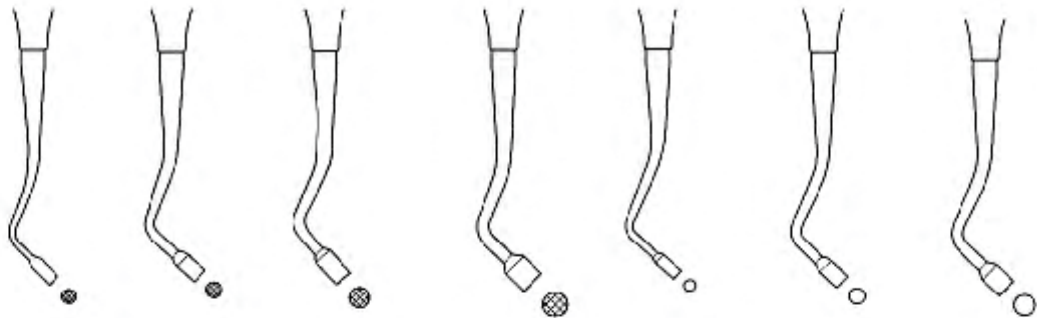



FAIZAN & MUSA
SURGICAL

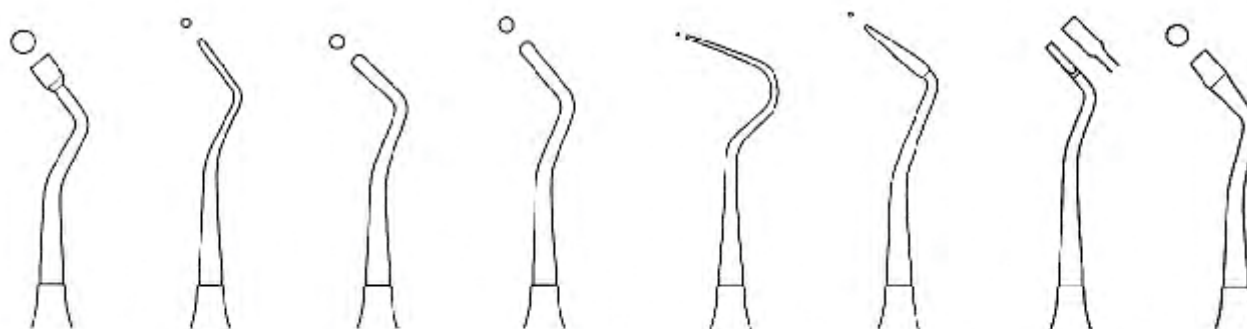

FM-60-2033 Fig. 4P FM-60-2034 Fig. 1D FM-60-2035 Fig. 2D FM-60-2036 Fig. 3D FM-60-2037 Fig. M1 Markley FM-60-2038 Fig. M2 FM-60-2039 Fig. M3 FM-60-2040 Fig. M4

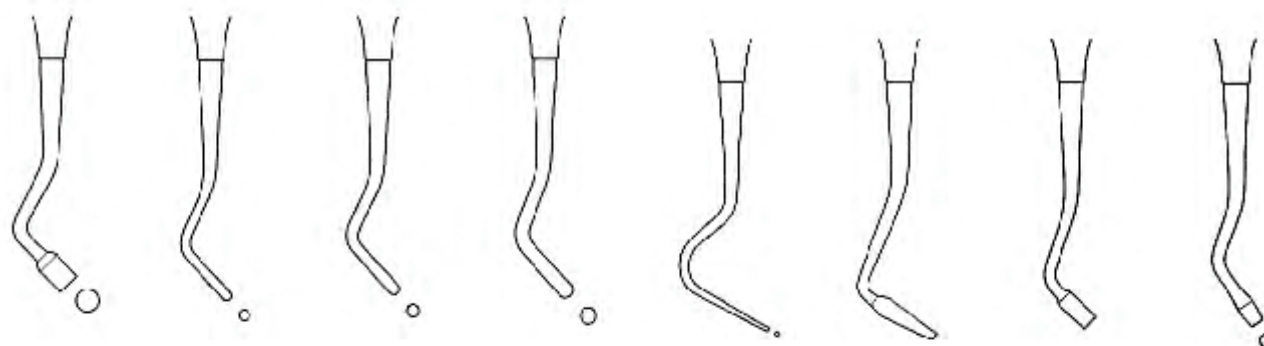

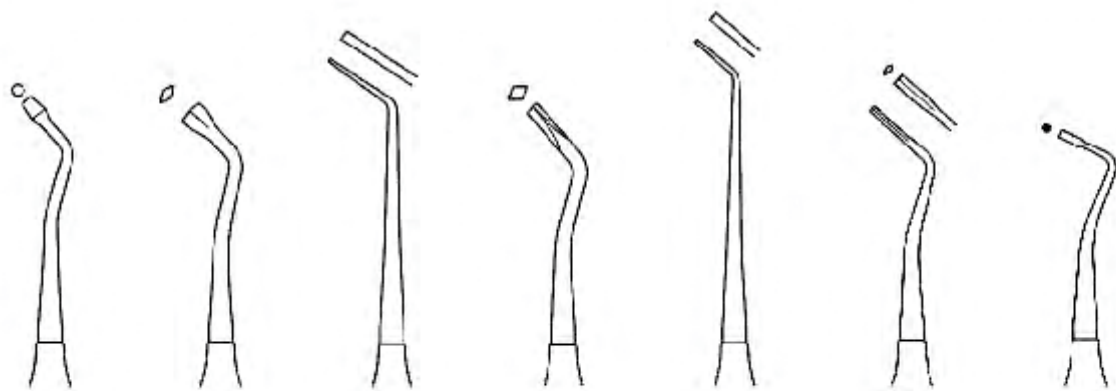

FM-60-2041 Fig. M5
 FM-60-2042 Fig. M6
 FM-60-2043 Fig. H1 Hollenback
 FM-60-2044 Fig. H2 Hollenback
 FM-60-2045 Fig. H3 Hollenback
 FM-60-2046 Fig. H4 Hollenback
 FM-60-2047 Fig. MQ 1S

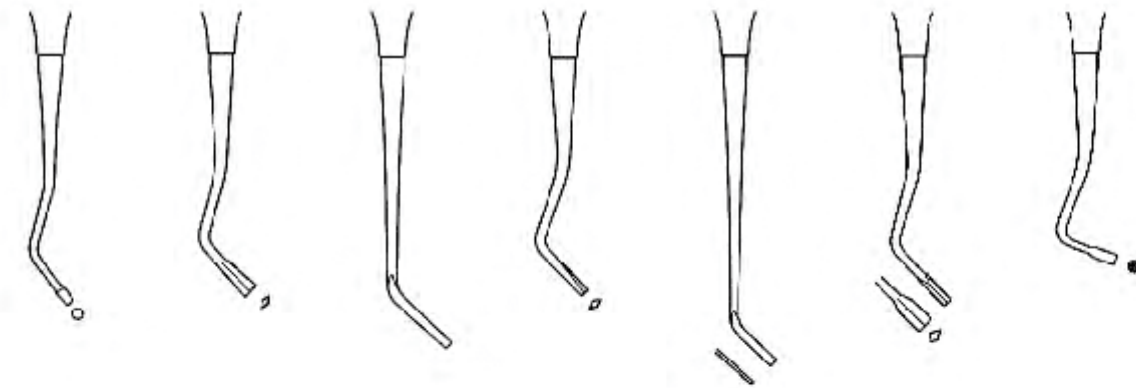

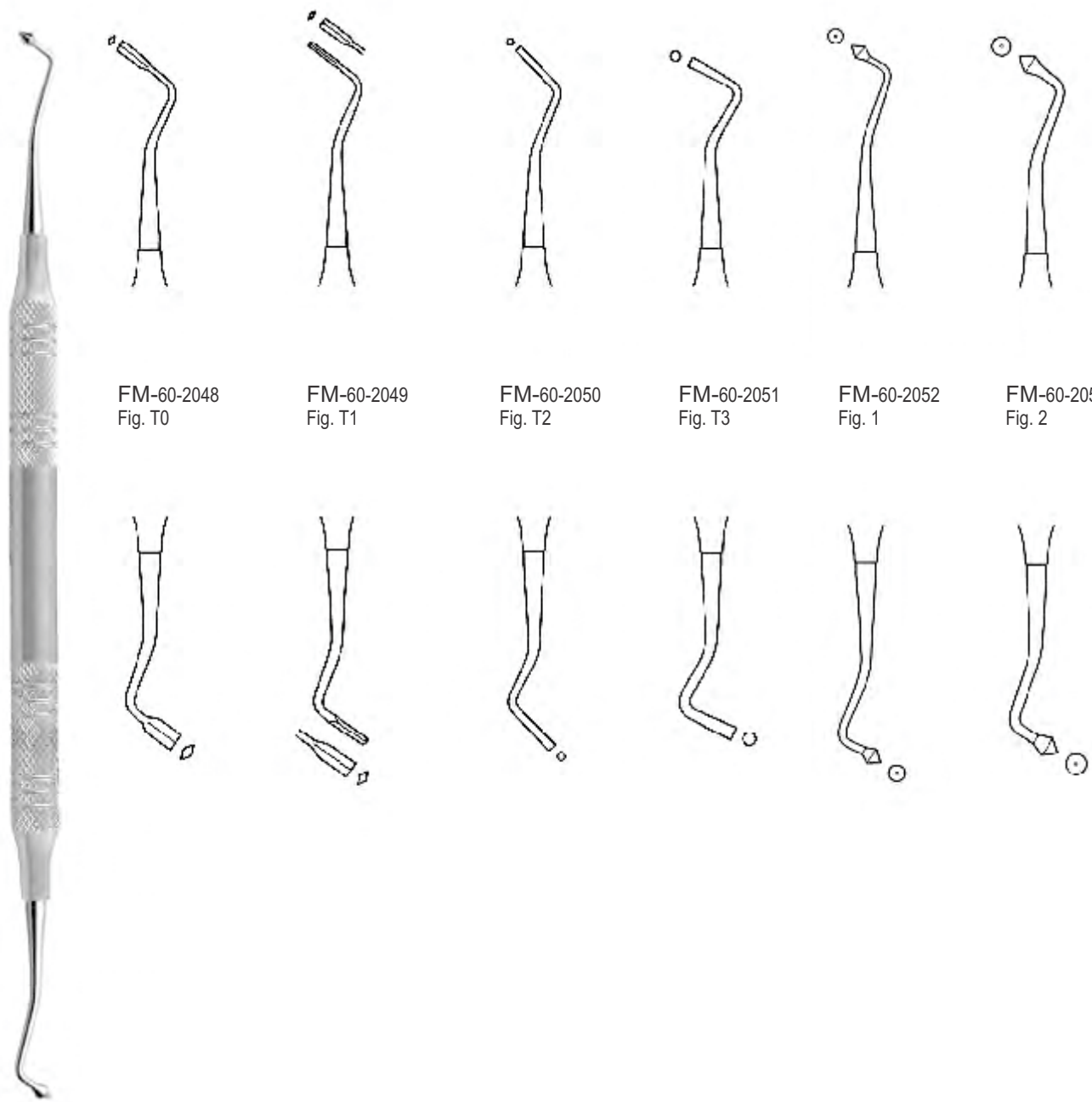

FM-60-2048
Fig. T0

FM-60-2049
Fig. T1

FM-60-2050
Fig. T2

FM-60-2051
Fig. T3

FM-60-2052
Fig. 1

FM-60-2053
Fig. 2

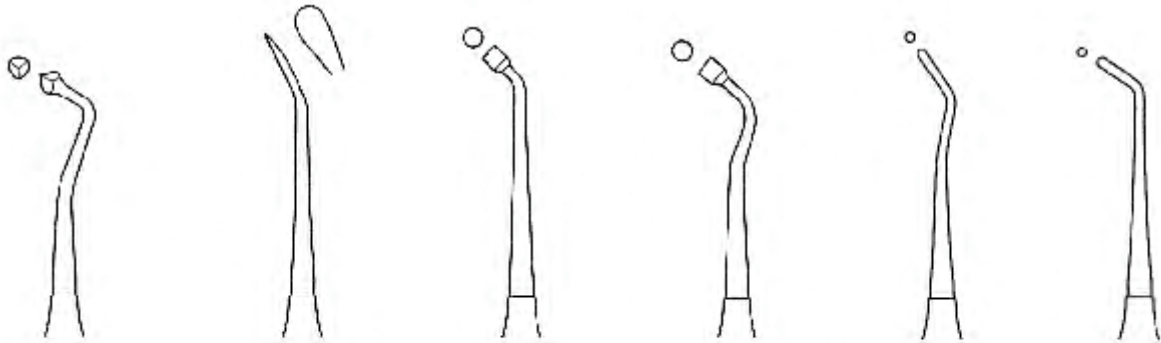

FM-60-2054
 Fig. 3

FM-60-2055
 Fig. WO 1
 Woodson

FM-60-2056
 Fig. WO 2
 Woodson

FM-60-2057
 Fig. WO 3
 Woodson

FM-60-2058
 Fig. L2
 Ladmore

FM-60-2059
 Fig. L3
 Ladmore

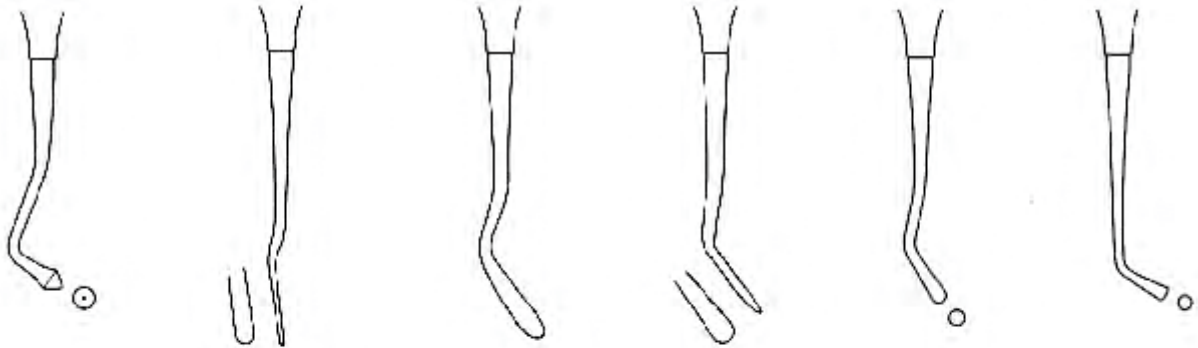

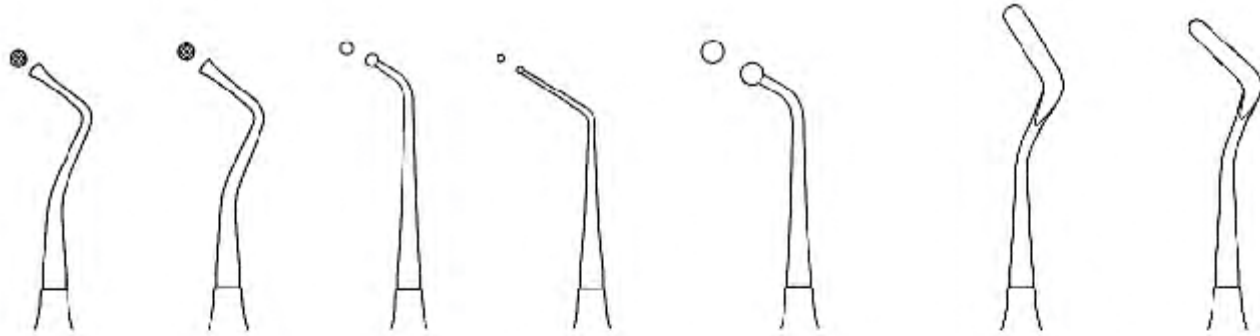

FM-60-2060 Fig. 1 Ward	FM-60-2061 Fig. 2 Ward	FM-60-2062 Fig. 7A	FM-60-2063 Fig. 19	FM-60-2064 Fig. 7B	FM-60-2065 Fig. 6	FM-60-2066 Fig. 11
------------------------------	------------------------------	-----------------------	-----------------------	-----------------------	----------------------	-----------------------

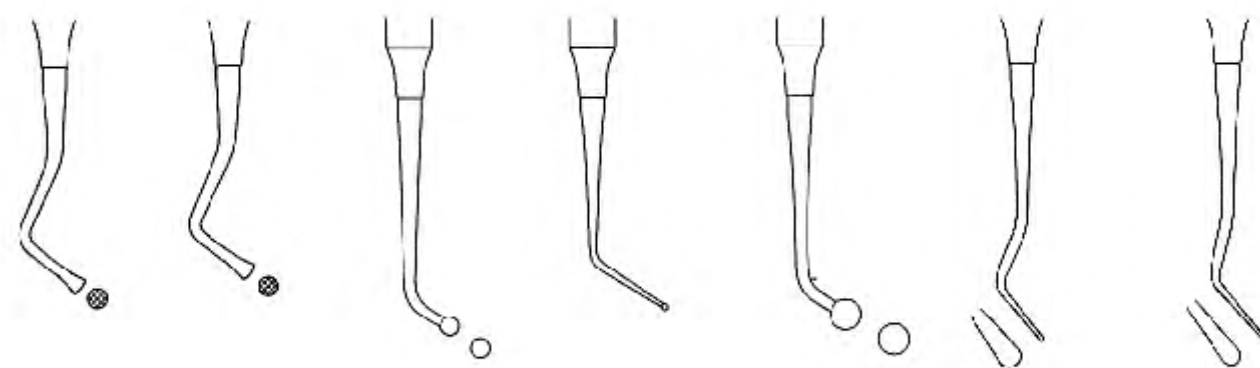

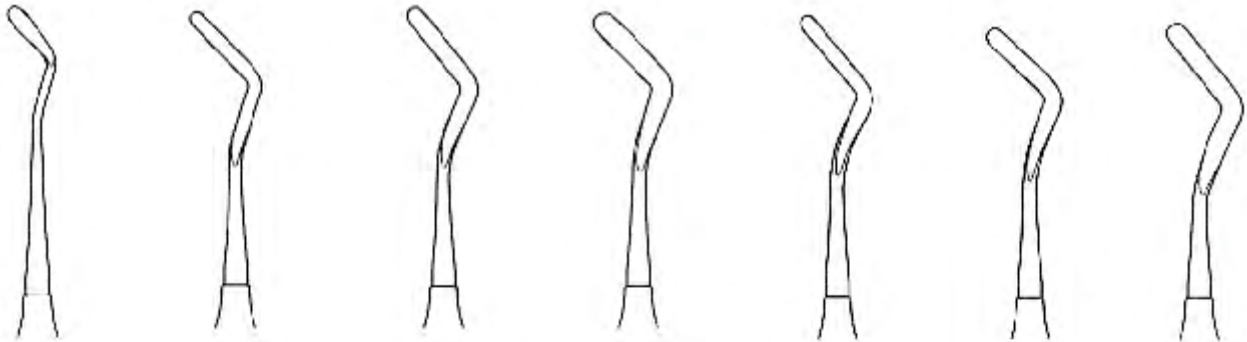

FM-60-2067
Fig. 179

FM-60-2068
Fig. 1
2 mm

FM-60-2069
Fig. 2
2.5 mm

FM-60-2070
Fig. 3
3 mm

FM-60-2071
Fig. 11

FM-60-2072
Fig. 12

FM-60-2073
Fig. 13

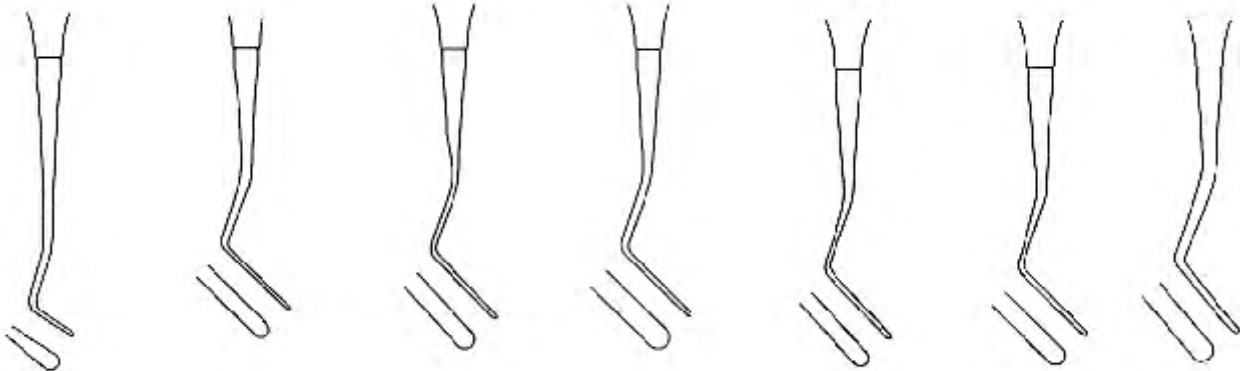

EN	Gingivectomy Knives
DE	Gingivektomie Messer
ES	Cuchillos de gingivectomía
FR	Couteaux de gingivectomie
IT	Coltelli per gengivectomia

Page 106 to 107



EN	Periodontal Knives
DE	Parodontale Messer
ES	Cuchillos periodontales
FR	Couteaux parodontaux
IT	Coltelli periodontali



GINGIVECTOMY KNIVES

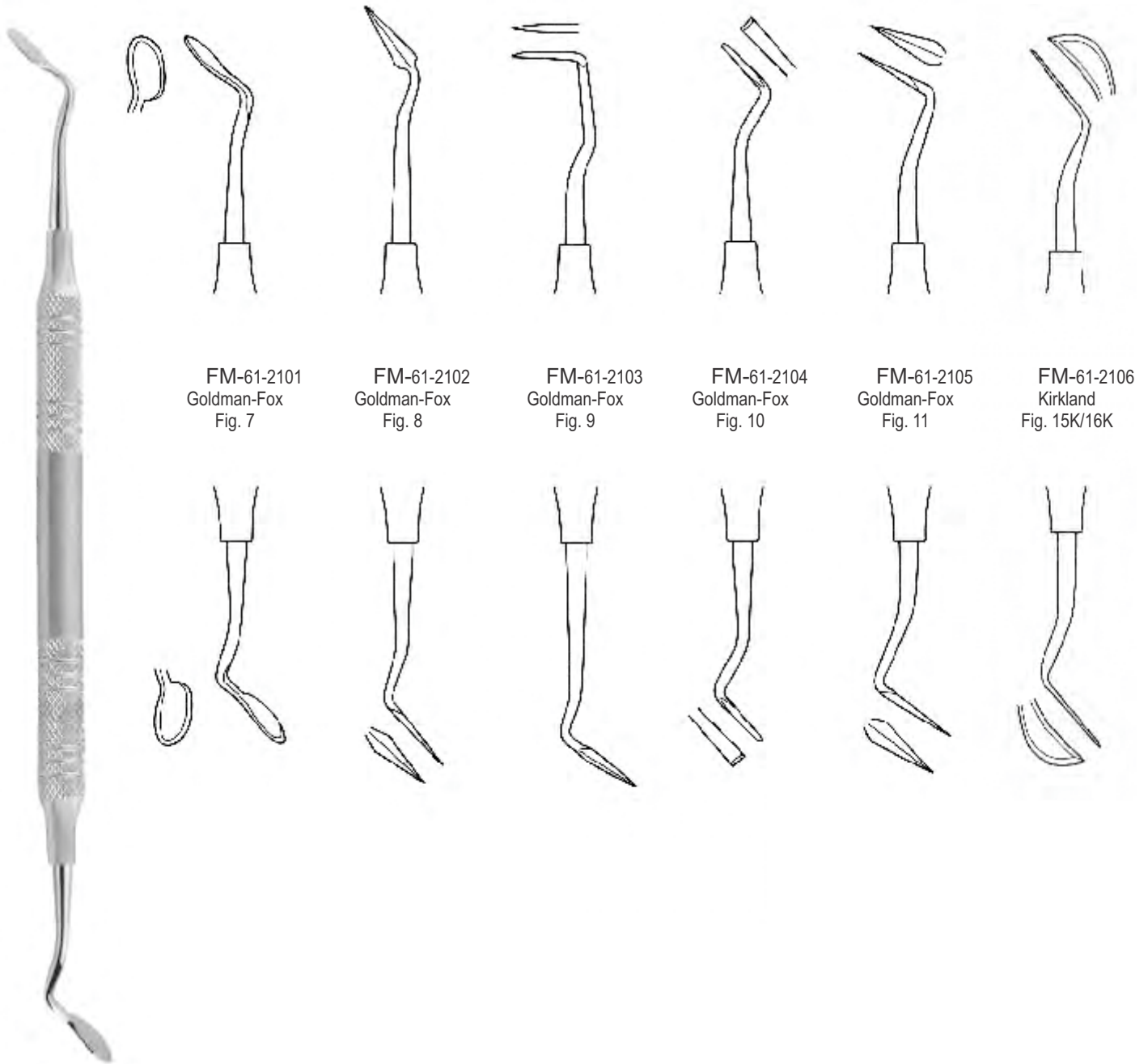

FM-61-2101
Goldman-Fox
Fig. 7

FM-61-2102
Goldman-Fox
Fig. 8

FM-61-2103
Goldman-Fox
Fig. 9

FM-61-2104
Goldman-Fox
Fig. 10

FM-61-2105
Goldman-Fox
Fig. 11

FM-61-2106
Kirkland
Fig. 15K/16K

Periodontal Knives	EN
Parodontale Messer	DE
Cuchillos periodontales	ES
Couteaux parodontaux	FR
Coltelli periodontali	IT

61

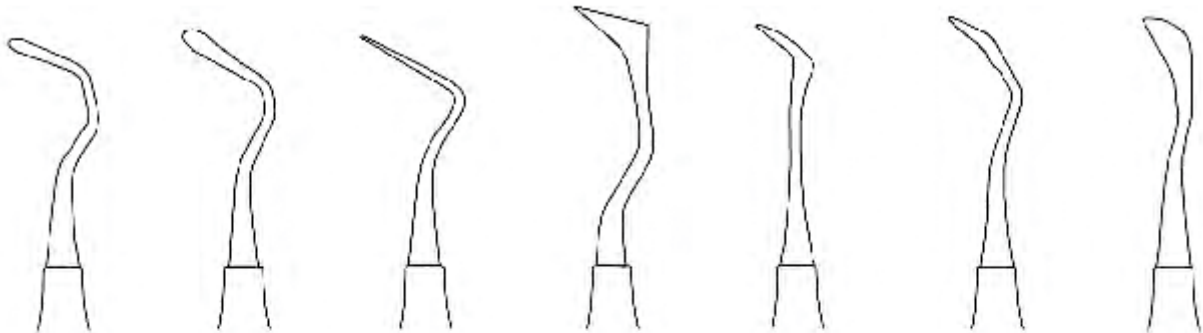

FM-61-2107
Fig. 1
Reddy Thin

FM-61-2108
Fig. 2
Reddy Thin

FM-61-2109
Fig. 1/2
Sanders

FM-61-2110
Fig. 19/20
USC Towner

FM-61-2111
Fig. CK-3
Crane Kaplan

FM-61-2112
Fig. CK-6
Crane Kaplan

FM-61-2113
Fig. 1/2
Solt

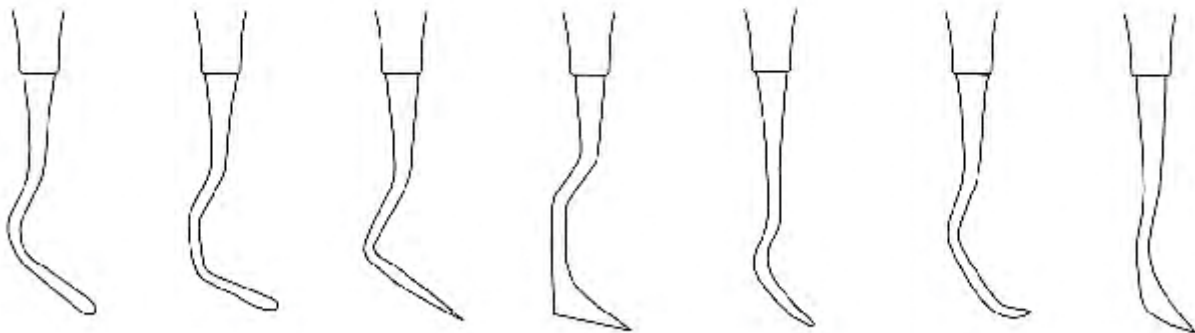

EN	Cement Spatulas
DE	Zementspatel
ES	Espátulas de cemento
FR	Spatules de ciment
IT	Spatole di cemento

Page 108 to 112



EN Cement Spatulas

DE Zementspatel

ES Espátulas de cemento

FR Spatules de ciment

IT Spatole di cemento



FM-62-2151
Fig. 26
Distal

FM-62-2152
Fig. 27
Mesial

FM-62-2153
Fig. 29
Mesial

FM-62-2154
Fig. 29
Mesial

FM-62-2155
Fig. 77/78
Distal

FM-62-2156
Mesial
54-1142-00

FM-62-2157
Fig. 28
Distal

Cement Spatulas EN

Zementspatel DE

Espátulas de cemento ES

Spatules de ciment FR

Spatole di cemento IT

62



Wooden Handle

CEMENT SPATULAS



FM-62-2158
Fig. 28
Distal



FM-62-2159
Fig. 28
Distal



FM-62-2160
Fig. 28
Distal



FM-62-2161
Fig. 28
Distal



FM-62-2162
Fig. 28
Distal

EN	Cement Spatulas
DE	Zementspatel
ES	Espátulas de cemento
FR	Spatules de ciment
IT	Spatole di cemento



FM-0,62-2163
Fig. 1



Fig. 2



Fig. 3



Fig. 4



Fig. 5



Fig. 1



Fig. 2
FM-0,62-2164



Fig. 3

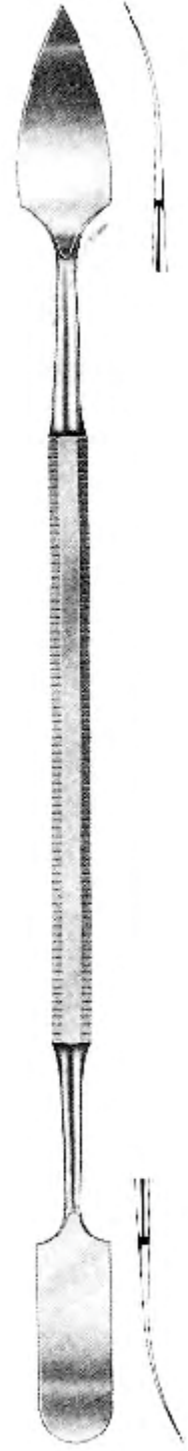

FM-0,62-2165
Fig. 31
Gritman

Cement Spatulas EN

Zementspatel DE

Espátulas de cemento ES

Spatules de ciment FR

Spatole di cemento IT

62



CEMENT SPATULAS



FM-0,62-2166
Fig. 1



Fig. 2



Fig. 3



FM-0,62-2167
Fig. 1

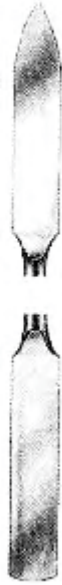

Fig. 2



Fig. 5



Fig. 3



Fig. 6



Fig. 4



Fig. 7

EN	Cement Spatulas
DE	Zementspatel
ES	Espátulas de cemento
FR	Spatules de ciment
IT	Spatole di cemento

CEMENT SPATULAS



FM-0,62-2168
Fig. 1



Fig. 2



Fig. 4



Fig. 5



Fig. 322



Fig. 324



Fig. 6



Fig. 7



Fig. 8



FM-0,62-2169
Fig. 313



Fig. 5



Fig. 8



FM-0,62-2170



Fig. 24 A



Fig. 25 E



Fig. 11



Fig. 12

EN	Mouth Mirrors
DE	Mundspiegel
ES	Espejos bucales
FR	Bouche Miroirs
IT	Bocca specchi

Page 113 to 115

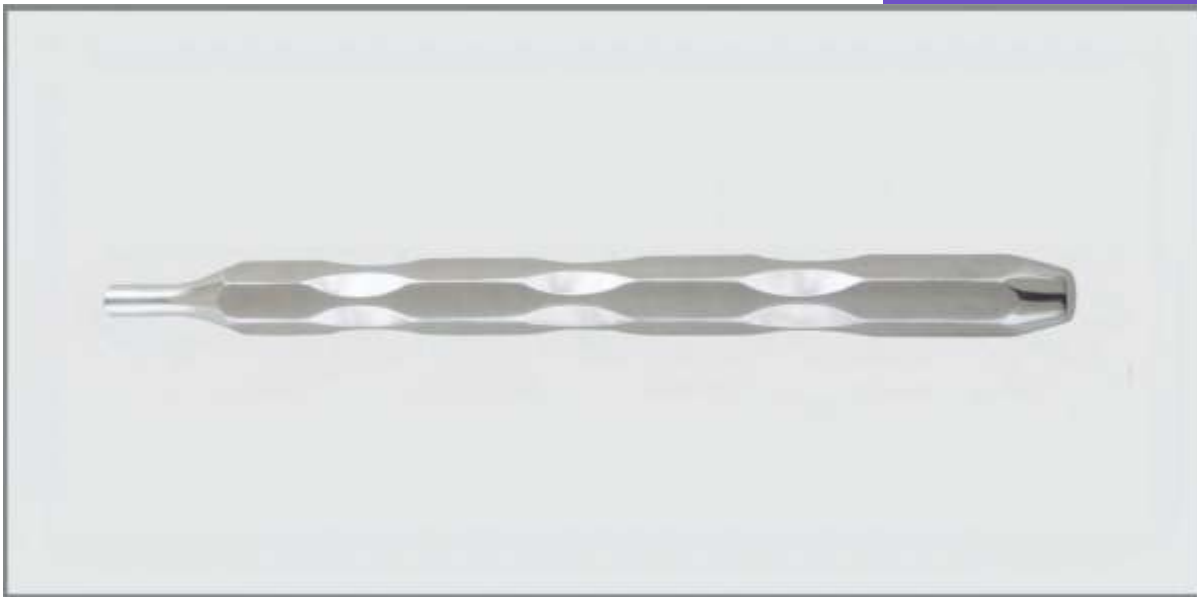

EN	Mouth Mirrors
DE	Mundspiegel
ES	Miroirs á boca
FR	Espejos de boca
IT	Specchietti



Simple Stem



Plain
Magnifying
Front Surface

- | | |
|-----------|-----------------|
| 1 = 16 mm | FM-0,63-2301-16 |
| 3 = 20 mm | FM-0,63-2301-20 |
| 4 = 22 mm | FM-0,63-2301-22 |
| 5 = 24 mm | FM-0,63-2301-24 |



Plain
Magnifying
Front Surface

- | | |
|-----------|-----------------|
| 4 = 22 mm | FM-0,63-2302-22 |
| 5 = 24 mm | FM-0,63-2302-24 |



Plain
Magnifying
Front Surface

- | | |
|-----------|-----------------|
| 3 = 20 mm | FM-0,63-2303-20 |
| 4 = 22 mm | FM-0,63-2303-22 |
| 5 = 24 mm | FM-63-2303-24 |

Cone Socket



Plain
Magnifying
Front Surface

- | | |
|-----------|---------------|
| 3 = 20 mm | FM-63-2304-20 |
| 4 = 22 mm | FM-63-2304-22 |
| 5 = 24 mm | FM-63-2304-24 |



Plain
Magnifying
Front Surface

- | | |
|-----------|---------------|
| 3 = 20 mm | FM-63-2305-20 |
| 4 = 22 mm | FM-63-2305-22 |
| 5 = 24 mm | FM-63-2305-24 |

Mouth mirror handles EN

Mundspiegelgriff DE

Manches pour miroirs à bouche ES

Mangos para espejos de boca FR

Manici per specchietti IT

63



MOUTH JMRRORS



FM-63-2306-01
4,5 cm/13/4



FM-63-2306-02
Handle only

HILGER
FM-63-2306-00
18 cm/7"



FM-63-2307-14
Hollow



FM-63-2308-14
Hollow



FM-63-2309-14
Hollow



FM-63-2310-14
Hollow

Mirror handles are available with Cone Socket and Simple Stem Fittings
Metric / US Threads, Please specify while ordering

EN	Mouth mirror handles
DE	Mundspiegelgriff
ES	Manches pour miroirs á bouche
FR	Mangos para espejos de boca
IT	Manici per specchietti



FM-63-2311-12
Hollow



FM-63-2312-12
Solid



FM-63-2313-12
Solid



FM-63-2314-12
Solid



FM-63-2315-00
Solid



FM-63-2316-00
Hollow

Mirror handles are available with Cone Socket and Simple Stem Fittings
Matric / US Threads, Please specify while ordering

EN	Amalgam Instruments
DE	Amalgam Instrumente
ES	Instrumentos de amalgama
FR	Instruments Amalgam
IT	Strumenti amalgama

Page 116 to 117

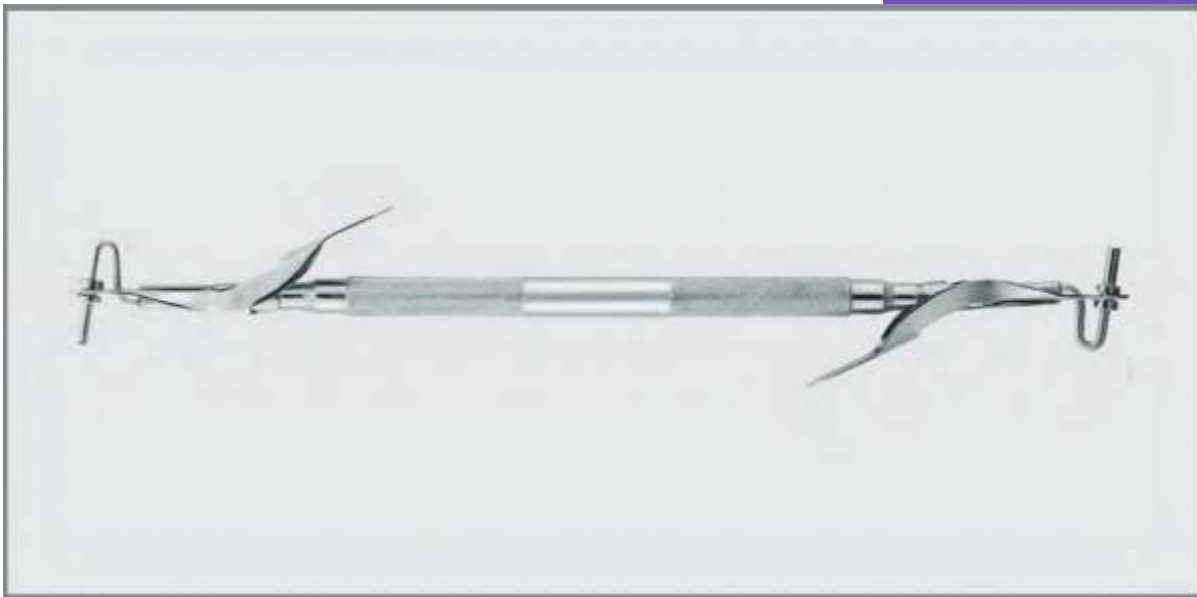

EN	Amalgam Guns
DE	Knochenfeilen
ES	Limes à os
FR	Lima para huesos
IT	Lima per ossa



AMALGAM



with metal tip
with plastic tip

FM-64-2351
FM-64-2352

FM-64-2353
FM-64-2354

FM-64-2355
FM-64-2356

FM-64-2357
FM-64-2358

Amalgam Carriers **EN**

Knochenfeilen **DE**

Limes à os **ES**

Lima para huesos **FR**

Lima per ossa **IT**

64



AMALGAM

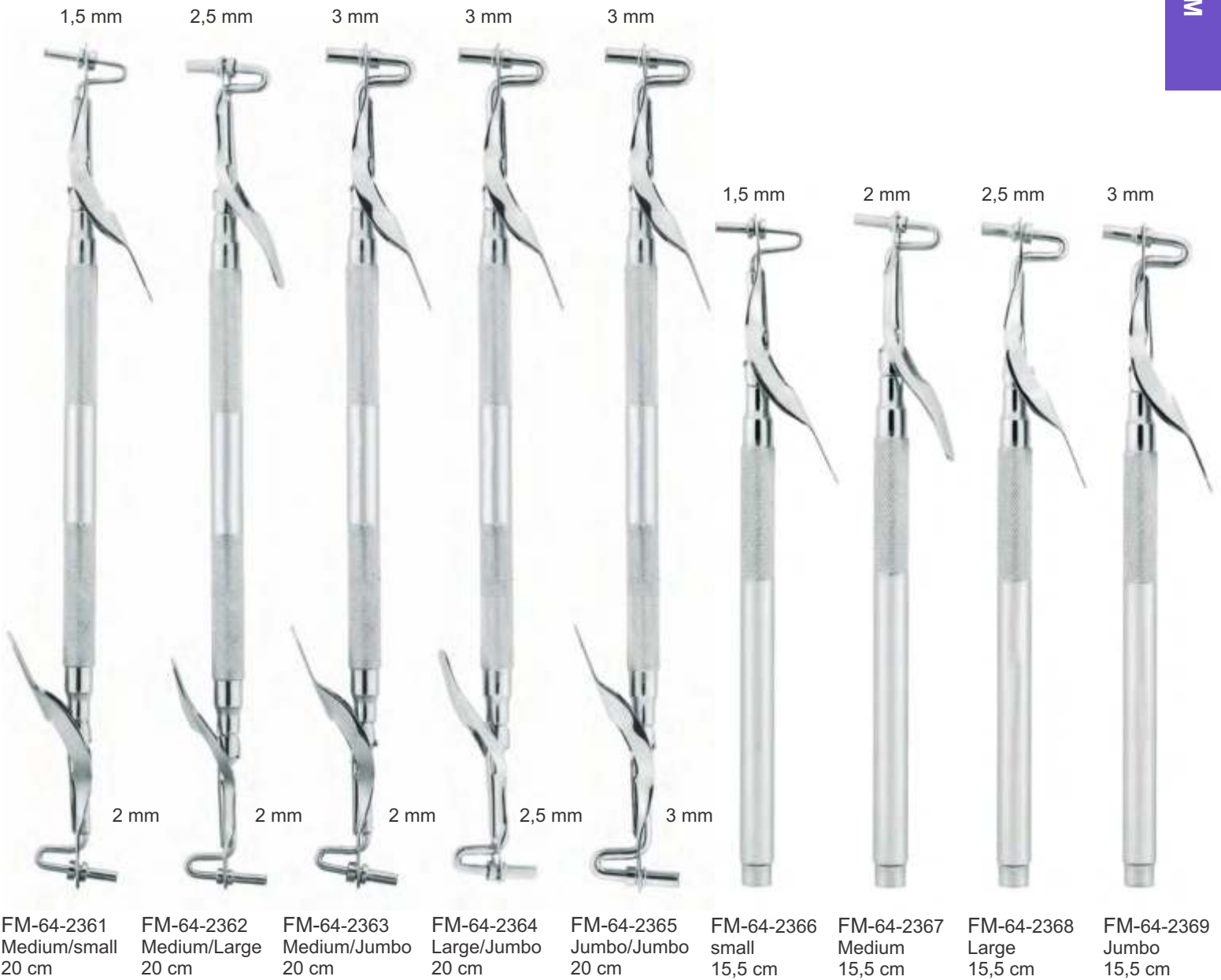

EN	Matrix Retainers
DE	Matrix-Halterungen
ES	Retenedores de matrices
FR	Retenue de matrice
IT	Matrix Retainers

Page 118 to 125



EN	Matrix Retainers
DE	Knochenfeilen
ES	Limes à os
FR	Lima para huesos
IT	Lima per ossa



MATRIX RETAINERS



¼

Tof emire-Universal
FM-0,65-2601



¼

Tof emire-Senior
FM-0,65-2602



¼

Tof emire-Junior
FM-0,65-2603



¼

Fig.1
Nystrom
left
FM-0,65-2604



¼

Fig.2
Nystrom
right
FM-0,65-2605



¼

Ivory 8
FM-0,65-2606 5 mm
FM-0,65-2607 6 mm
FM-0,65-2608 7 mm



¼

Ivory 8N
FM-0,65-2609



¼

Didner 8P
FM-0,65-2610

adjustable

Matrix Retainers	EN
Knochenfeilen	DE
Limes à os	ES
Lima para huesos	FR
Lima per ossa	IT

65



Ivory
FM-0,65-2611
Fig. 1



Ivory
FM-0,65-2612
Fig. 12



Ivory
FM-0,65-2613
Fig. 12A

EN Rubber Dam Instruments

DE Knochenfeilen

ES Limes à os

FR Lima para huesos

IT Lima per ossa



Ainsworth
FM-0,65-2614
16 cm / 6 1/2"



Ainsworth
FM-0,65-2615
16 cm / 6 1/2"



Ivory
FM-0,65-2616
15 cm / 6"



Ivory
FM-0,65-2617
15 cm / 6"



Ivory
FM-0,65-2618
17 cm / 6 3/4"



Brewer
FM-0,65-2619
17 cm / 6 3/4"

Rubber Dam Instruments **EN**

Knochenfeilen **DE**

Limes à os **ES**

Lima para huesos **FR**

Lima per ossa **IT**

65



MATRIX RETAINERS



Stockes
FM-0,65-2620
17 cm / 6 3/4"

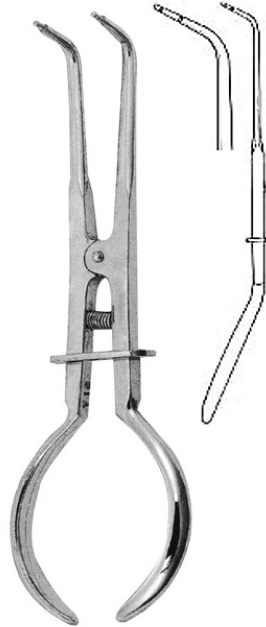

Stockes
FM-0,65-2621
17 cm / 6 3/4"



Palmer
FM-0,65-2622
17 cm / 6 3/4"



White
FM-0,65-2623
17 cm / 6 3/4"



Band Pusher-Mershon
FM-0,65-2624
14 cm / 5 1/2"

EN Rubber Dam Clamps

DE Knochenfeilen

ES Limes à os

FR Lima para huesos

IT Lima per ossa



FM-0,65-2626
Fig. 00
Anterior Teeth



FM-0,65-2627
Fig. 0
Premolars



FM-0,65-2628
Fig. 1
Premolars



FM-0,65-2629
Fig. 1A
Premolars



FM-0,65-2630
Fig. 2
Premolars



FM-65-2631
Fig. 2A
Premolars



FM-65-2632
Fig. 2AS
Premolars



FM-65-2633
Fig. 3
Lower Molars



FM-65-2634
Fig. 4
Upper Molars



FM-65-2635
Fig. 5
Upper Molars



FM-0,65-2636
Fig. 6
Anterior Teeth



FM-0,65-2637
Fig. 7
Lower Molars



FM-0,65-2638
Fig. 7A
Lower Molars



FM-0,65-2639
Fig. 8
Upper Molars



FM-0,65-2640
Fig. 8A
Molars General



FM-0,65-2641
Fig. 9
Anterior Teeth



FM-0,65-2642
Fig. 9S
Anterior Teeth



FM-0,65-2643
Fig. 10
Molars General



FM-0,65-2644
Fig. 11
Molars General



FM-0,65-2645
Fig. 24
Molars General



FM-0,65-2646
Fig. 25
Molars General



FM-0,65-2647
Fig. 26
Lower Molars



FM-0,65-2648
Fig. 26N
Molars General



FM-0,65-2649
Fig. 27
Molars General

Rubber Dam Clamps **EN**
 Knochenfeilen **DE**
 Limes à os **ES**
 Lima para huesos **FR**
 Lima per ossa **IT**

65



MATRIX RETAINERS



FM-0,65-2650
Fig. 27N
Premolars



FM-0,65-2651
Fig. 28
Lower Molars



FM-0,65-2652
Fig. 29
Lower Molars



FM-0,65-2653
Fig. 30
Upper Molars



FM-0,65-2654
Fig. 31
Upper Molars



FM-0,65-2655
Fig. 56
Molars General



FM-0,65-2656
Fig. 56S
Molars General



FM-0,65-2657
Fig. 201
Upper Molars



FM-0,65-2658
Fig. 205
Upper Molars



FM-0,65-2659
Fig. 212
Anterior Teeth



FM-0,65-2660
Fig. 212SA
Anterior Teeth



FM-0,65-2661
Premolars
12-0665-W2



FM-0,65-2662
Fig. W3
Lower Molars



FM-0,65-2663
Fig. W4
Upper Molars



FM-0,65-2664
Fig. W7
Lower Molars



FM-0,65-2665 Frame - Child
13 cm/5"
FM-0,65-2666 Frame - Adult
15 cm/6"



FM-0,65-2667
Beerendonk

FM-0,65-2668
Boley



Iwanson
One side graugation
FM-0,65-2669 Metal
FM-0,65-2670 Wax

Double side graugation
FM-0,65-2671 Metal
FM-65-2672 Wax

Rubber Dam Clamps	EN
Knochenfeilen	DE
Limes à os	ES
Lima para huesos	FR
Lima per ossa	IT

65



MATRIX RETAINERS

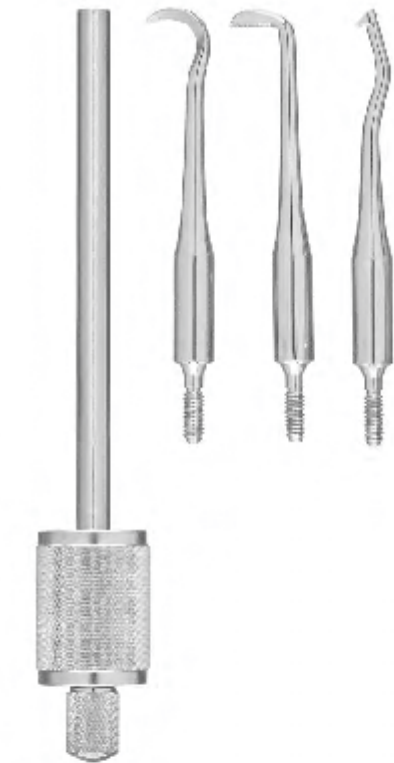

FM-65-2673
Morrel
Crown Remover



FM-65-2674
Crown Remover
Manual



FM-65-2675
Crown Remover
Manual



FM-65-2676
Crown Remover
Automatic



FM-65-2677
Crown Remover
Automatic

EN	Hemostatic Forceps
DE	Arterienklemmen
ES	Pinces hemostaticas
FR	Pinzashemostaticas
IT	Pinze emostatiche

Page 126 to 132



EN	Artery Forceps
DE	Arterienklemmen
ES	Pinzas hemostáticas
FR	Forceps de l'artère
IT	Arteria Forcipe



ARTERY FORCEPS



Halsted-Mosquito



FM-66-2701
12.5 cm/5"



FM-66-2702
14.5 cm/5 3/4"



FM-66-2703
14 cm/5 1/2"



FM-66-2704
12.5 cm/5"
1:2



FM-66-2705
14.5 cm/5 3/4"
1:2



FM-66-2706
12 cm/4 3/4"
1:2



FM-66-2707
14 cm/4 1/2"
1:2



Micro-Mosquito



FM-66-2708
10 cm/4"



FM-66-2709
12 cm/4 3/4"



FM-66-2710
9.5 cm/3 1/2"



FM-66-2711
11.5 cm/4 1/2"



JM-66-2712
10 cm/4"
1:2



JM-66-2713
12 cm/4 3/4"
1:2



JM-66-2714
10 cm/4"
1:2



JM-66-2715
12 cm/4 3/4"
1:2

Artery Forceps	EN
Arterienklemmen	DE
Pinzas hemostáticas	ES
Forceps de l'artère	FR
Arteria Forcipe	IT

66



ARTERY FORCEPS



Halsted-Mosquito



FM-66-2716
18 cm/7"



FM-66-2717
18 cm/7"



FM-66-2718
18 cm/7"
1:2



FM-66-2719
18 cm/7"
1:2

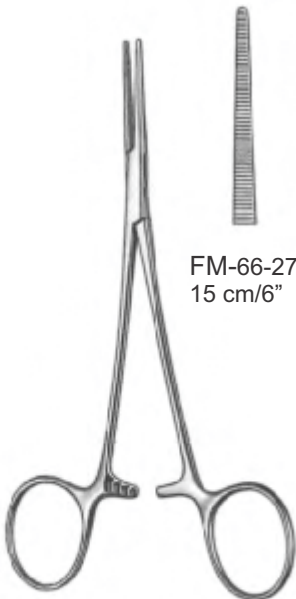

Leriche



FM-66-2720
15 cm/6"



FM-66-2721
15 cm/6"



FM-66-2722
15 cm/6"
1:2



FM-66-2723
15 cm/6"
1:2



FM-66-2724
15 cm/6"



FM-66-2725
15 cm/6"

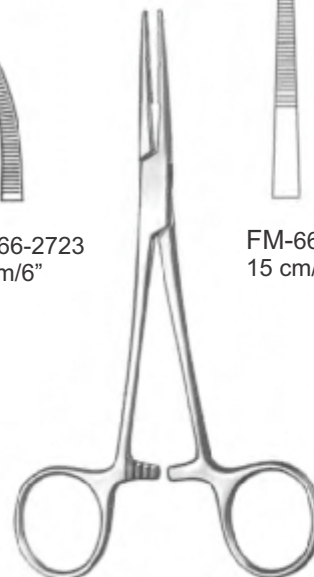

Kelly

EN	Artery Forceps
DE	Arterienklemmen
ES	Pinzas hemostáticas
FR	Forceps de l'artère
IT	Arteria Forcipe

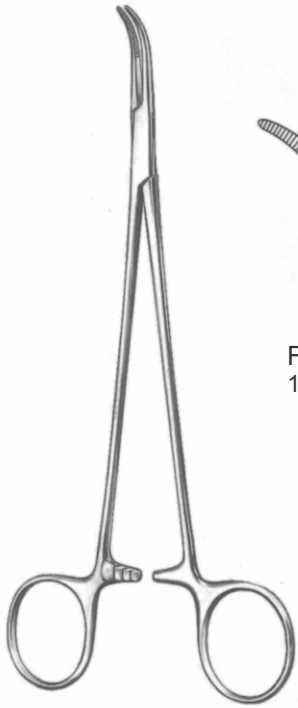

Mixer-Baby



FM-66-2726
18.5 cm/7 ¼"

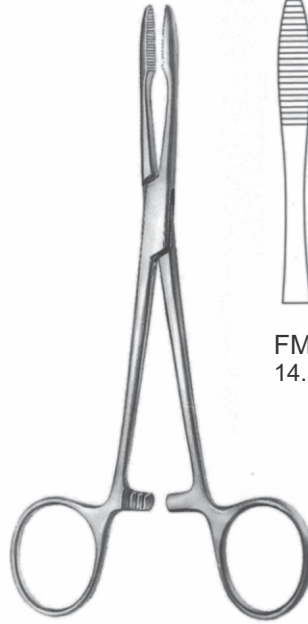

Pean



FM-66-2727
14.5 cm/5 ¾"



FM-66-2728
16 cm/6 ¼"



Pean

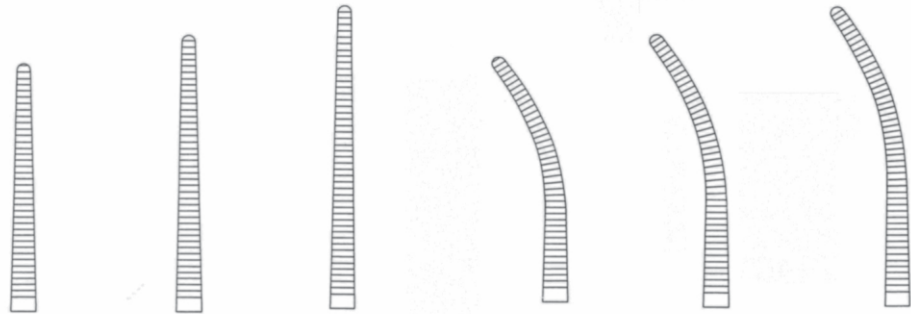

FM-66-2729
13 cm/5"

FM-66-2730
14 cm/5 ½"

FM-66-2731
17 cm/6 ¾"

FM-66-2732
13 cm/5"

FM-66-2733
14 cm/5 ½"

FM-66-2734
17 cm/6 ¾"

Artery Forceps	EN
Arterienklemmen	DE
Pinzas hemostáticas	ES
Forceps de l'artère	FR
Arteria Forcipe	IT

66



FAIZAN & MUSA
SURGICAL

ARTERY FORCEPS

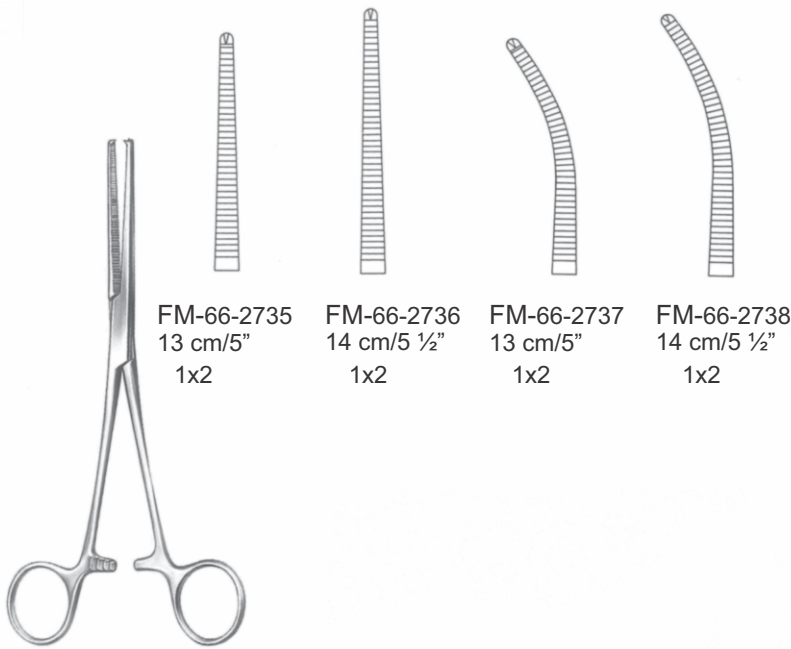

FM-66-2735
13 cm/5"
1x2

FM-66-2736
14 cm/5 1/2"
1x2

FM-66-2737
13 cm/5"
1x2

FM-66-2738
14 cm/5 1/2"
1x2

Kocher

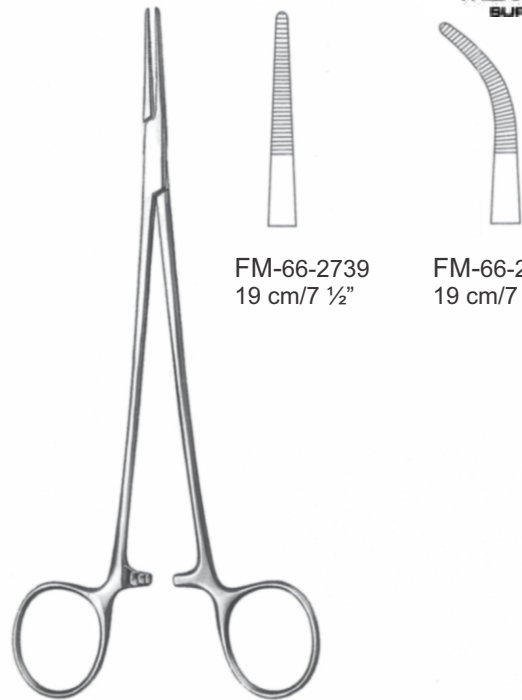

FM-66-2739
19 cm/7 1/2"

FM-66-2740
19 cm/7 1/2"

Adson

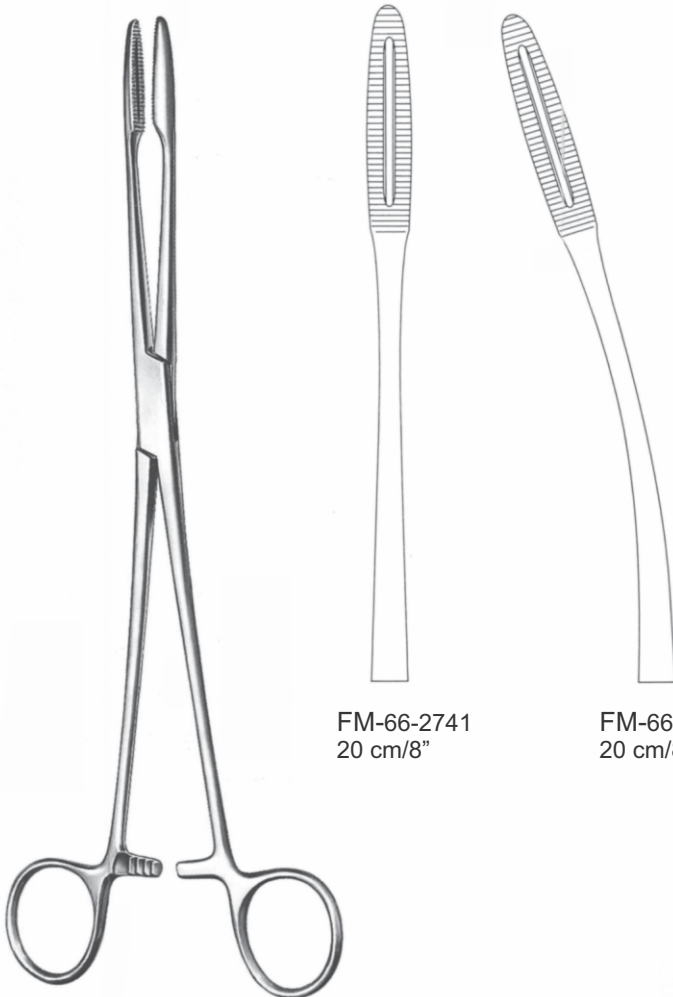

FM-66-2741
20 cm/8"

FM-66-2742
20 cm/8"

Gross-Maier

ATRAUMA

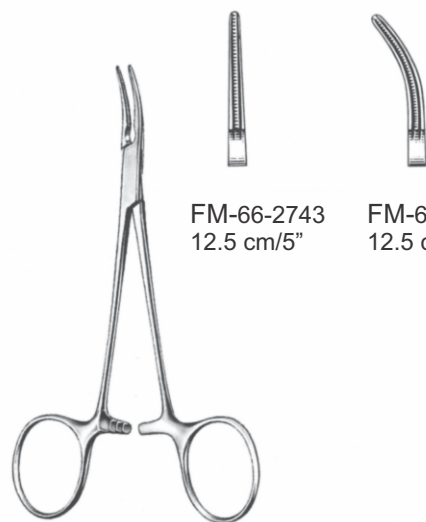

FM-66-2743
12.5 cm/5"

FM-66-2744
12.5 cm/5"

DeBakey-Mosquito

EN	Artery Forceps
DE	Arterienklemmen
ES	Pinzas hemostáticas
FR	Forceps de l'artère
IT	Arteria Forcipe



ARTERY FORCEPS



Babcock

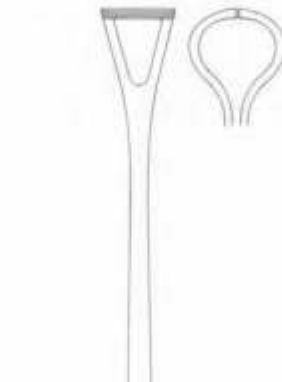

- FM-66-2745 16 cm/6 1/4"
- FM-66-2746 18 cm/7 1/8"
- FM-66-2747 20 cm/7 7/8"
- FM-66-2748 24 cm/9 1/2"



Babcock



FM-66-2749TC
16 cm/6 1/2"



ATRAUMA



BABCOCK
FM-66-2750
16 cm/9 1/4"

ATRAUMA

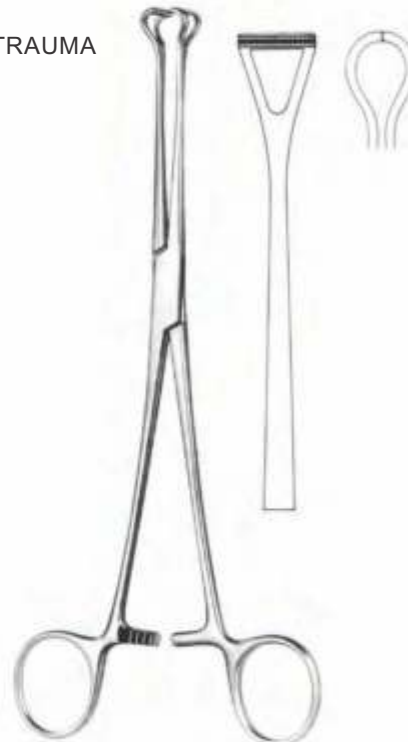

BABCOCK
FM-66-2751
20.5 cm/8 1/8"

Artery Forceps	EN
Arterienklemmen	DE
Pinzas hemostáticas	ES
Forceps de l'artère	FR
Arteria Forcipe	IT

66



Allis

FM-66-2752
15.5 cm/6"
4:5



FM-66-2753
15.5 cm/6"
5:6



FM-66-2754
19 cm/7 1/2"
5:6



Allis-Baby

FM-66-2755
12 cm/5"
4:5



EN Artery Forceps

DE Arterienklemmen

ES Pinzas hemostáticas

FR Forceps de l'artère

IT Arteria Forcipe

ATRAUMA



Allis



FM-66-2756
16 cm/6 1/2"



FM-66-2757
20 cm/8"

- EN** Towel Clamps
- DE** Handtuchklammern
- ES** Abrazaderas de toalla
- FR** Pincés à serviettes
- IT** Morsetti per asciugamano

Page 133 to 134



EN	Towel Clamps
DE	Handtuchklammern
ES	Abrazaderas de toalla
FR	Pinces à serviettes
IT	Morsetti per asciugamano



TOWEL CLAMPS

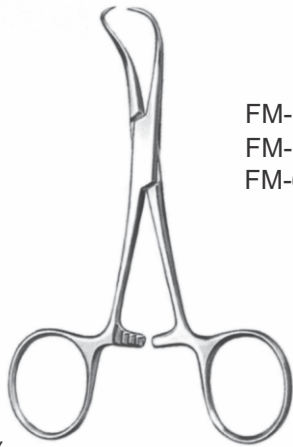

1/2

Backhaus

- FM-67-2801 9 cm/3 1/2"
- FM-67-2802 11.5 cm/4 1/2"
- FM-67-2803 13 cm/5"



1/2

for paper clothes

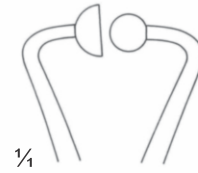

1/4

- FM-67-2804 11.5 cm/4 1/2"

- FM-67-2805 14 cm/5 1/2"



1/2

Peers-Bertram
FM-67-2806
14.5 cm/5 3/4"

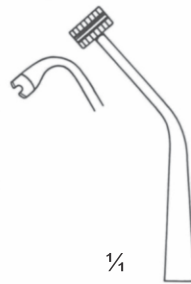

1/4

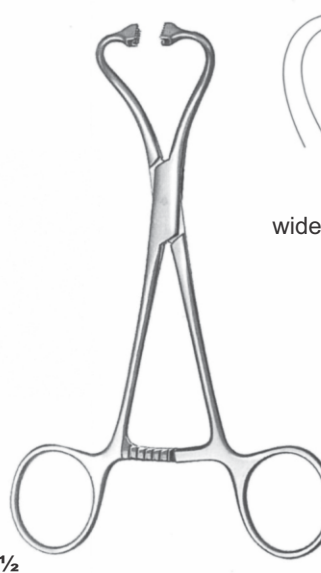

1/2

Peers-Bertram modif.
FM-67-2807
15.5 cm/6"

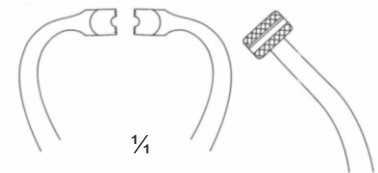

1/4

wide jaw for tube xation

Towel Clamps	EN
Handtuchklammern	DE
Abrazaderas de toalla	ES
Pinces à serviettes	FR
Morsetti per asciugamano	IT

67



FAIZAN & MUSA
SURGICAL

TOWEL CLAMPS



1/2

Tohoku



1/4

FM-67-2808
10.5 cm/4"

FM-67-2809
13.5 cm/5 1/4"



1/2

Schadel
FM-67-2810
8.5 cm/3 1/2"
sharp



1/2

Jones
sharp

FM-67-2811
8.5 cm/3 1/4"

EN	Needle Holders
DE	Nadelhalter
ES	Porte-aiguilles
FR	Porta-agujcs
IT	Port' aghi

Page 135 to 143



EN	Needle Holders
DE	Nadelhalter
ES	Porta agujas
FR	Porte-aiguilles
IT	Porta-aghi

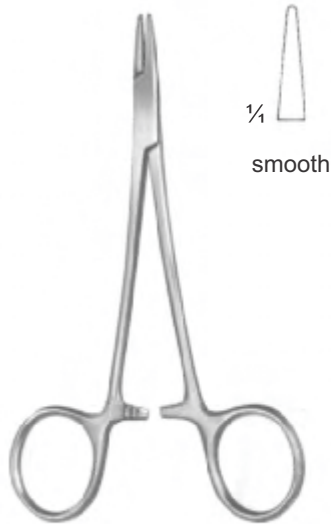

¼
smooth

Webster
FM-68-2901
13 cm/5 1/8"

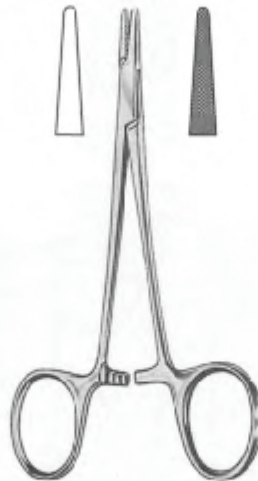

¼
¼

Halsey
FM-68-2902 13 cm/5 1/8" Plain
FM-68-2903 13 cm/5 1/8" Serrated



¼

Derf
FM-68-2904
12 cm/4 3/4"
one fenestrated jaw



¼

Crile-Wood
FM-68-2905
15 cm/5 7/8"



¼

Crile-Murray
FM-68-2906
15 cm/5 7/8"
slender pattern



¼

Adson
FM-68-2907
18 cm/7 1/8"
one fenestrated jaw

Needle Holders	EN
Nadelhalter	DE
Porta agujas	ES
Porte-aiguilles	FR
Porta-aghi	IT

68



NEEDLE HOLDERS

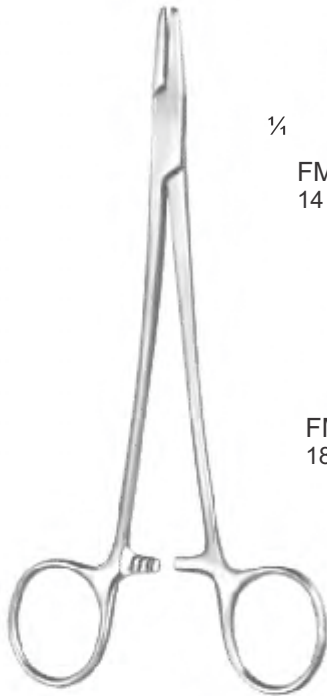

MAYO-HEGAR

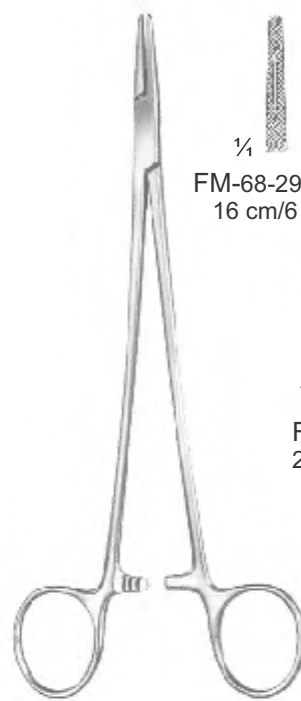
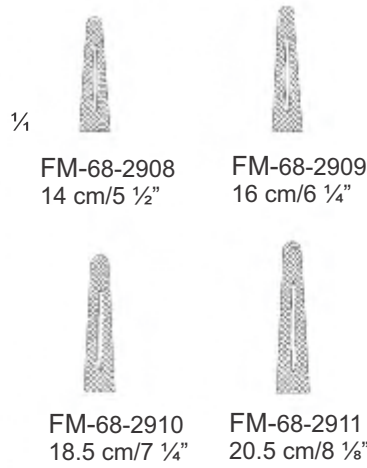

MAYO-HEGAR
slender pattern

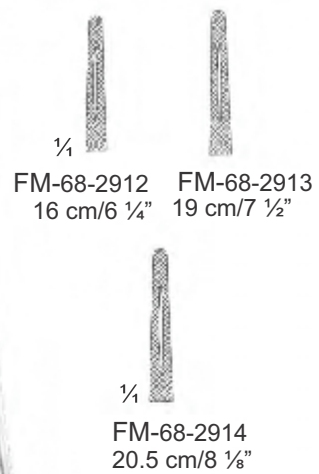

HEGAR-BAUMGARTNER
FM-68-2915
14 cm/5 1/2"



MATHIEU

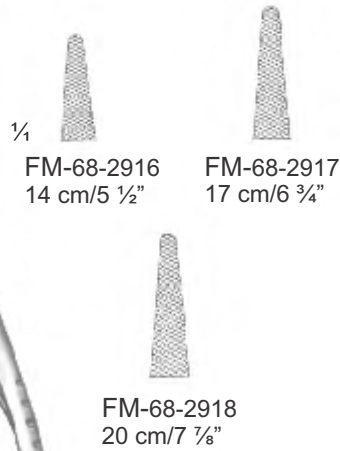

MATHIEU
slender pattern

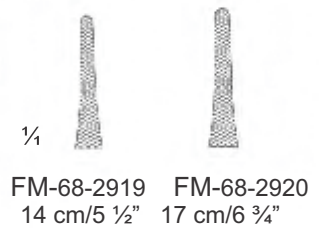

EN	Needle Holders
DE	Nadelhalter
ES	Porta agujas
FR	Porte-aiguilles
IT	Porta-aghi



Lichtenberg
FM-68-2921
20 cm/7 7/8"



Toennis
FM-68-2922
18.5 cm/7 1/4"



Crile
FM-68-2923
15 cm/5 7/8"

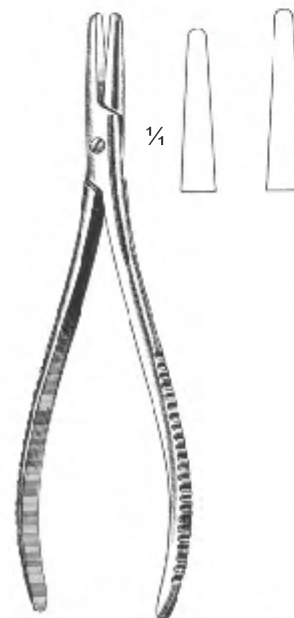

Langenbeck
FM-68-2924 16 cm/6 1/4"
FM-68-2925 20 cm/7 7/8"

Needle Holders	EN
Nadelhalter	DE
Porta agujas	ES
Porte-aiguilles	FR
Porta-aghi	IT

68



NEEDLE HOLDERS

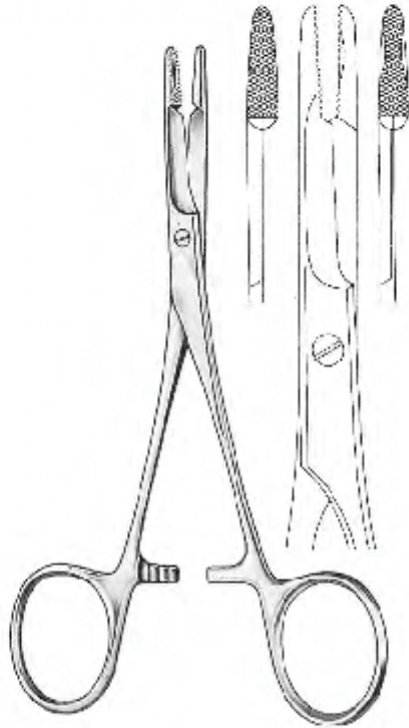

Olsen-Hegar

- FM-68-2926 11 cm/4 1/8"
- FM-68-2927 14 cm/5 1/2"
- FM-68-2928 18 cm/7 1/8"
- FM-68-2929 19 cm/7 1/2"

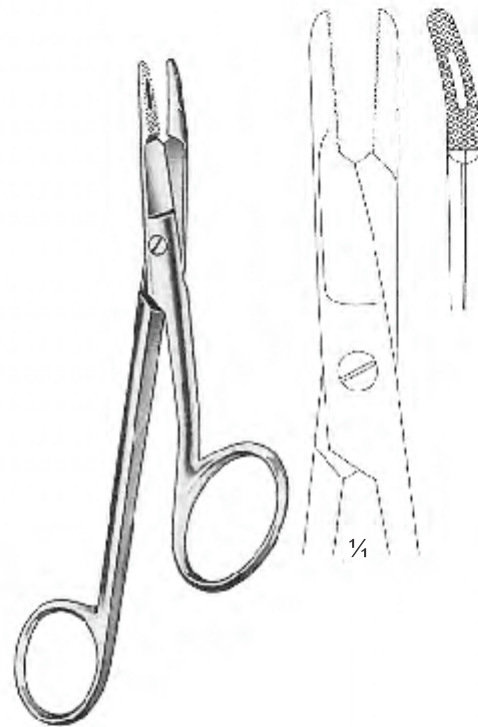

Gillies

- FM-68-2930 Right hand
- FM-68-2931 Left hand
- 16 cm/6 1/4"

EN	Needle Holders
DE	Nadelhalter
ES	Porta agujas
FR	Porte-aiguilles
IT	Porta-ago



NEEDLE HOLDERS



¼
 FM-68-2932
 13 cm/5 ½
 smooth jaw

¼
 FM-68-2933
 13 cm/5 ½
 0.4 mm

HALSEY



¼
 FM-68-2934
 smooth jaw

¼
 FM-68-2935
 0.4 mm

WEBSTER
 12.5 cm/4 ¾"



DERF
 FM-68-2936
 12 cm/4 ¾"



0.5 mm

Toennis
 FM-68-2937
 18 cm/7 ½"



0.5 mm
 FM-68-2938
 18.5 cm/7 ¼"

0.5 mm
 FM-68-2939
 20.5 cm/8 ½"

Langenbeck

0.5 mm
 FM-68-2940
 23 cm/9"

Needle Holders	EN
Nadelhalter	DE
Porta agujas	ES
Porte-aiguilles	FR
Porta-aghi	IT

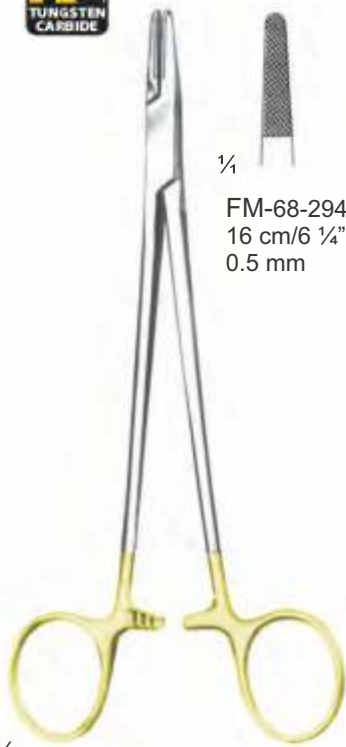

1/2

Mayo-Hegar
standard pro le

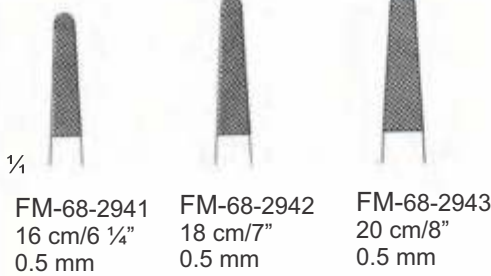

1/4

FM-68-2941 16 cm/6 1/4" 0.5 mm
 FM-68-2942 18 cm/7" 0.5 mm
 FM-68-2943 20 cm/8" 0.5 mm



1/2

Debakey
mini pro le

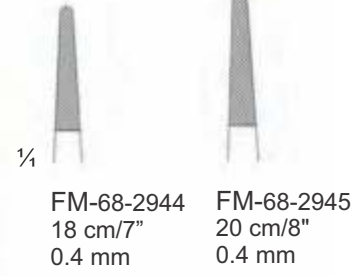

1/4

FM-68-2944 18 cm/7" 0.4 mm
 FM-68-2945 20 cm/8" 0.4 mm



1/2

HEGAR-BAUMGARTNER

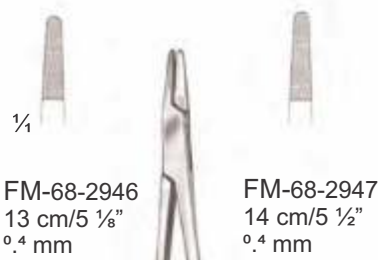

1/4

FM-68-2946 13 cm/5 1/8" 0.4 mm
 FM-68-2947 14 cm/5 1/2" 0.4 mm



1/2

Mathieu
Standard Pro le

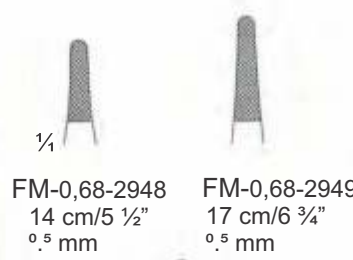

1/4

FM-0,68-2948 14 cm/5 1/2" 0.5 mm
 FM-0,68-2949 17 cm/6 3/4" 0.5 mm



1/2

Mathieu
Standard Pro le

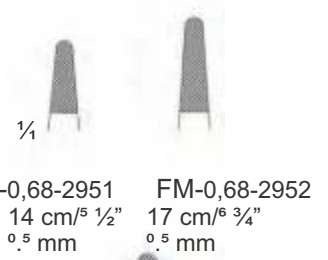

1/4

FM-0,68-2951 14 cm/5 1/2" 0.5 mm
 FM-0,68-2952 17 cm/6 3/4" 0.5 mm



FM-0,68-2953
 20 cm/8" 0.5 mm

EN	Needle Holders
DE	Nadelhalter
ES	Porta agujas
FR	Porte-aiguilles
IT	Porta-aghi



Mathieu



FM-0,68-2954
17 cm/6 3/4"
0.5 mm



FM-0,68-2955
20 cm/8"
0.5 mm



FM-0,68-2956
23 cm/9"
0.5 mm

with interior ratchet
standard pro le



Lichtenberg
FM-0,68-2957
20 cm/7 7/8"



0.5 mm



Zweifel



FM-0,68-2958
20.5 cm/8"
0.5 mm



FM-0,68-2959
23 cm/9"
0.5 mm

with hinged rehet
Standard Pro le

Needle Holders **EN**
 Nadelhalter **DE**
 Porta agujas **ES**
 Porte-aiguilles **FR**
 Porta-aghi **IT**

68



FAIZAN & MUSA
SURGICAL



NEEDLE HOLDERS



1/2

1/4

FM-0,68-2960
14.5 cm/5 3/4"
0.5 mm

FM-0,68-2961
17 cm/6 3/4"
0.5 mm

FM-0,68-2962
19 cm/9 1/2"
0.5 mm

standard pro le

Olsen-Hegar



1/4

FM-0,68-2963
16 cm/6 1/4"
0.5 mm

standard pro le

Gillies



1/4

FM-0,68-2964
11 cm/4 1/4"

smooth jaw

Foster-Gillies



1/4

FM-0,68-2965
15 cm/6"
0.4 mm

mini pro le

Gillies-Mini

EN	Needle Holders
DE	Nadelhalter
ES	Porta agujas
FR	Porte-aiguilles
IT	Porta-aghi



FAIZAN & MUSA
SURGICAL



NEEDLE HOLDERS



1/4
FM-0,68-2966
12 cm/4 3/4"
with lock

1/2
Castroviejo



1/4
FM-68-2967
12 cm/4 3/4"
with lock

1/2
Castroviejo



1/4
FM-68-2968
12.5 cm/5"
with lock, smooth jaw

1/2
Castroviejo



1/2
Castroviejo



1/4
FM-68-2969
14.5 cm/5 3/4"
with lock
micro pro le
0.3 mm



FM-68-2970
14.5 cm/5 3/4"
with lock
micro pro le
0.3 mm



FM-68-2971
14.5 cm/5 3/4"
smooth jaw
0.3 mm



FM-68-2972
18 cm/7"
with lock
micro pro le
0.3 mm



FM-68-2973
21.5 cm/8 1/2"
with lock
micro pro le
0.3 mm



1/4
FM-68-2974
14.5 cm/5 3/4"
smooth jaw



FM-68-2975
18 cm/7"
with lock
micro pro le
0.3 mm



FM-68-2976
21.5 cm/8 1/2"
with lock
micro pro le
0.3 mm

EN	Retractors
DE	Wundhaken
ES	Ecarteurs
FR	Separadores
IT	Divaricatori

Page 144 to 148



EN	Retractors
DE	Wundhaken
ES	Ecarteurs
FR	Separadores
IT	Divaricatori



RETRACTORS



Fig. 2 = 30 x 10 mm
Fig. 1 = 26 x 10 mm

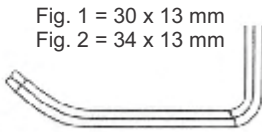

Fig. 1 = 30 x 13 mm
Fig. 2 = 34 x 13 mm

FARABEU
FM-69-3001
12 cm/4 3/4"
Fig. 1 - 2



ROUX
FM-69-3002
Set complete, Fig. 1- 3

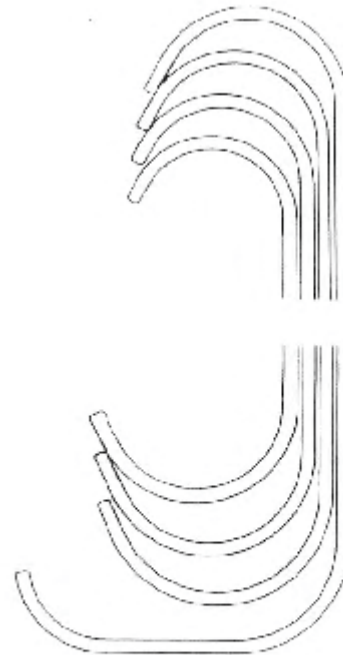
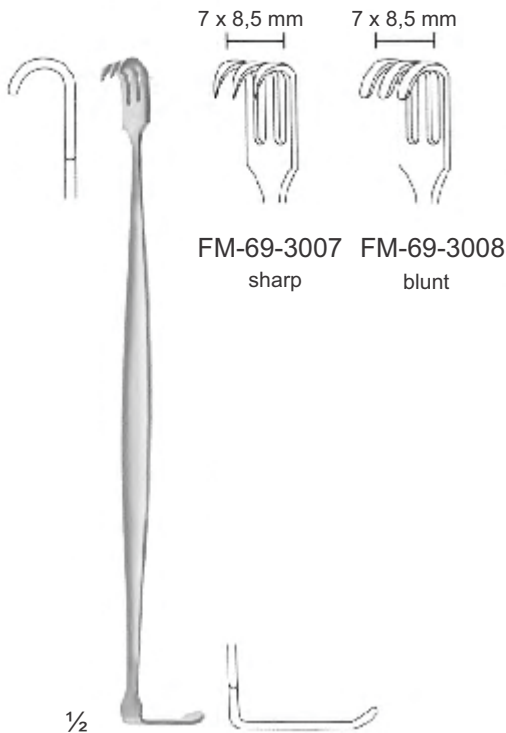
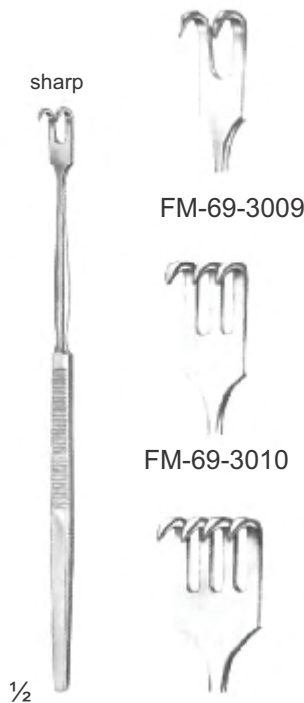

Fig. 1	14 cm/5 1/2"	FM-69-3003	24 x 20 / 30 x 28
Fig. 2	15 cm/6"	FM-69-3004	29 x 26 / 36 x 36
Fig. 3	17 cm/6 3/4"	FM-69-3005	23 x 29 / 38 x 43
Fig. 4	18 cm/7"	FM-69-3006	29 x 24 / 45 x 28



SENN
17 cm/6 3/4"



16 cm/6 1/4" JM-69-3011



16 cm/6 1/4" JM-69-3014

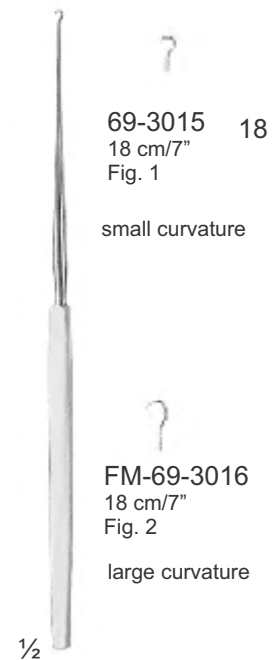

GILLIES
18 cm/7"

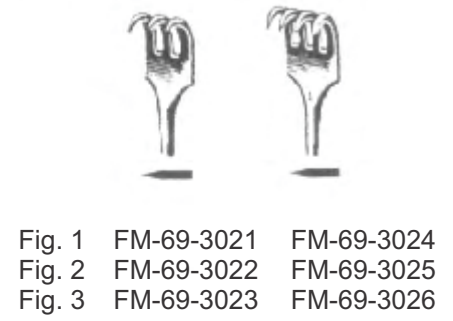
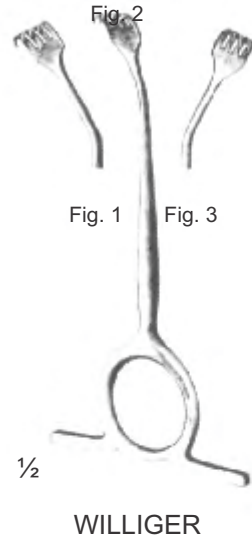
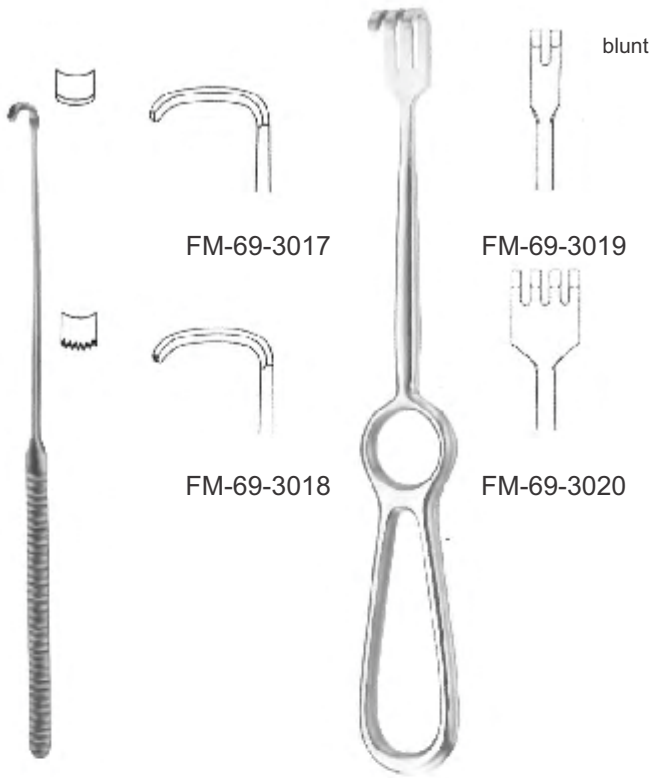

STRANDELL-STILLE
 19, cm/7 1/2"

VOLKMANN
 21,5 cm/8 1/2"



LANGENBECK
 22 cm/8 3/4"

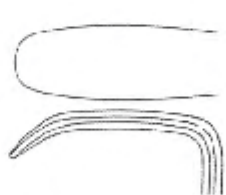

FM-69-3027
 30x 11 mm



FM-69-3029
 30x 16 mm



FM-69-3028
 30x 14 mm

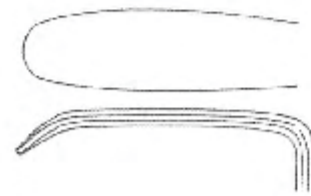

FM-69-3030
 40x 11 mm

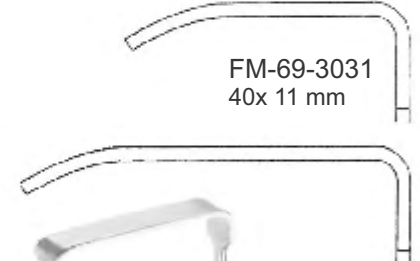

FM-69-3031
 40x 11 mm



KOCHER-LANGENBECK
 22 cm/8 1/2"

EN Cheek retractors

DE Wangenhalter

ES Ecarteurs des joues

FR Separatori per guancia

IT Separadores para mejillas

FAIZAN & MUSA
SURGICAL

JMDDELDORPF

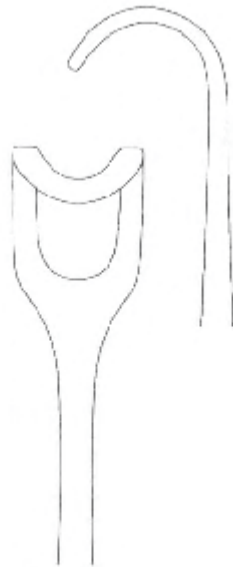
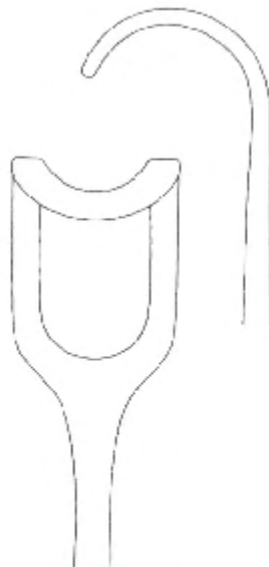
FM-69-3033
21,5 cm/8 1/2"
14 x 17 mmFM-69-3034
22 cm/8 3/4"
20 x 22 mmKOCHER LANGENBECK
FM-69-3035
21 cm/8 1/4"
23 x 8 mmWARD
FM-69-3036
15,5 cm/6"BOWDLER=HENRY
FM-69-3037
16 cm/6 1/4"KAY (AUSTIN)
FM-69-3038

Chin retractor	EN
Kinnhalter	DE
Fixe menton	ES
Gancho de mentión	FR
Guancio per mento	IT

69



RETRACTORS

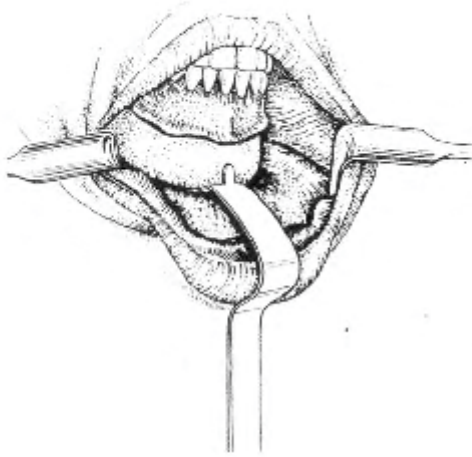

16,5 mm

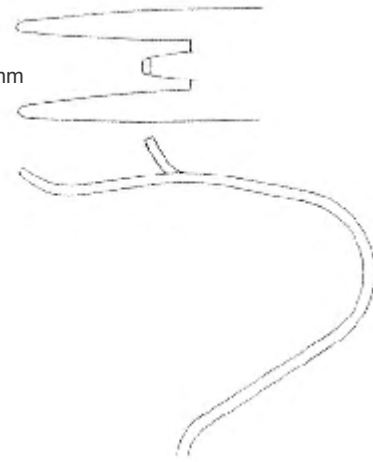

OBWEGESER
FM-69-3039
16 cm/6 1/4"

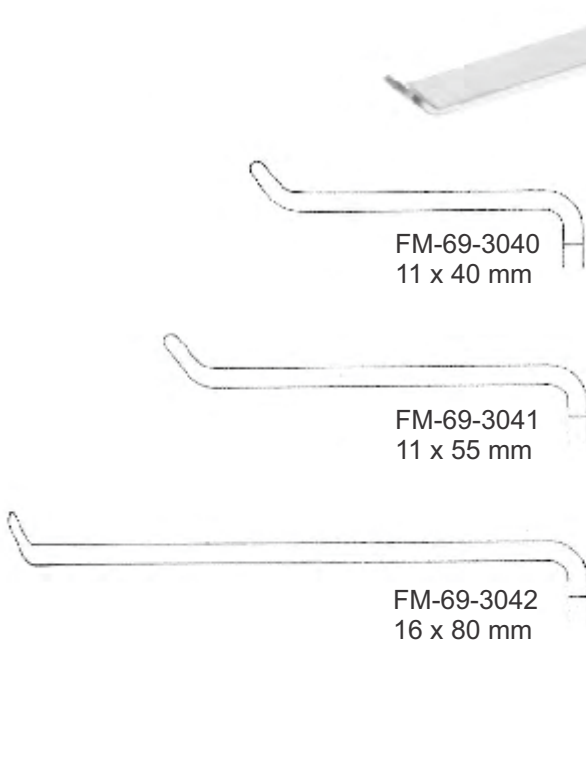

FM-69-3040
11 x 40 mm

FM-69-3041
11 x 55 mm

FM-69-3042
16 x 80 mm

OBWEGESER
21,5 cm/8 1/2"



FM-69-3043
30 x 9/12 mm

FM-69-3044
45 x 9/12 mm

FM-69-3045
60 x 9/12 mm

OBWEGESER

EN	Cheek retractors
DE	Wangenhalter
ES	Ecarteurs des joues
FR	Separatori per guancia
IT	Separadores para mejillas



RETRACTORS



FM-69-3046
7 cm/2 3/4"
sharp

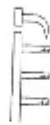

FM-69-3047
10 cm/4"
sharp

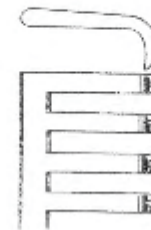
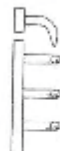

FM-69-3048
13 cm/4 1/4"
3 : 4
sharp



FM-69-3049
13 cm/4 1/4"
3 : 4
blunt

EN	Mouth and Tongue
DE	Mund und Zunge
ES	Boca y la lengua
FR	Bouche et langue
IT	Bocca e la lingua

Page 149 to 152



EN Mouth gags

DE Mundsperrer

ES Ouvre-bouche

FR Abrebocas

IT Apribocca

FAIZAN & MUSA
SURGICAL

DOYEN-JANSEN (MOLT)
FM-70-3100 9 cm/3 1/2"
FM-70-3101 11 cm/4 1/2"
FM-70-3102 14 cm/5 1/2"



DENHARDT
FM-70-3103
12 cm/5"



HEISTER
FM-70-3104
13 cm/5 1/4"



ROSIER-KOENIG
16 cm/6 1/4" FM-70-3105
19 cm/7 1/2" FM-70-3106



JENNINGS
9 cm/3 1/2" FM-70-3107
11 cm/4 1/2" FM-70-3108
13 cm/5" FM-70-3109
15 cm/6" FM-70-3110

24 x 27 mm



COLLIN
FM-70-3111
16 cm/6 1/2"



YOUNG
FM-70-3112
16 cm/6 1/2"

70-3113

Mouth gags	EN
Mundsperrer	DE
Ouvre-bouche	ES
Abrebocas	FR
Apribocca	IT

70



MOUTH GAGS

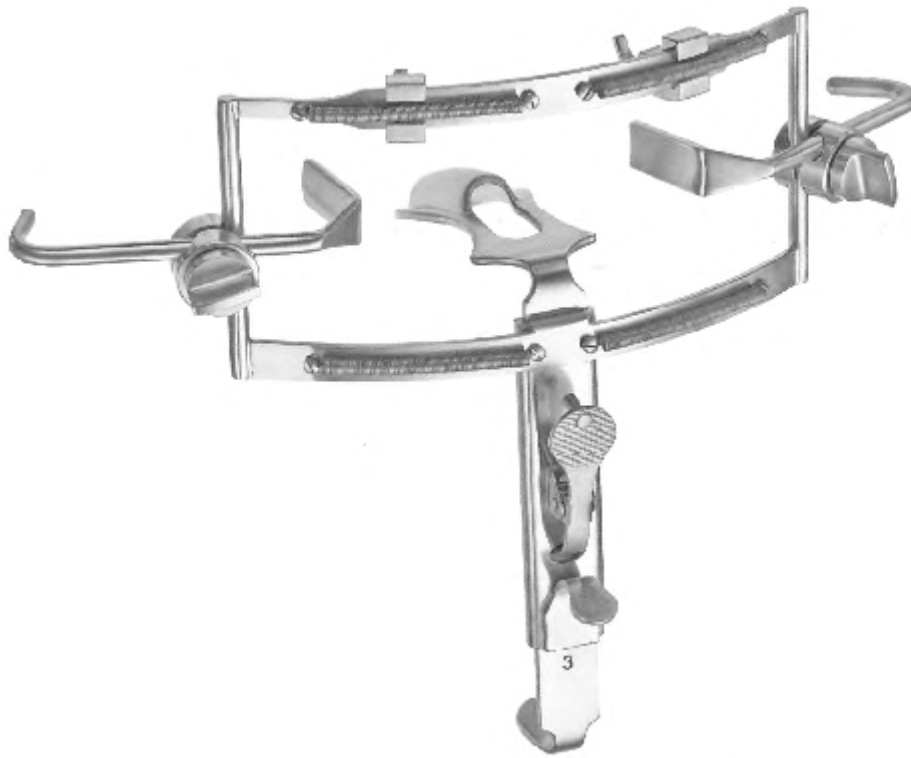

complete with frame,
3 tongue depressors,
2 tooth plates

DINGMANN
FM-70-3114
14,5 cm/5 3/4"



65 x 25 mm

FM-70-3115
13,5 cm/5 1/4"



70 x 29 mm

FM-70-3116
13,5 cm/5 1/4"



80 x 32 mm

FM-70-3117
13,5 cm/5 1/4"

EN	Tongue Depressors
DE	Zungenspateln
ES	Abaisse-langue
FR	Abajalengua
IT	Abbassalingua



MOUTH GAGS



FM-70-3118
16 cm/6 1/4"



FRENZEL
FM-70-3119
16,5 cm/6 1/2"

19 / 15 mm



BRUENINGS
FM-70-3120
19 cm/7 1/2"



BUCHWALD
FM-70-3121
19 cm/7 1/2"



HARTMANN
FM-70-3122
15 cm/6"



72 X 23 mm



DOYEN

24 / 30 mm



FM-70-3123
13,5 cm/5 1/4"

30 / 34 mm



FM-70-3124
16 cm/6 1/4"



WIEDER

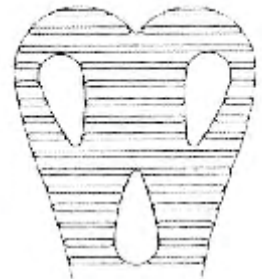

FM-70-3125
14 cm/5 1/2"
36 mm

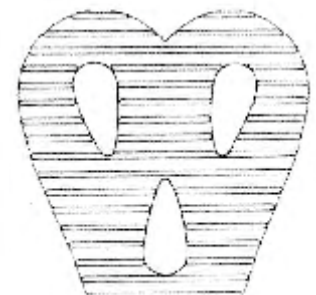

FM-70-3126
15 cm/6"
43 mm

Tongue Depressors, Check retractors	EN
Zungenspateln, Wangenhalter	DE
Abaisse-langue, Ecarteurs des joues	ES
Abajalengua, separatori per guancia	FR
Abbassalingua, Separadores para mejillas	IT

70



MOUTH GAGS



85 x 24 mm

TOBOLD
FM-70-3127
14,5 cm/5 ¾"

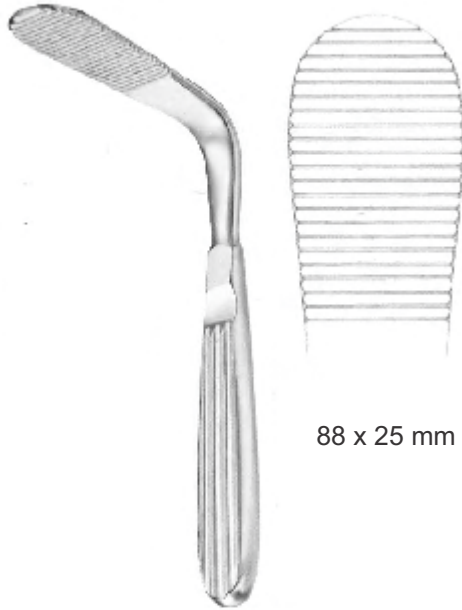

88 x 25 mm

TOBOLD
FM-70-3128
15 cm/6"



STERNBERG
FM-70-3129
14 cm/5 ½"



SIMPLEX
FM-70-3130
11 cm/4 ¼"



CAWOOD-JMNNESOTA
FM-70-3131
14 cm/5 ½"



CAWOOD-JMNNESOTA
FM-70-3132
15 cm/6"
20 mm



FM-70-3133
19 cm/7 ½"

EN	Scissors
DE	Schere
ES	Tijeras
FR	Les ciseaux
IT	Forbici

Page 153 to 171



EN	Wire Cutting Scissors
DE	Drahtscheren
ES	Tijeras para alambre
FR	Ciseaux de coupe de fil
IT	Forbici da taglio a filo



FM-71-3200
universal
12 cm/4 3/4"



toothed



FM-71-3201 TC
universal
12 cm/4 3/4"

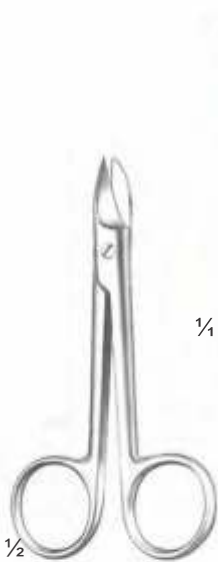

Beebee
10.5 cm/4 1/8"

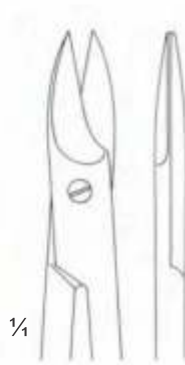

FM-71-3202
B-002-10 TC

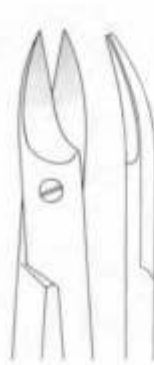

FM-71-3203
B-003-10 TC

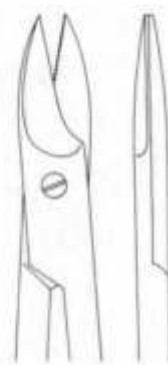

FM-71-3204
B-004-10 TC



FM-71-3205
B-005-10 TC

one toothed cutting edge



Beebee
10.5 cm/4 1/8"



Operating scissors **EN**
 Chirurgische scheren **DE**
 Tijeras quirúrgicas **ES**
 Ciseaux de fonctionnement **FR**
 Forbici funzionanti **IT**

71



SCISSORS

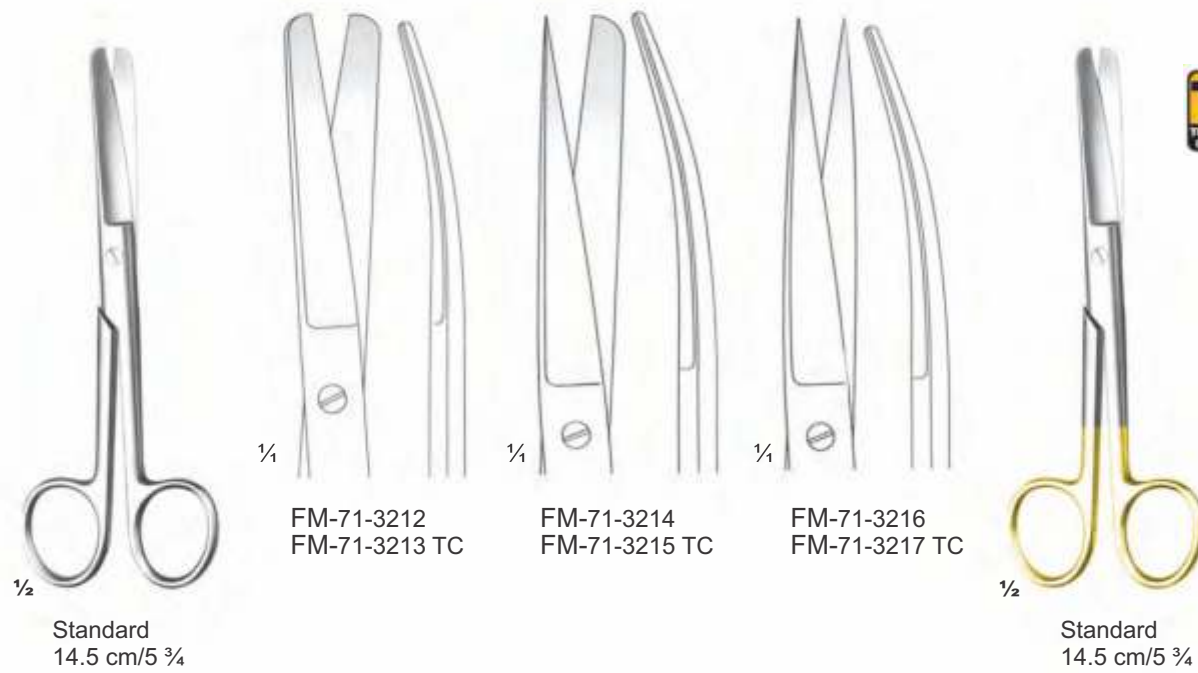
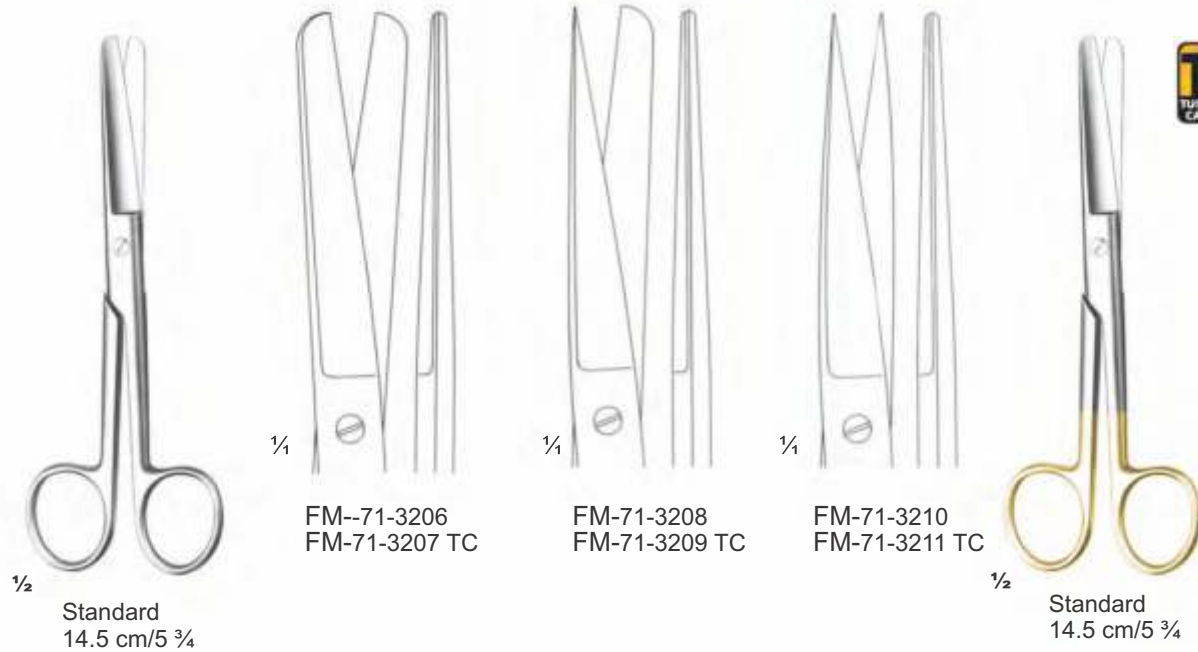

EN	Operating scissors
DE	Chirurgische scheren
ES	Tijeras quirúrgicas
FR	Ciseaux de fonctionnement
IT	Forbici funzionanti

DELICATE

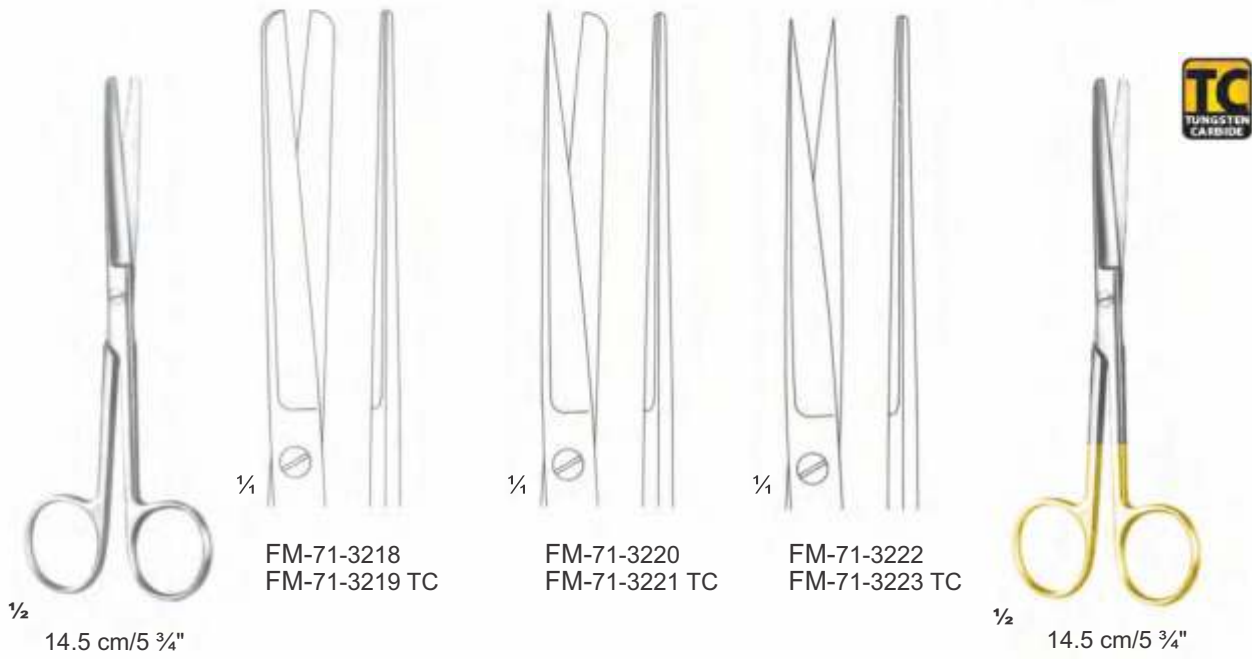

1/2 14.5 cm/5 3/4"

1/4 FM-71-3218
FM-71-3219 TC

1/4 FM-71-3220
FM-71-3221 TC

1/4 FM-71-3222
FM-71-3223 TC

1/2 14.5 cm/5 3/4"

TC
TUNGSTEN
CARBIDE

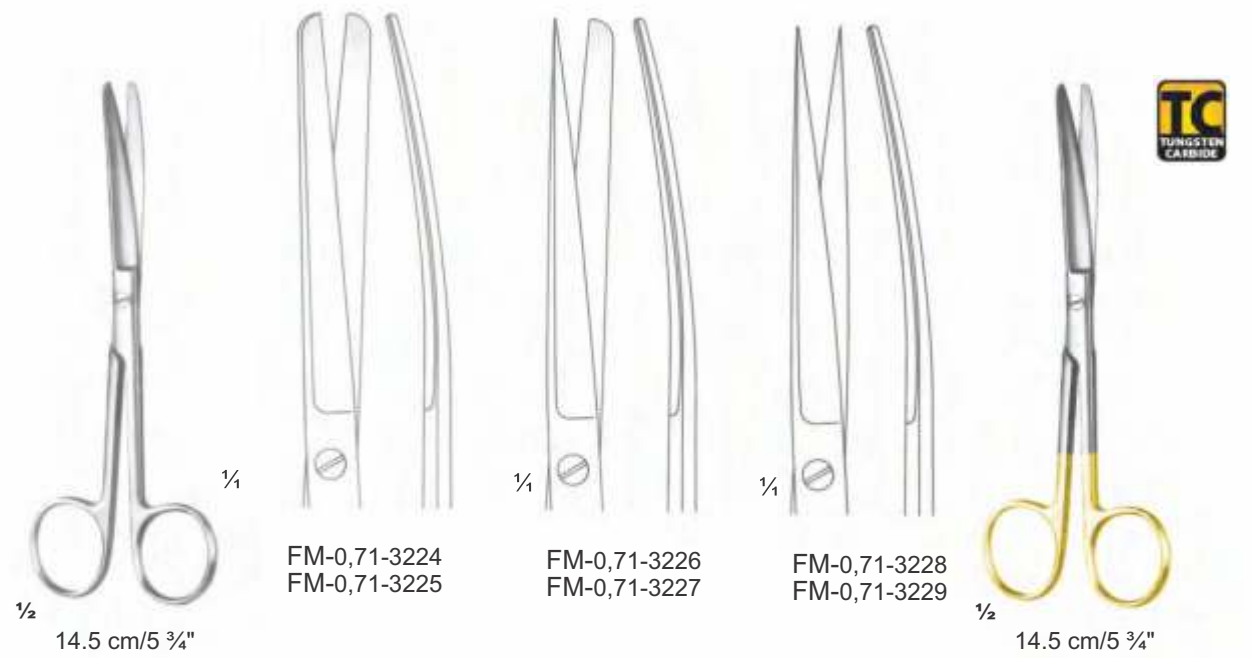

1/2 14.5 cm/5 3/4"

1/4 FM-0,71-3224
FM-0,71-3225

1/4 FM-0,71-3226
FM-0,71-3227

1/4 FM-0,71-3228
FM-0,71-3229

1/2 14.5 cm/5 3/4"

TC
TUNGSTEN
CARBIDE

Operating scissors **EN**
 Chirurgische scheren **DE**
 Tijeras quirúrgicas **ES**
 Ciseaux de fonctionnement **FR**
 Forbici funzionanti **IT**

71



SCISSORS

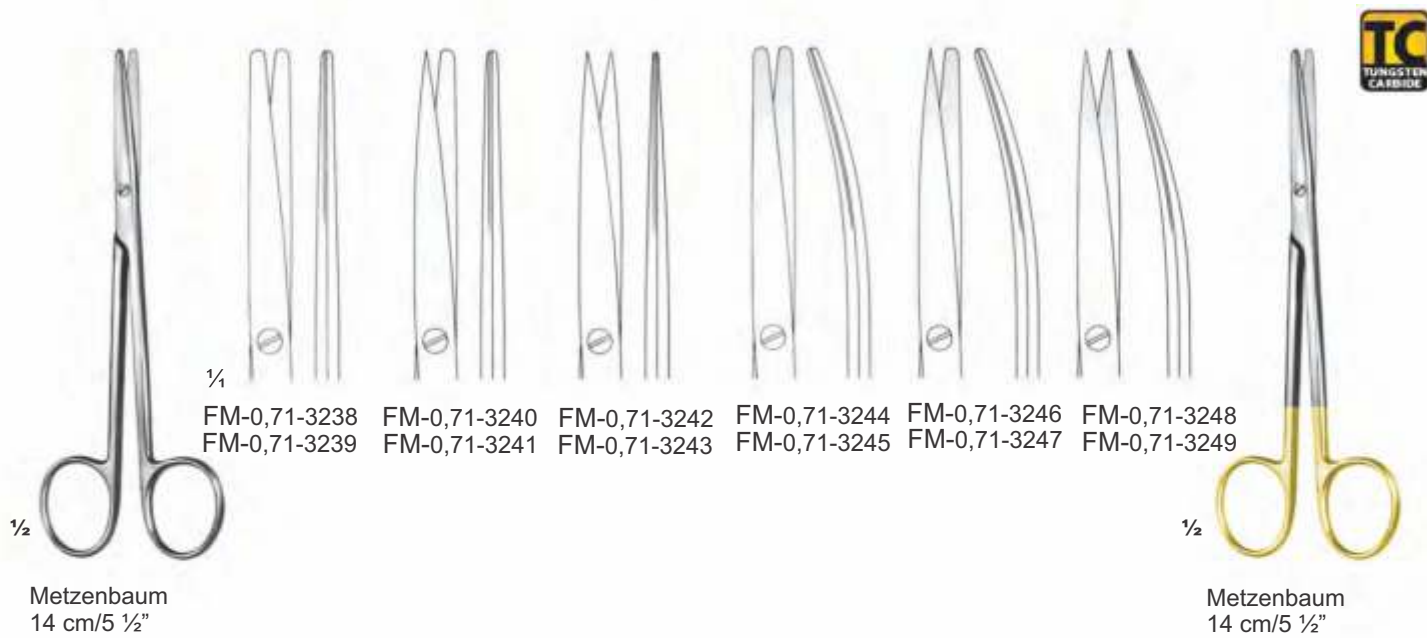

EN	Dissecting scissors
DE	Präparierscheren
ES	Tijeras de disección
FR	Ciseaux à dissection
IT	Forbici da dissezione



DELICATE



Metzenbaum
15.5 cm/6"

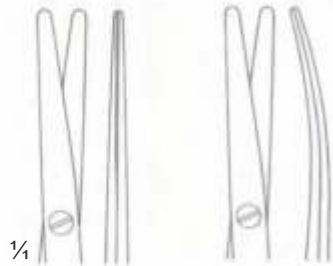

FM-0,71-3250 FM-0,71-3252
FM-0,71-3251 FM-0,71-3253



Metzenbaum
15.5 cm/6"



Metzenbaum-Nelson
18 cm/7"

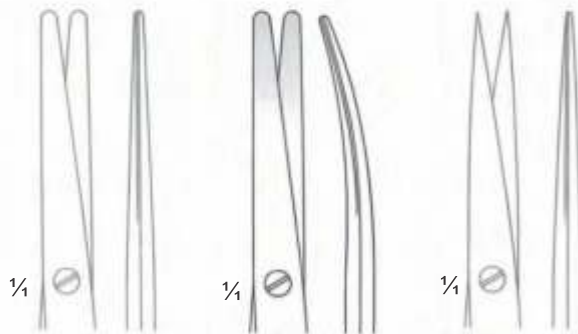

FM-0,71-3254 FM-0,71-3256 FM-0,71-3258
FM-0,71-3255 FM-0,71-3257 FM-0,71-3259



Metzenbaum-Nelson
18 cm/7"



Dissecting scissors	EN
Präparierscheren	DE
Tijeras de disección	ES
Ciseaux à dissection	FR
Forbici da dissezione	IT

71

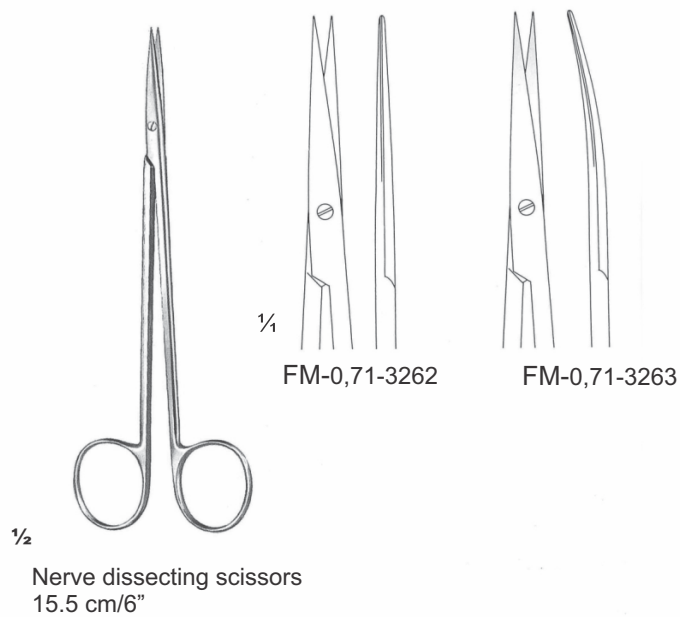
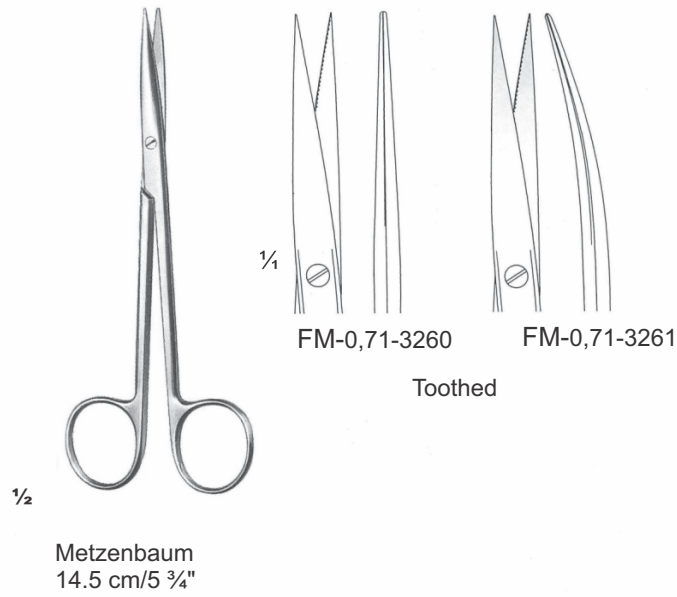

EN	Delicate dissecting scissors
DE	Feine präparierscheren
ES	Tijeras nas de disección
FR	Ciseaux de dissection délicats
IT	Delicate forbici da dissezione



SCISSORS

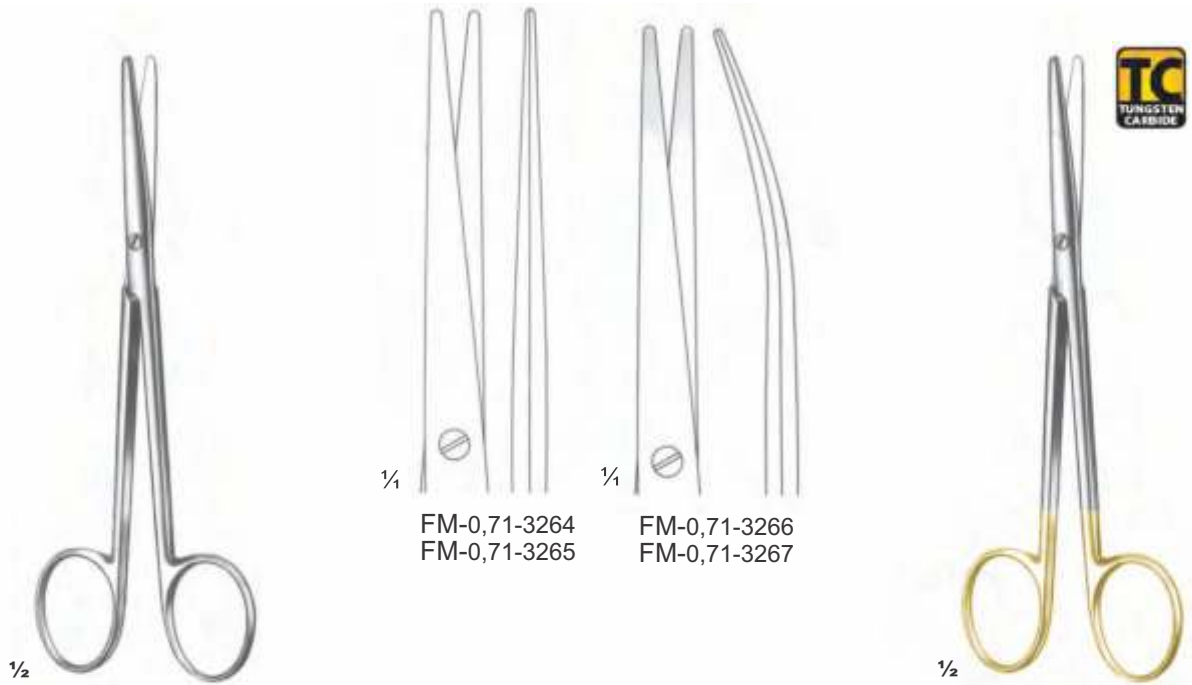

Lexer-Fino slender pattern
16.5 cm/6 1/2"

Lexer-Fino slender pattern
16.5 cm/6 1/2"

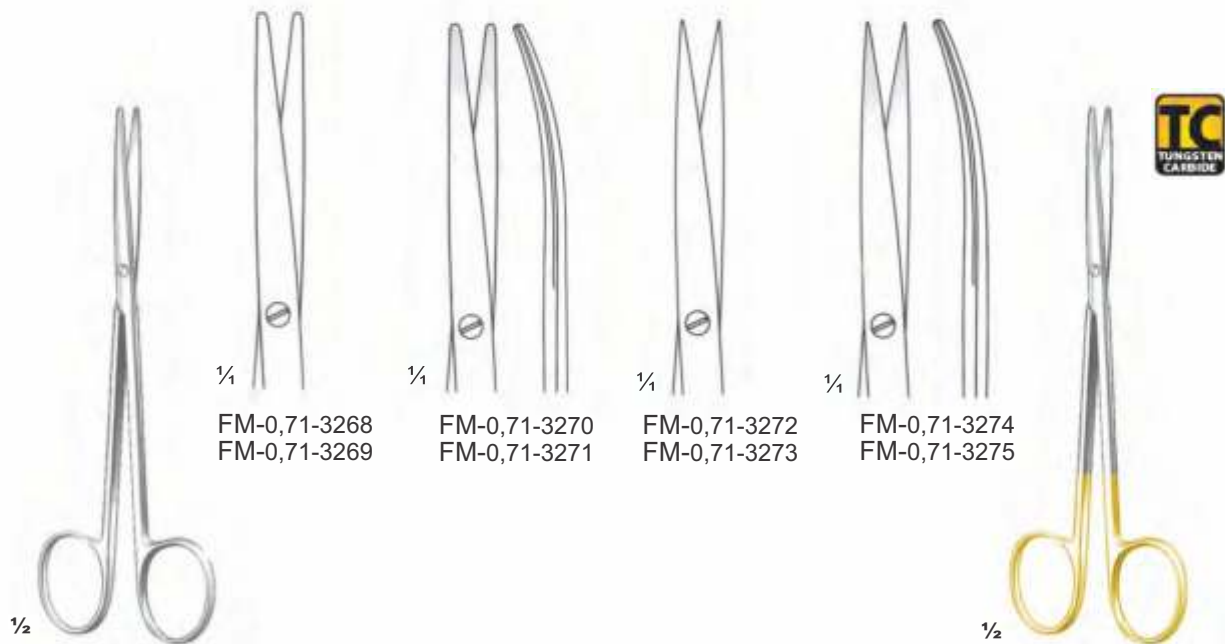

Metzenbaum-Fino slender pattern
14.5 cm/5 3/4"

Metzenbaum-Fino slender pattern
14.5 cm/5 3/4"

Delicate dissecting scissors EN

Feine präparierscheren DE

Tijeras nas de disección ES

Ciseaux de dissection délicats FR

Delicate forbici da dissezione IT

71



SCISSORS



Metzenbaum-Fino slender pattern 18 cm/7"



FM-0,71-3276 FM-0,71-3277

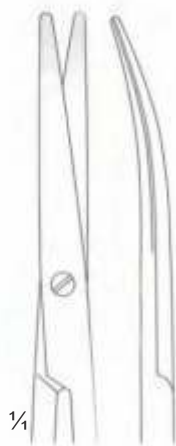

FM-0,71-3278 FM-0,71-3279



Metzenbaum-Fino slender pattern 18 cm/7"



Metzenbaum-Fino S shaped 18 cm/7"



FM-0,71-3280 FM-0,71-3281



Metzenbaum-Fino S shaped 18 cm/7"



FM-0,71-3282 12.5 cm/5"



Salzer model for cleft palate



FM-0,71-3283 18 cm/7"

EN Gum scissors, dissecting scissors, operating scissors
DE Zahn eischscheren, präparierscheren, chirurgische scheren
ES Tijeras para encias, Tijeras de disección, Tijeras quirúrgicas
FR Ciseaux de gomme, ciseaux de dissection, ciseaux de fonctionnement
IT Forbici da masticare, forbici da dissezione, forbici funzionanti



SCISSORS

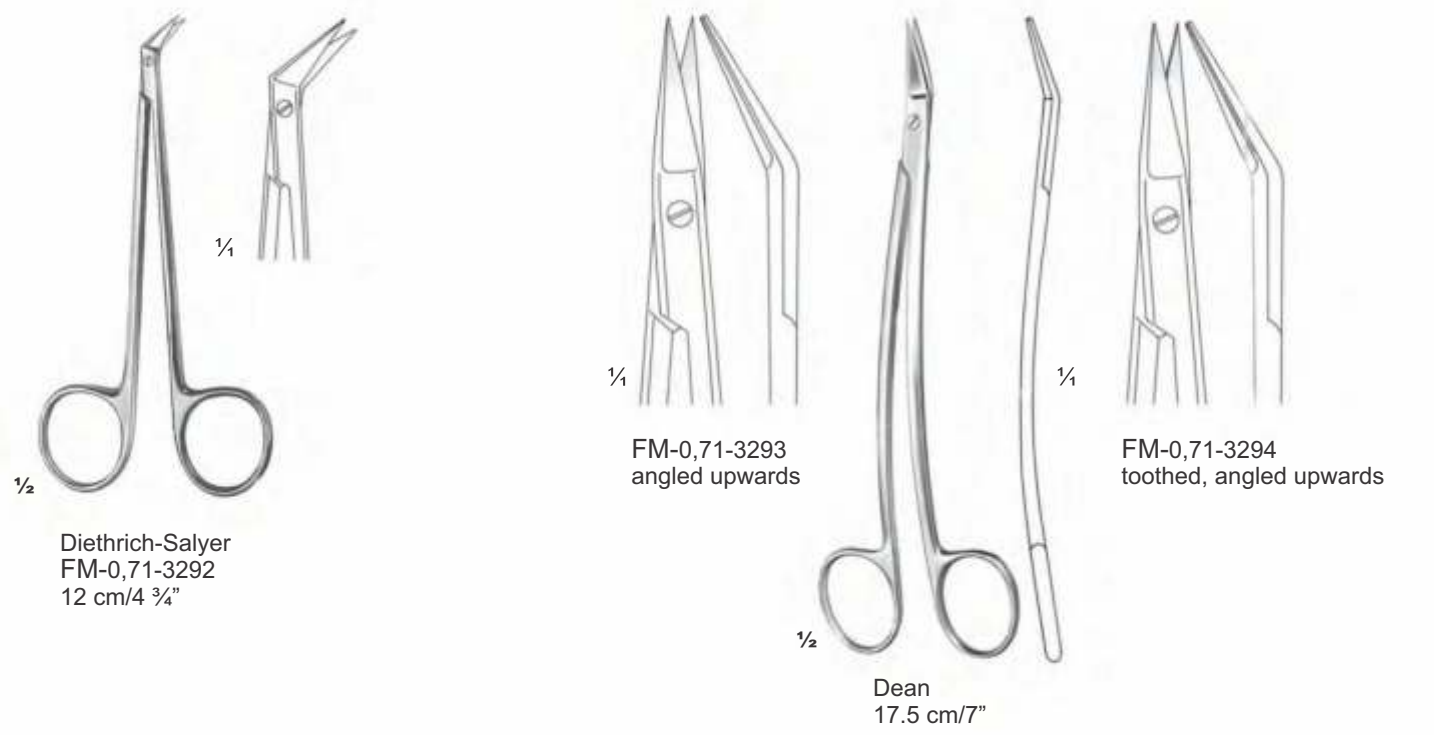

Gum scissors, operating scissors **EN**
 Zahn eischscheren, chirurgische scheren **DE**
 Tijeras para encías, Tijeras quirúrgicas **ES**
 Ciseaux de gomme, ciseaux de fonctionnement **FR**
 Forbici da masticare, forbici funzionanti **IT**

71



SCISSORS



FM-0,71-3295 FM-0,71-3297
 FM-0,71-3296 FM-0,71-3298

GOLDMANN-FOX
 13 cm/5 1/8"

GOLDMANN-FOX
 13 cm/5 1/8"



FM-0,71-3299 FM-0,71-3301
 FM-0,71-3300 FM-0,71-3302

Toothed Blades

GOLDMANN-FOX
 13 cm/5 1/8"

GOLDMANN-FOX
 13 cm/5 1/8"



FM-0,71-3303 FM-0,71-3304 FM-0,71-3305

Small modle
 12 cm/4 3/4"



slender pattern
 FM-0,71-3306
 FM-0,71-3307

Toennis-Adson
 17.5 cm/7"

Toennis-Adson
 17.5 cm/7"

EN Gum scissors, operating scissors
 DE Zahn eischscheren, chirurgische scheren
 ES Tijeras para encías, Tijeras quirúrgicas
 FR Ciseaux de gomme, ciseaux de fonctionnement
 IT Forbici da masticare, forbici funzionanti



SCISSORS

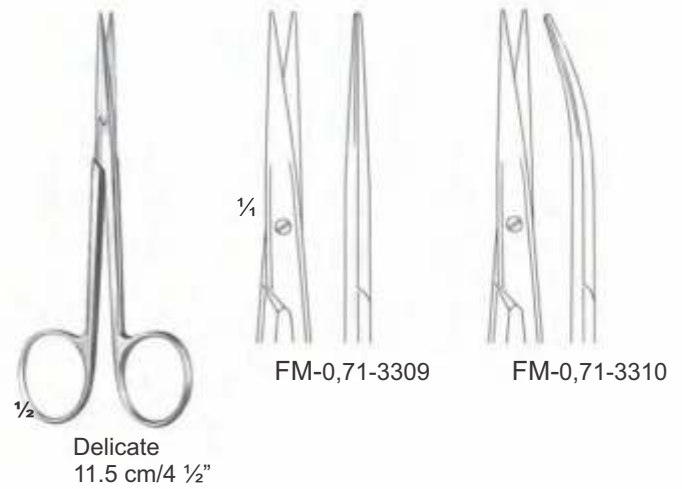

Iris scissors EN

Irisscheren DE

Tijeras para iridectomía ES

Ciseaux à iris FR

Forbici Iris IT

71



SCISSORS



EN Iris Scissors, tendon scissors
DE Irisscheren, Sehenscheren
ES Tijeras para iridectomía, tijeras para tendones
FR Ciseaux d'iris, ciseaux de tendon
IT Iris Scissors, forbici tendine



SCISSORS



11.5 cm/4 1/2"

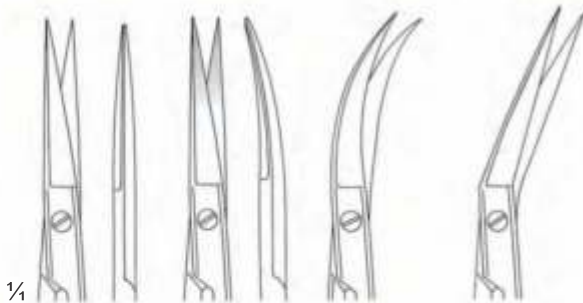

FM-0,71-3328 FM-0,71-3330 FM-0,71-3332 FM-0,71-3334
 FM-0,71-3329 FM-0,71-3331 FM-0,71-3333 FM-0,71-3335



11.5 cm/4 1/2"

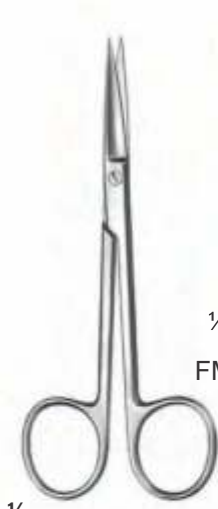

12.5 cm/5"

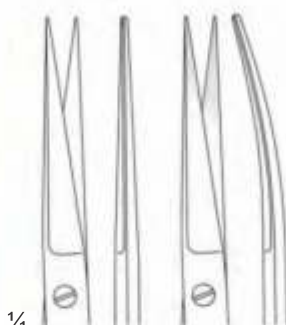

FM-0,71-3336 FM-0,71-3337



Stevens
 11 cm/4 1/2"

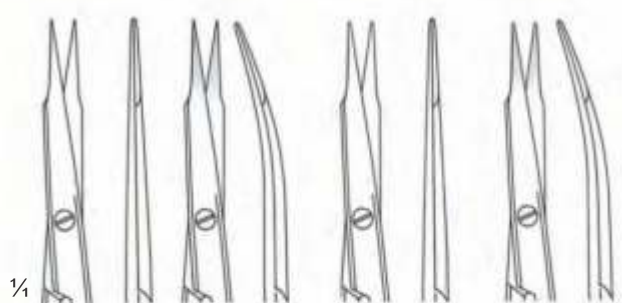

FM-0,71-3338 FM-0,71-3339 FM-0,71-3340 FM-0,71-3341
 sharp sharp blunt blunt

Stitch scissors	EN
Fadenscheren	DE
Tijeras para hilos	ES
Ciseaux de couture	FR
Forbici da punto	IT

71



SCISSORS

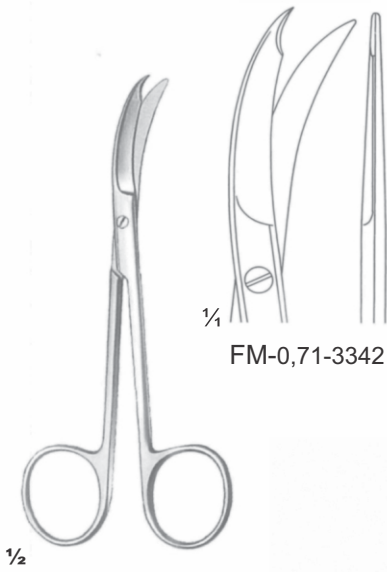

1/4 FM-0,71-3342

1/2

Northbent
13 cm/5"



1/4 FM-0,71-3343 9 cm/3 1/2"
1/4 FM-0,71-3344 13 cm/5"

1/2

Spencer

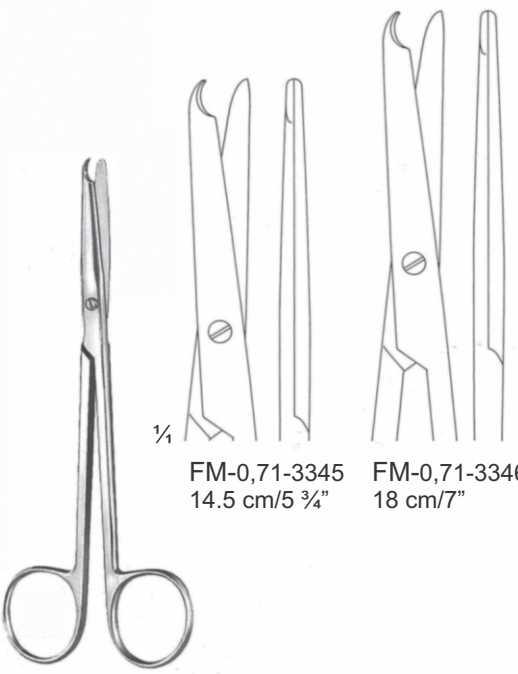

1/4 FM-0,71-3345 14.5 cm/5 3/4"
1/4 FM-0,71-3346 18 cm/7"

1/2

Buck

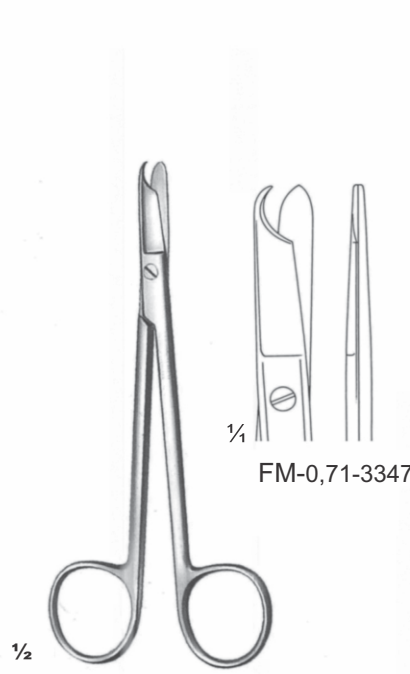

1/4 FM-0,71-3347

1/2

Littauer
14 cm/5 1/2"



1/4 FM-0,71-3348

1/2

Eiselsberg
12 cm/4 3/4"

EN	Bandage scissors
DE	Verbandscheren
ES	Tijeras para vendajes
FR	Ciseaux de pansement
IT	Forbici per bende

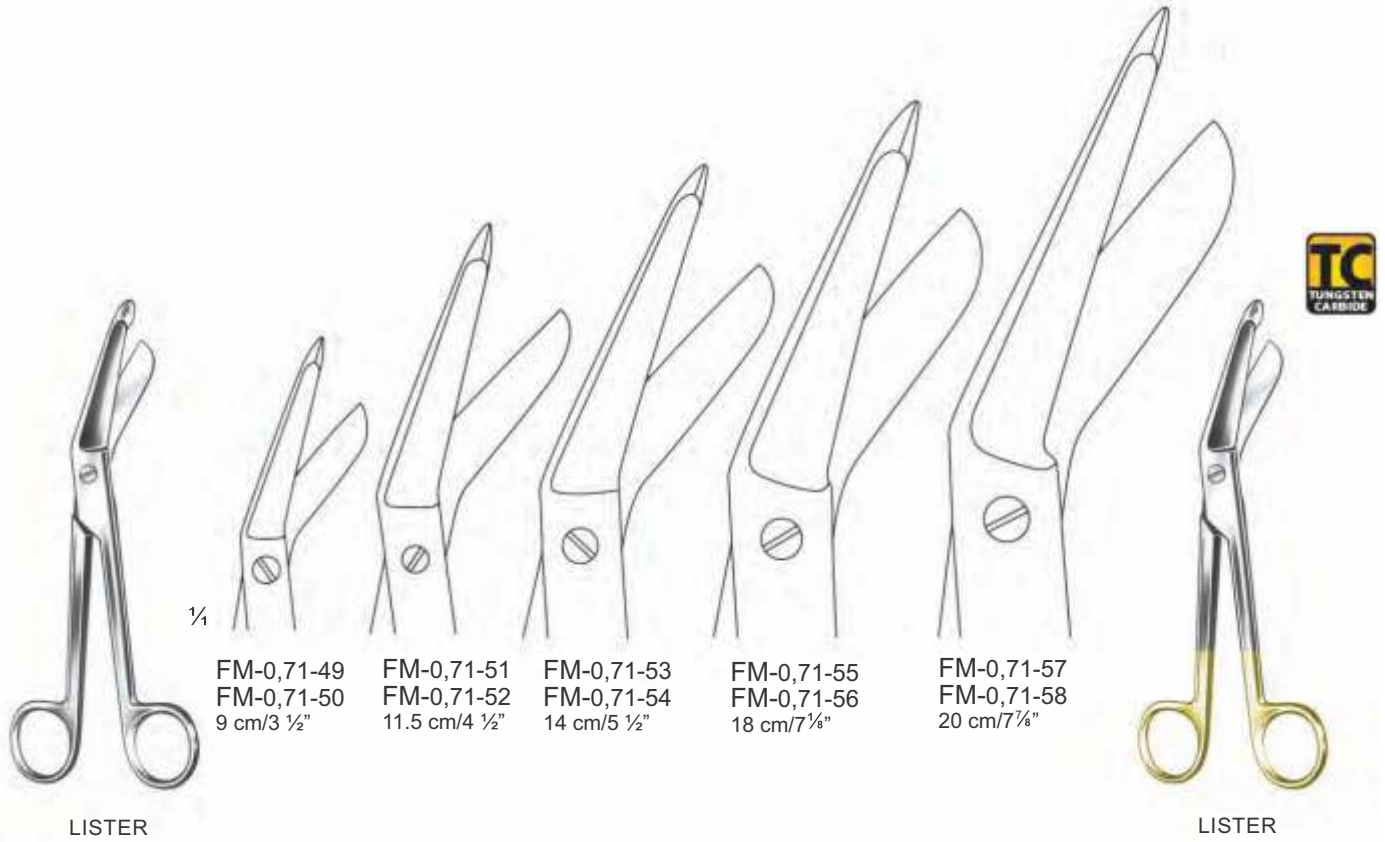

Delicate dissecting scissors EN

Feine präparierscheren DE

Tijeras nas de disección ES

Ciseaux de dissection délicats FR

Delicate forbici da dissezione IT

71



1/2
Metzenbaum-Lahey
slender pattern

1/4
FM-71-3363
14.5 cm/5 3/4"
slender pattern

1/2
Metzenbaum-Fino
slender pattern

1/4
FM-71-3364
20.5 cm/8"

FM-71-3365
23 cm/9"

EN	Gum scissors
DE	Zahn esischeren
ES	Tijeras para encías
FR	Ciseaux de gomme
IT	Forbici da masticare

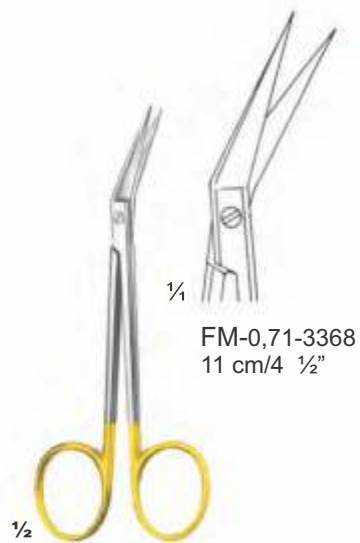
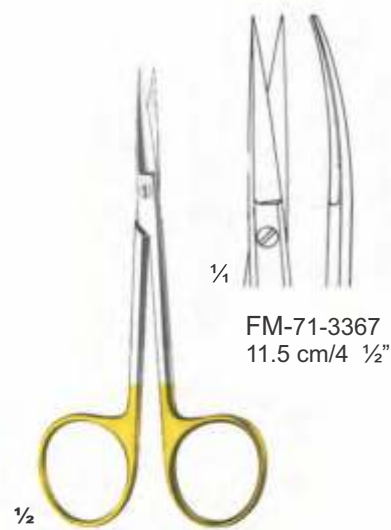
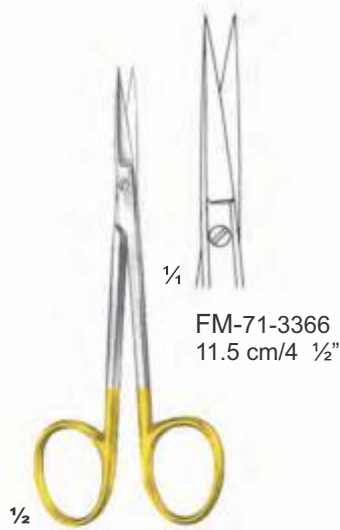

Ragnell

Gum scissors	EN
Zahn esischeren	DE
Tijeras para encías	ES
Ciseaux de gomme	FR
Forbici da masticare	IT

71



SCISSORS

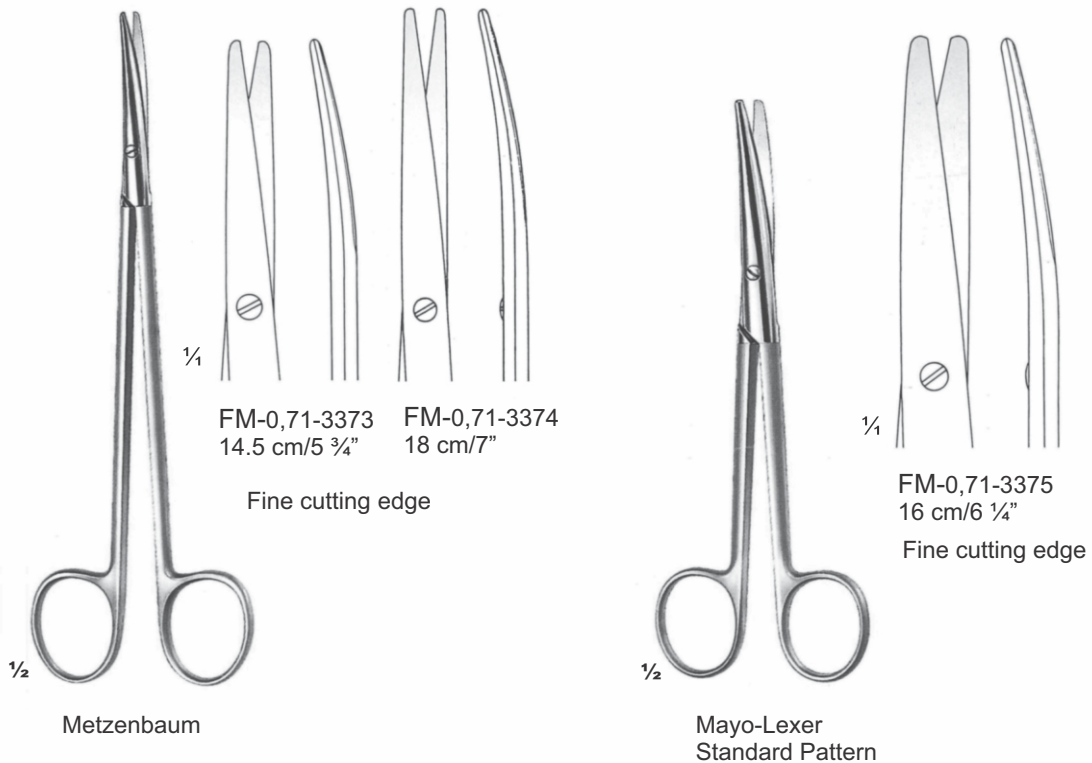
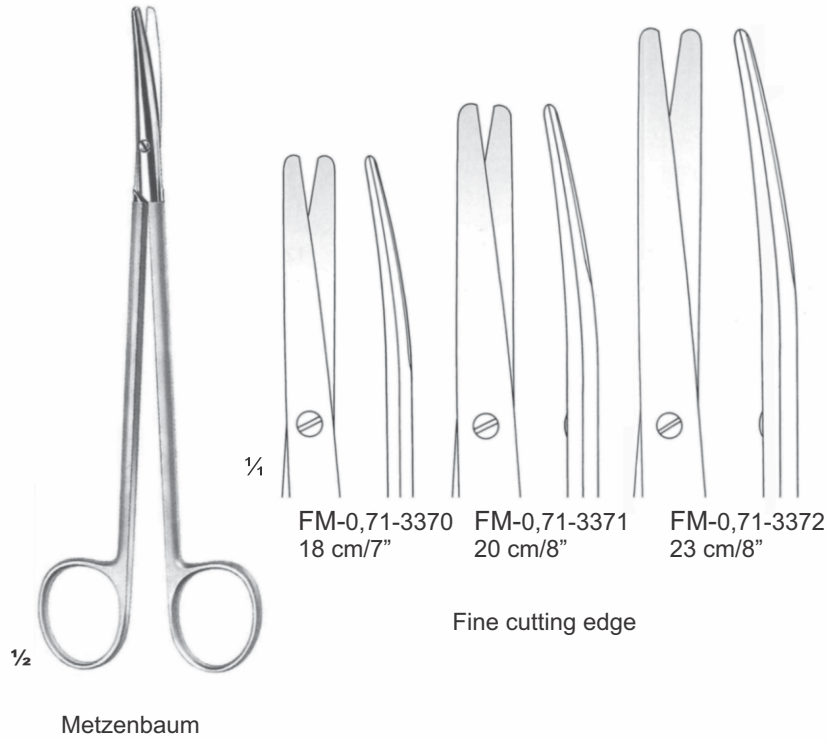

EN	Ligature scissors
DE	Ligaturscheren
ES	Tijeras para lagaduras
FR	Ciseaux à ligatures
IT	Forbici per legature



SCISSORS

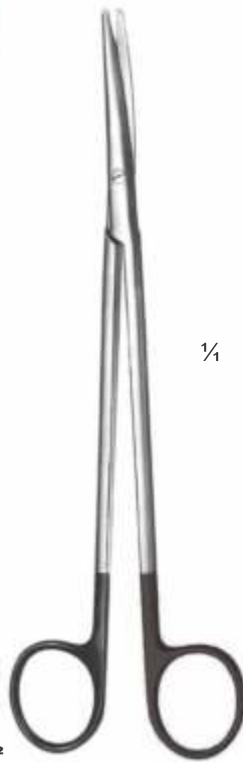

¼



FM-0,71-3376
14.5 cm/5 ¾"



FM-0,71-3377
18 cm/7"

For synthetic suture material
One toothed cutting edge

½



¼



FM-0,71-3378
14.5 cm/5 ¾"

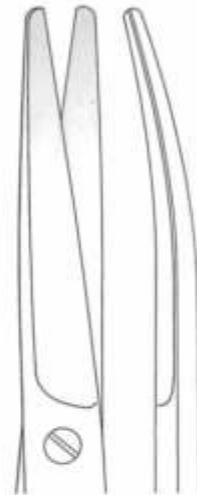

FM-0,71-3379
17 cm/6 ¾"

For synthetic suture material
One toothed cutting edge

½

EN	Micro Scissors
DE	Mikroschere
ES	Micro tijeras
FR	Micro-ciseaux
IT	Micro forbici

Page 172 to 173



EN	Micro Scissors
DE	Mikroscheren
ES	Micro-ciseaux
FR	Tijeras microquirúrgicas
IT	Forbici micro-chirurgici



JMCRO SCISSORS

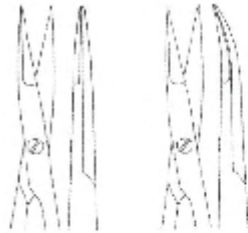

15 cm/6"	FM-0,72-3401	FM-0,72-3405
18 cm/7"	FM-0,72-3402	FM-0,72-3406
21 cm/8 1/4"	FM-0,72-3403	FM-0,72-3407
23 cm/9"	FM-0,72-3404	FM-0,72-3408



Streamlined

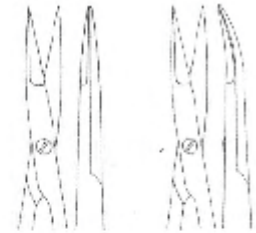

15 cm/6"	FM-0,72-3409	FM-0,72-3413
18 cm/7"	FM-0,72-3410	FM-0,72-3414
21 cm/8 1/4"	FM-0,72-3411	FM-0,72-3415
23 cm/9"	FM-0,72-3412	FM-0,72-3416



Streamlined

Micro Scissors **EN**

Mikroscheren **DE**

Micro-ciseaux **ES**

Tijeras microquirúrgicas **FR**

Forbici micro-chirurgici **IT**

72



JMCRQ SCISSORS



NOYES
FM-0,72-3417
13 cm/5"

EN	Orthodontics
DE	Kieferorthopädie
ES	Ortodoncia
FR	Orthodontie
IT	Ortodonzia

Page 174 to 190



EN	Flat nose pliers
DE	Rund-, Flachzange
ES	Pinces plates, rondes
FR	Alicates de pico plano
IT	Tenaglie piatte



FAIZAN & MUSA
SURGICAL



5 mm
textured

FM-0,73-3501
14 cm/5 1/2"



LANGENBECK
FM-0,73-3502
15 cm/6"



narrow, serrated

FM-0,73-3503
14 cm/5 1/2"



smooth

FM-0,73-3504
12,5 cm/4 3/4"



serrated

FM-0,73-3505
13 cm/5"



serrated

FM-0,73-3506
14 cm/5 1/2"



FAIZAN & MUSA
SURGICAL

Flat nose pliers, Wire bending pliers	EN
Rund-, Flachzange, Drahtbiegezange	DE
Pinces plates, rondes, Pince pour technique	ES
Alicates de pico plano, Alicates para doblar alambres	FR
Renaglie piate, Pinza tecnica per lo	IT



Contouring pliers

GOSLEE
FM-0,73-3507
14 cm/5 1/2"



Contouring pliers

GOSLEE
FM-0,73-3508
14 cm/5 1/2"



Contouring pliers

GOSLEE
FM-0,73-3509
14 cm/5 1/2"



serrated

FM-0,73-3510
12,5 cm/4 3/4"



round

Flat

FM-0,73-3511
15 cm/6"



round
nose pliers

FM-0,73-3512
13 cm/5"

EN	Flat and round nose pliers
DE	Flach-und Rundzangen
ES	Pinces á mors plats et ronds
FR	Alicates de picos planos y redondos
IT	Tenaglie a punte piatte e rotondo



FAIZAN & MUSA
SURGICAL



FM-0,73-3513
13 cm/5"



FM-0,73-3514
13 cm/5"



LANGENBECK
FM-0,73-3515
14 cm/5 1/2"



DUMONT
FM-0,73-3516
11,5 cm/4 1/2"



DUMONT
FM-0,73-3517
11,5 cm/4 1/2"



DUMONT
FM-0,73-3518
11,5 cm/4 1/2"

Wire cutter, front action



FM-0,73-3519
11 cm/4 1/4"



FM-0,73-3520
11,5 cm/4 1/2"



FM-0,73-3521
12,5 cm/4 3/4"



FM-0,73-3522
11,5 cm/4 1/2"



FM-0,73-3523
11,5 cm/4 1/2"

0,7 mmØ
for hard wire up to

EN	Wire Bending Pliers
DE	Drahtbiegezangen
ES	Alicates para doblar alambre
FR	Pinces pour plier l d'acier
IT	Pinze piega lp



FAIZAN & MUSA
SURGICAL



1,0 mm Ø
for hard wire up to

FM-0,73-3524
15 cm/6"



SCHWARZ
FM-0,73-3525
13 cm/5"
Modell I



SCHWARZ
FM-0,73-3526
13 cm/5"
Modell II



SCHWARZ
FM-0,73-3527
13 cm/5"
Modell III



SCHWARZ
FM-0,73-3528
14,5 cm/5 3/4"



FISCHER
FM-0,73-3529
14 cm/5 1/2"



Wire Bending Pliers **EN**

Drahtbiegezaugen **DE**

Alicates para doblar alambre **ES**

Pinces pour plier l'acier **FR**

Pinze piega lp **IT**

73



FAIZAN & MUSA
SURGICAL

ORTHODONTICS



ANDRESEN
FM-0,73-3530
13,5 cm/5 1/2"



STADLER
FM-0,73-3533
15 cm/6"



sling forming pliers

McKELLOPS
FM-0,73-3531
17 cm/6 3/4"

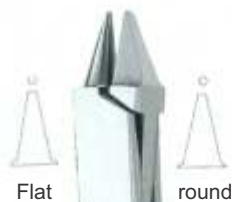

Flat round



McKELLOPS-
STADLER
FM-0,73-3532
16 cm/6 1/4"

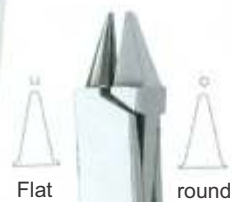

Flat round



ANGLE
FM-0,73-3534
12,5 cm/5"



ANGLE
FM-0,73-3535
12,5 cm/5"



- EN Wire Bending Pliers, Loop forming pliers
- DE Drahtbiegeezangen, Schlaufenbiegeezangen
- ES Alicates para doblar alambre, Alicates para pliegues
- FR Pincés pour plier l'acier, pincés à façonner
- IT Pinzo piega filo, pinze per pieghe



FAIZAN & MUSA
SURGICAL

ORTHODONTICS



ADAMS
FM-0,73-3536
13 cm/5"



YOUNG
FM-0,73-3537
13 cm/5"



TWEED
FM-0,73-3538
13,5 cm/5 1/2"



TWEED
FM-0,73-3539
13,5 cm/5 1/2"



DE LA ROSA
FM-0,73-3540
12,5 cm/5"

Contouring pliers



DE LA ROSA
FM-0,73-3541
12,5 cm/5"

Wire, arch and clasp bending pliers **EN**
 Draht-, Bogen- und Klammernbiegezeugen **DE**
 Pincas à courber les fils, les branches et les agrafes **ES**
 Alicates para doblar alambres, arcos y ganchos **FR**
 Tenaglie per la piegatura di fili metallici, staffe graffe **IT**

73



FAIZAN & MUSA
SURGICAL

ORTHODONTICS

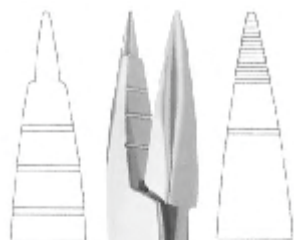

ovalen Draht bis
hart 1,5 x 0,75 mm

0,7 mm Ø
hard wire up to

oval wire up to
1.5 x 0.75 mm



JARABAK
FM-0,73-3542
14 cm/5 1/2"



ADERER
FM-0,73-3543
14 cm/5 1/2"



KOEHLER
FM-0,73-3544
12 cm/4 3/4"



FM-0,73-3545
14 cm/5 1/2"

0,7 mm Ø
for hard wire up to

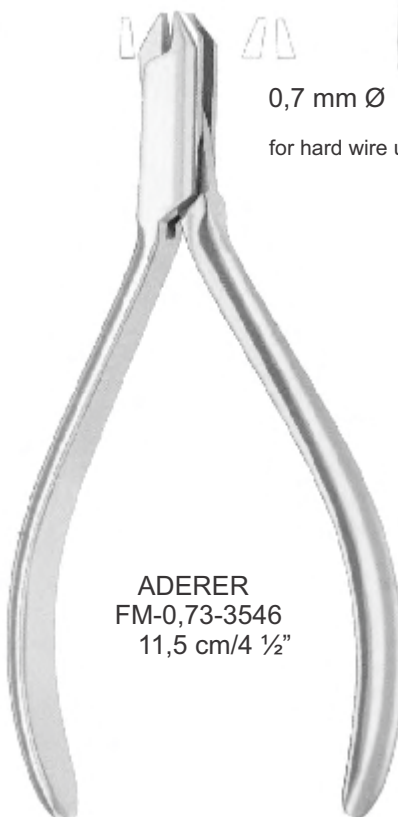

ADERER
FM-0,73-3546
11,5 cm/4 1/2"

0,7 mm Ø
for hard wire up to



ADERER
FM-0,73-3547
12,5 cm/5"

0,9 mm Ø
for hard wire up to

- EN Universal pliers, bridge removing pliers
 DE Universal-Kramponzange, Bruckenabnehmezangen
 ES Pincas universelles, pincas d' extraction de bridge
 FR Alicates universales, alicates para puentes
 IT Tenaglie universali, tanaglie pone di ponticeller la rimozii



FAIZAN & MUSA
SURGICAL

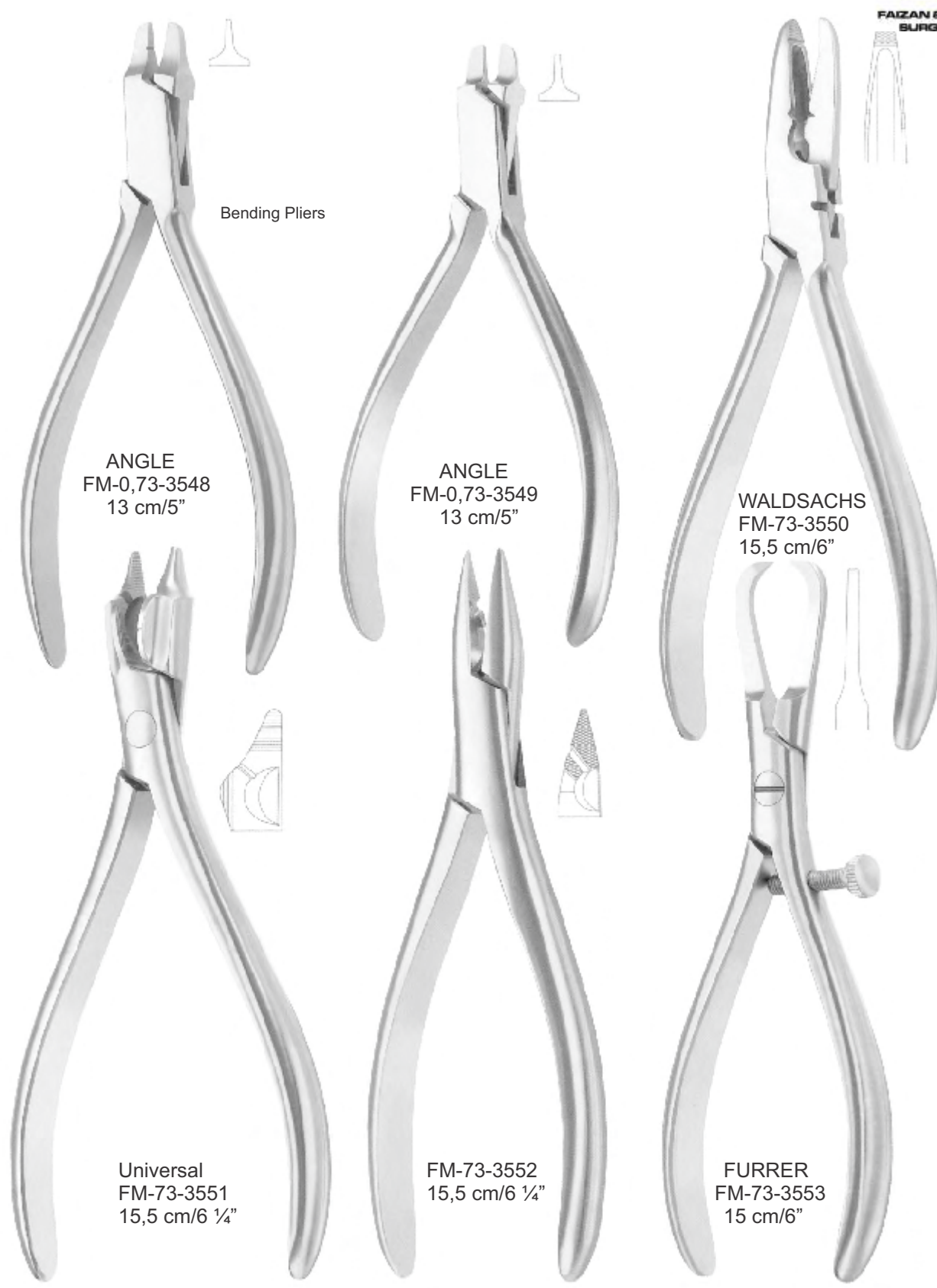

Bending Pliers

ANGLE
FM-0,73-3548
13 cm/5"

ANGLE
FM-0,73-3549
13 cm/5"

WALDSACHS
FM-73-3550
15,5 cm/6"

Universal
FM-73-3551
15,5 cm/6 ¼"

FM-73-3552
15,5 cm/6 ¼"

FURRER
FM-73-3553
15 cm/6"

Crown instruments **EN**
 Kroneinstrumente **DE**
 Instruments à couronnes **ES**
 Strumenti per corone **FR**
 Instrumentos para coronas **IT**

73



**FAIZAN & MUSA
 SURGICAL**

ORTHODONTICS

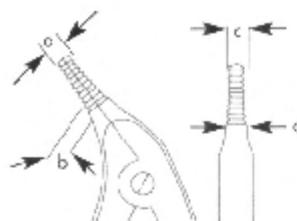

a	b	c	d
3,3	4	2,3	3,0
4,4	5	3,4	3,8

Telescope crown pliers



BOEHM
FM-73-3554
 12 cm/4 3/4"



BOEHM
FM-73-3555
 15 cm/4"

EN	Band removing pliers
DE	Bandabnehmezangen
ES	Alicatas para quitar bandas
FR	Pince à enlever les bagues
IT	Pinze asportabande



OLIVER
JONES
FM-73-3556
15 cm/6"



OLIVER
FM-73-3557
15 cm/6"



OLIVER
FM-73-3558
15 cm/6"

Step loop bending pliers



ADERER
FM-73-3559
13,5 cm/5 ¼"



NANCE
FM-73-3560
12,5 cm/5"

Ligature pliers, Ligature cutter **EN**
 Ligaturzangen, Ligatur-Schneider **DE**
 Pincas á ligature, ligature coupantes **ES**
 Alicates para ligaduras, ligaduras cortar **FR**
 Tenaglie per legature, legature taglia li **IT**

73



FAIZAN & MUSA
 SURGICAL

ORTHODONTICS



0,7 mm Ø

for hard wire up to



- EN Contouring pliers, Crown pliers
- DE Konturzangen, Kronenzangen
- ES Pincas á coronne, pincas de contours
- FR Alicates para coronas y para contornear
- IT Tenaglie per corone, tenaglie per pro li



TRYFUS
FM-73-3567
16 cm/6 1/4"

Crown stretching pliers



smooth



PEESO
FM-73-3568
12 cm/6 1/4"



serrated



PEESO
FM-73-3569
13,5 cm/5 1/4"



straight



PEESO
FM-73-3570
14 cm/5 1/2"



curved



HOW
FM-73-3571
14 cm/5 1/2"



HOW
FM-73-3572
14 cm/5 1/2"

Instruments for crown work **EN**
Kroneninstrumente **DE**
Instruments de couronnes **ES**
Instrumentos para coronas **FR**
Strumenti per corone **IT**

73



FM-73-3573
18 cm/7"



curved



FM-73-3574
14,5 cm/5 3/4"

ORTHODONTICS

EN	Contouring pliers
DE	Konturzangen
ES	Pinces a couronne
FR	Alicates para contornear
IT	Tenaglie per corone



FREVERT
FM-73-3575
12 cm/4 3/4"



TRIPLEX
FM-73-3576
14 cm/5 1/2"



REYNOLD
FM-73-3577
12 cm/4 3/4"



GORDON
FM-73-3578
13,5 cm/5 1/4"



JOHNSON
FM-73-3579
13 cm/5"

Bracket Positioning Forceps EN

Klebebracketpinzetten DE

Pince pour le positionnement de bracket ES

Pinza para posicionamiento de bracket FR

Pinza per il posizionamento staffa IT

73



Clamping tweezer / bracket holder

ORTHODONTICS



FM-73-3580 FM-73-3581 FM-73-3582 FM-73-3583 FM-73-3584 FM-73-3585 FM-73-3586 FM-73-3588 FM-73-3587 FM-73-3589
Bracket P. Gauge Band Remover Band Remover

Bracket positioning gauge



FM-73-3590

EN	Orthodontic Forceps
DE	Kieferorthopädische Pinzetten
ES	Pinzas de ortodoncia
FR	Forceps orthodontiques
IT	Forcipe ortodontico



FAIZAN & MUSA
SURGICAL



FM-73-3591
12.5 cm/5"



FM-73-3592
12.5 cm/5"



FM-73-3593
12.5 cm/5"



FM-73-3594
12.5 cm/5"



FM-73-3595
12.5 cm/5"



FM-73-3596
12.5 cm/5"



FM-73-3597
12.5 cm/5"



FM-73-3598
12.5 cm/5"



FM-73-3599
12.5 cm/5"



FM-73-3600
12.5 cm/5"



FM-73-3601
12.5 cm/5"



FM-73-3602
12.5 cm/5"

EN	Bone Rongeurs
DE	Knochen Rongeur
ES	Rongeurs de hueso
FR	Os Rongeurs
IT	Bone Rongeurs

Page 191 to 193



EN	Bone Rongeurs
DE	Knochenzange
ES	Roedores de hueso
FR	Bone Rongeur
IT	Roditori di ossa

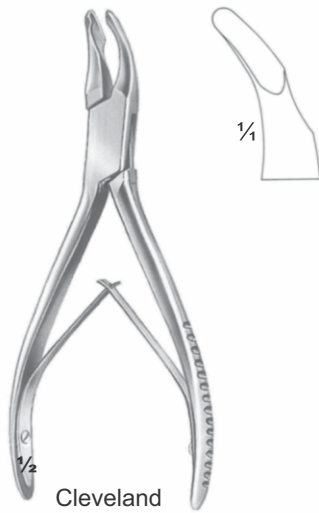

Cleveland
FM-74-3701
15 cm



Cleveland
FM-74-3702
15 cm

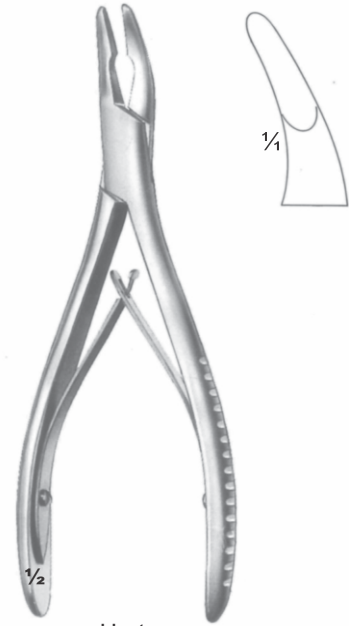

Hartmann
FM-74-3703
18 cm



LUER
15 cm

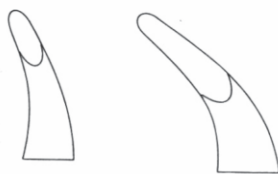

FM-74-3704 FM-74-3705



JM-74-3706



BLUMENTHAL
15 cm

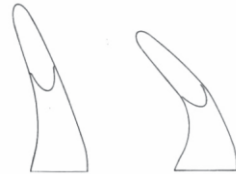

FM-74-3707 FM-74-3708
16 cm/6 1/4" 15.5 cm/6 1/8"



JM-74-3709
15.5 cm/6 1/8"

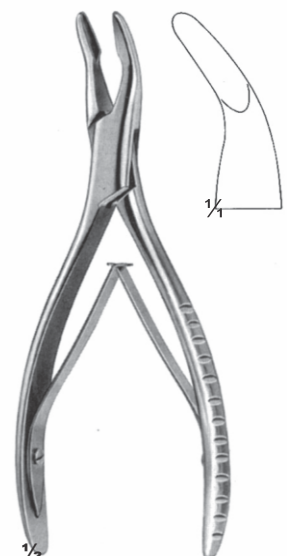

MEAD
FM-74-3710
16.5 cm/6 1/2"

Bone Rongeurs	EN
Knochenzange	DE
Roedores de hueso	ES
Bone Rongeur	FR
Roditori di ossa	IT

74



Friedmann
FM-74-3711
14 cm



Friedmann
FM-74-3712
14 cm



Friedmann-Micro
FM-74-3713
15 cm/6"
straight

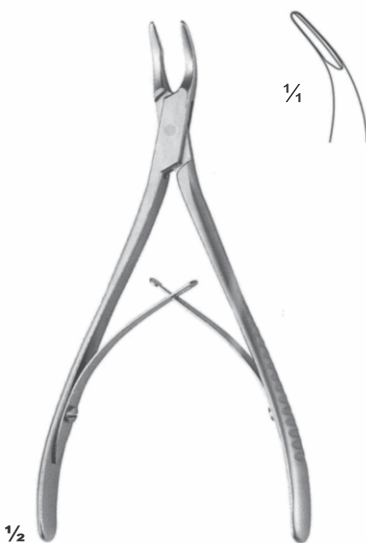

Friedmann-Micro
FM-74-3714
15 cm/6"
30°



Friedmann-Micro
FM-74-3715
14.5 cm/5 3/4"
90°

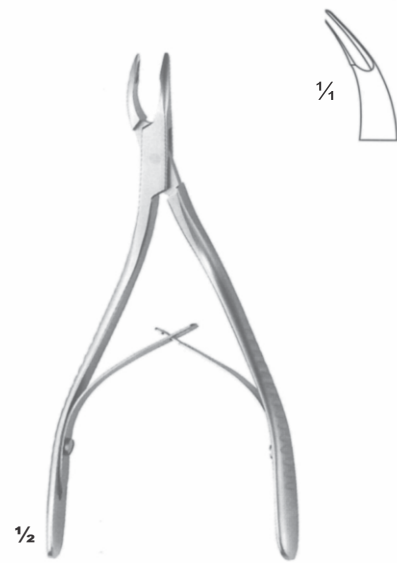

Friedmann-Micro
FM-74-3716
14.5 cm/5 3/4"
S shape
30°

EN	Bone Rongeurs
DE	Knochennaegetierte
ES	Roedores de hueso
FR	Bone Rongeur
IT	Roditori di ossa

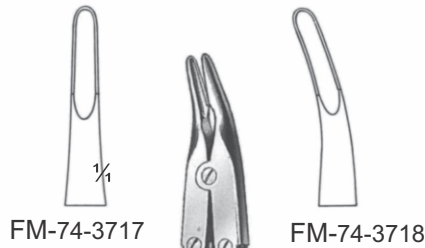

FM-74-3717

FM-74-3718

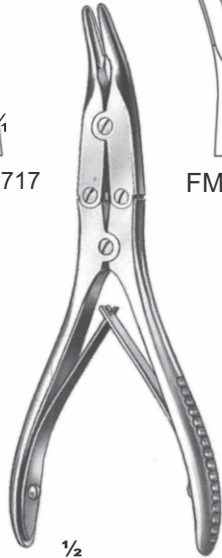

1/2
Bohler
15.5 cm/6"



1/2
Beyer
FM-74-3719
18 cm/7"



1/2 May eld
FM-74-3720
18 cm/7"



1/2 Zaufal-Jansen
FM-74-3721
18 cm/7"



1/2 Ruskin
FM-74-3722
19 cm/7 1/2"

EN	Forceps
DE	Zange
ES	Fórceps
FR	Forceps
IT	forcipe

Page 194 to 201



EN	Dressing Forceps
DE	Verbandzange
ES	Vendaje de fórceps
FR	Pince à pansement
IT	Pinze per medicazione

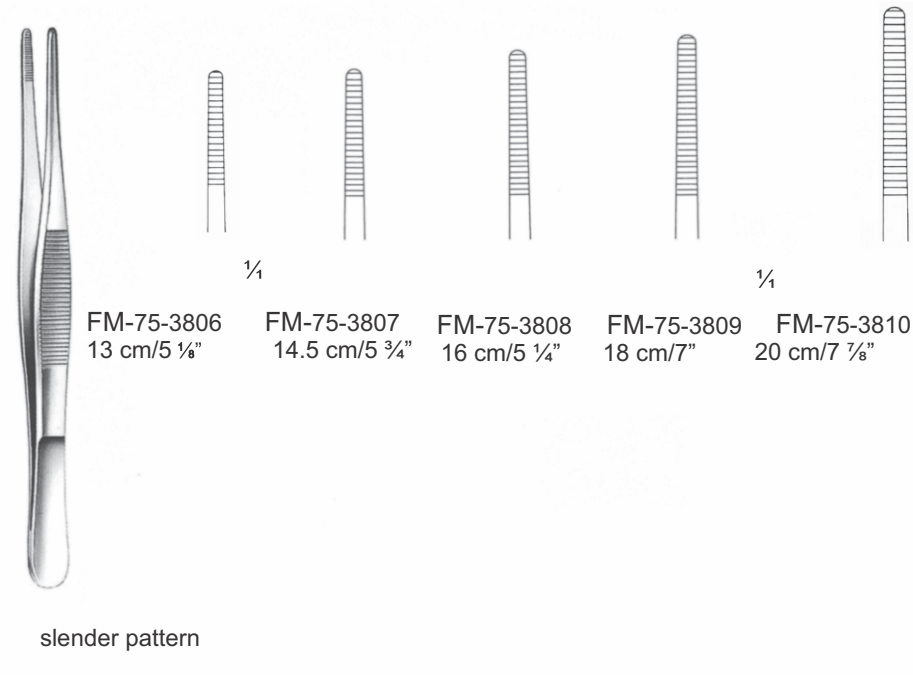
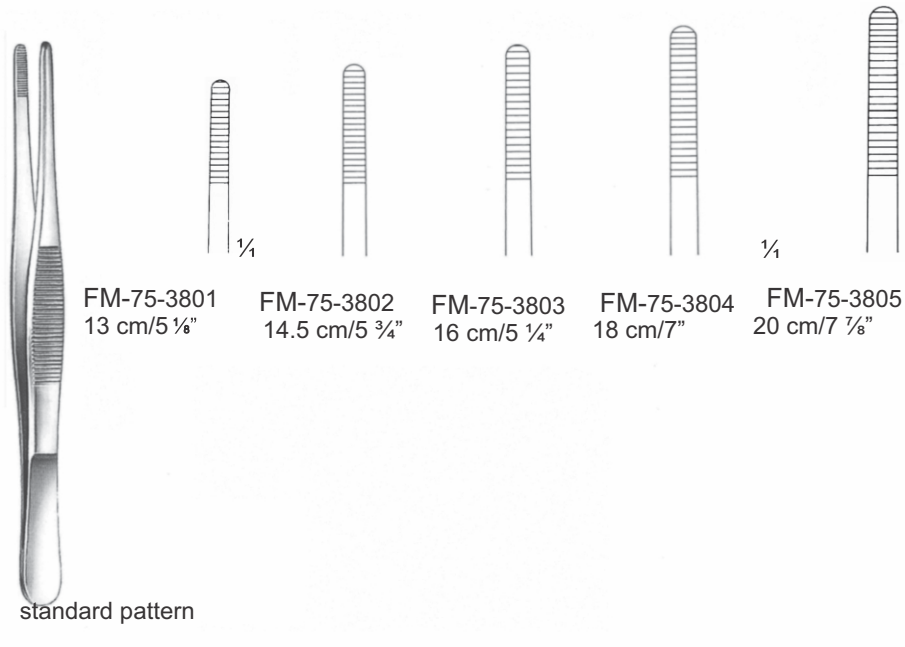

Dressing Forceps	EN
Verbandzange	DE
Vendaje de fórceps	ES
Pince à pansement	FR
Pinze per medicazione	IT

75



FAIZAN & MUSA
SURGICAL

DRESSING FORCEPS

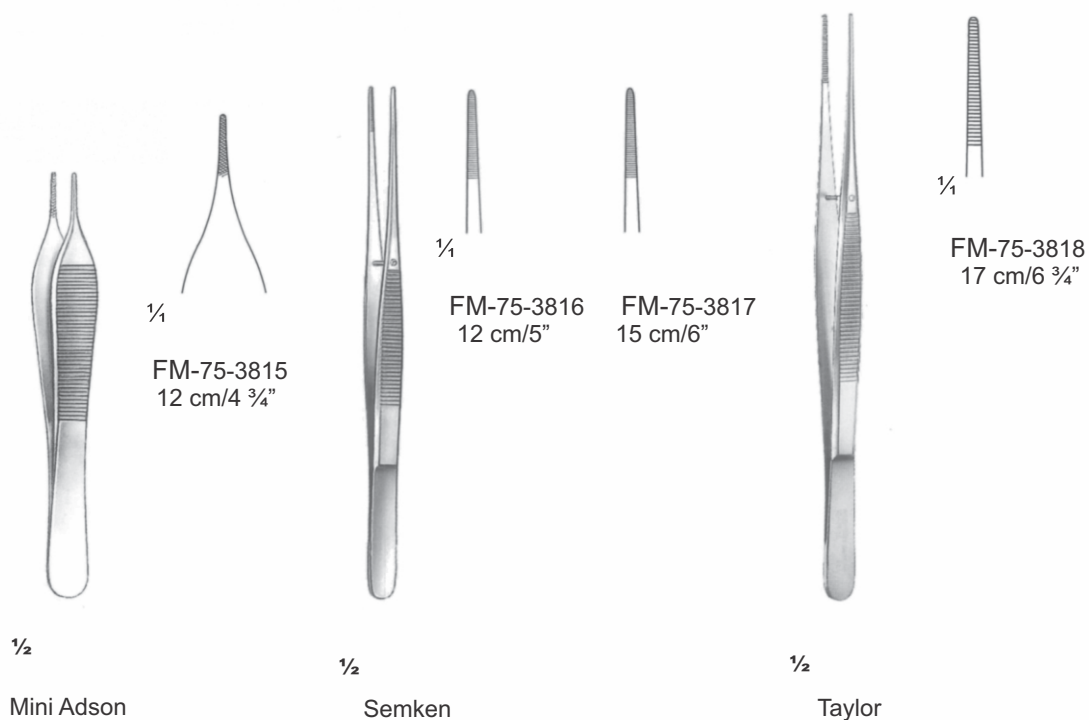
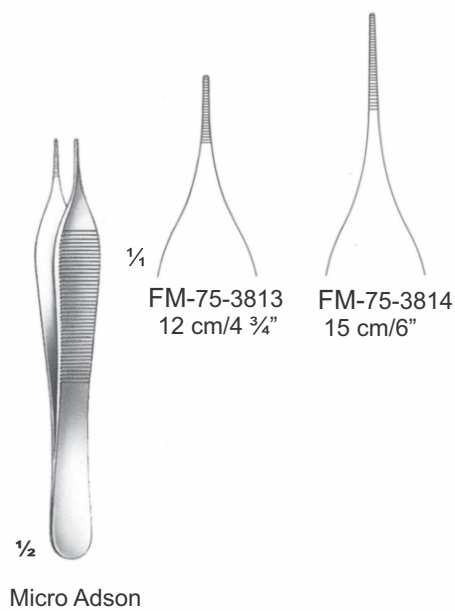
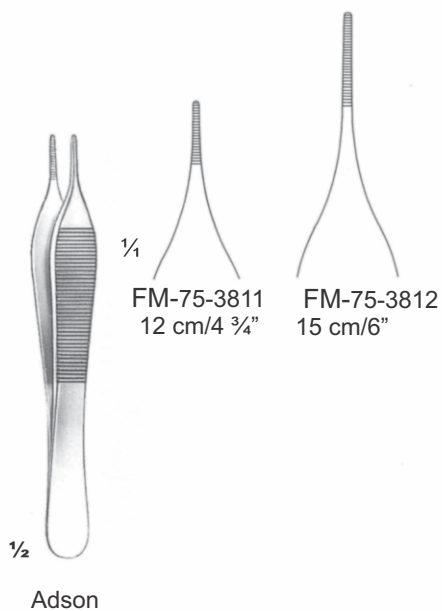

Dressing Forceps	EN
Verbandzange	DE
Vendaje de fórceps	ES
Pince à pansement	FR
Pinze per medicazione	IT

75



DRESSING FORCEPS

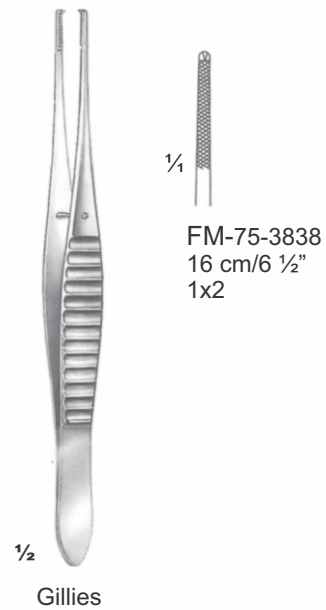
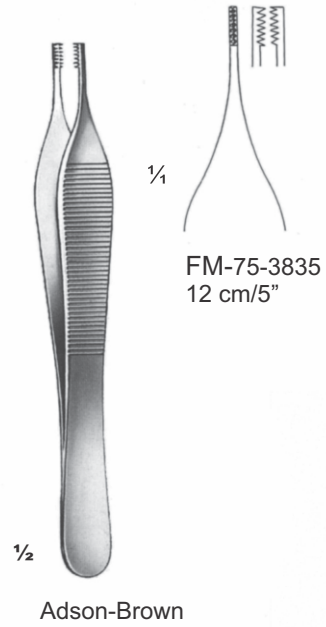
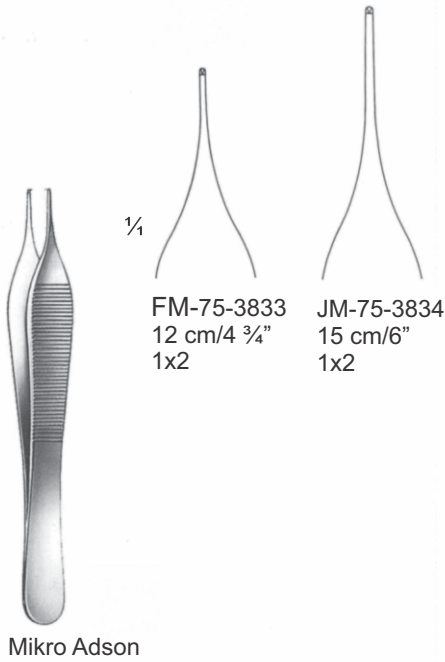

EN	Dressing Forceps
DE	Verbandzange
ES	Vendaje de fórceps
FR	Pince à pansement
IT	Pinze per medicazione



DRESSING FORCEPS



1/4
C-079-15
15 cm/6"

suited to hold silver pins, nerve-broaches and for introducing medicines



1/2
Frigz

D = 1,6 mm D = 2,2 mm



1/4
FM-75-3839
16 cm/6 1/4"



1/4
FM-75-3840
16 cm/6 1/4"



1/2
Frigz



1/4
FM-75-3841
16 cm/6 1/4"



1/2
London-College
15 cm/6"



1/4
FM-75-3842 No. 1 FM-75-3843 No. 3 FM-75-3844 No. 5



1/2
London-College
with lock
15 cm/6"



1/4
FM-75-3845 No. 1 FM-75-3846 No. 3 FM-75-3847 No. 5

Dressing Forceps	EN
Verbandzange	DE
Vendaje de fórceps	ES
Pince à pansement	FR
Pinze per medicazione	IT

75



DRESSING FORCEPS

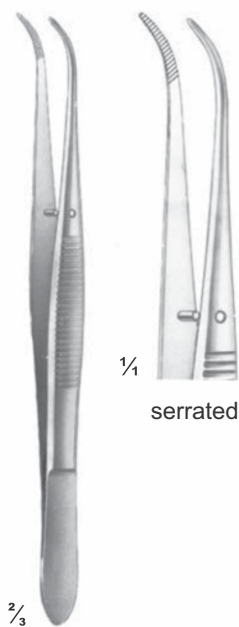

$\frac{2}{3}$
Perry
FM-75-3848
13 cm/5"



$\frac{2}{3}$
Perry
FM-75-3849
13 cm/5"

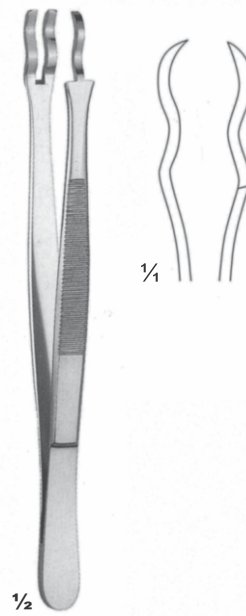

$\frac{1}{2}$
FM-75-3850
14.5 cm/5 $\frac{3}{4}$ "
Frigz
Grasping and
sterilizing forceps

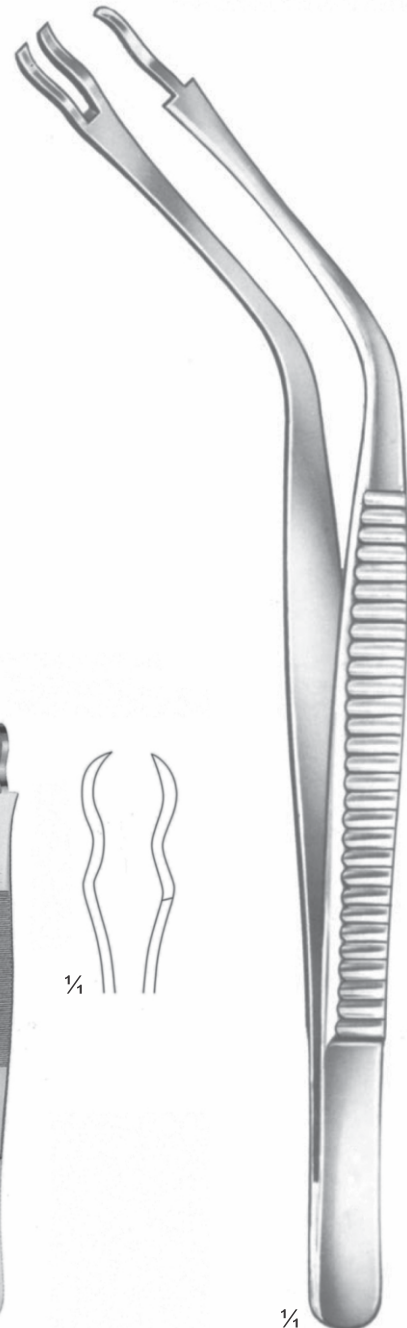

$\frac{1}{4}$
FM-75-3851
20 cm/8"
Seizing and
Sterilizing Forceps

EN	Dressing Forceps
DE	Verbandzange
ES	Vendaje de fórceps
FR	Pince à pansement
IT	Pinze per medicazione

DRESSING FORCEPS

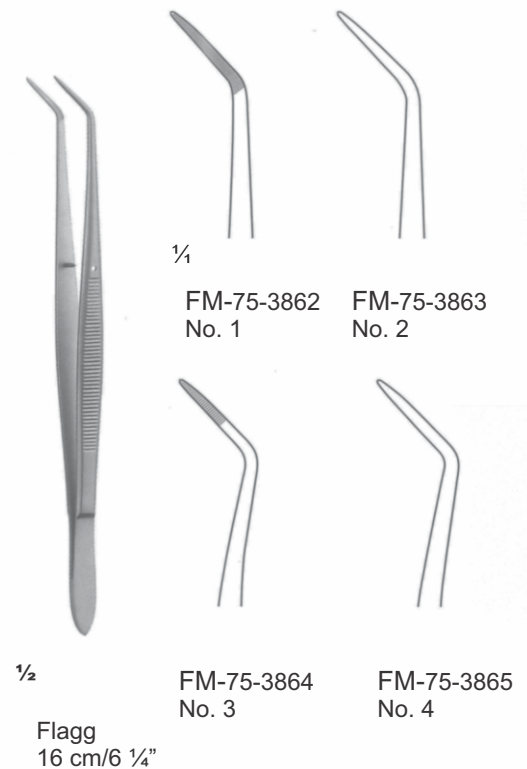
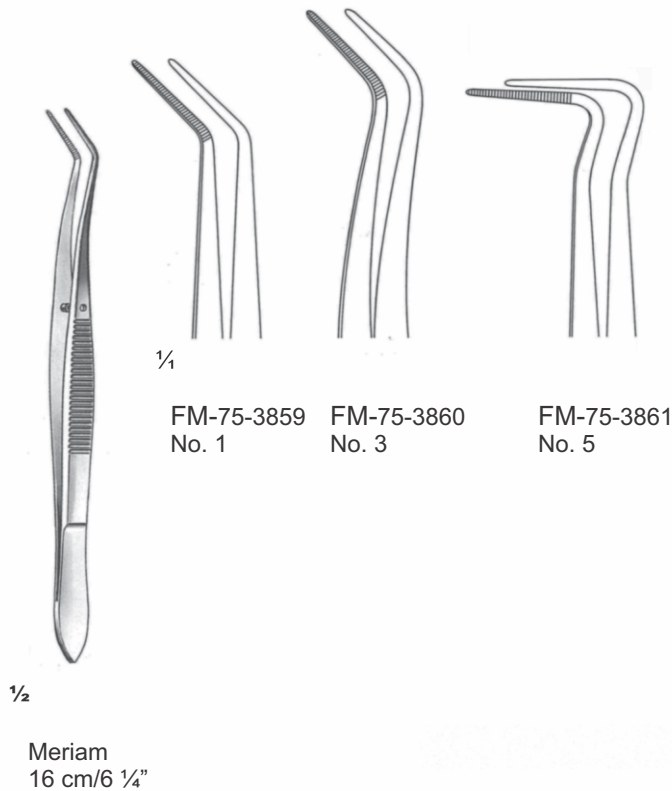
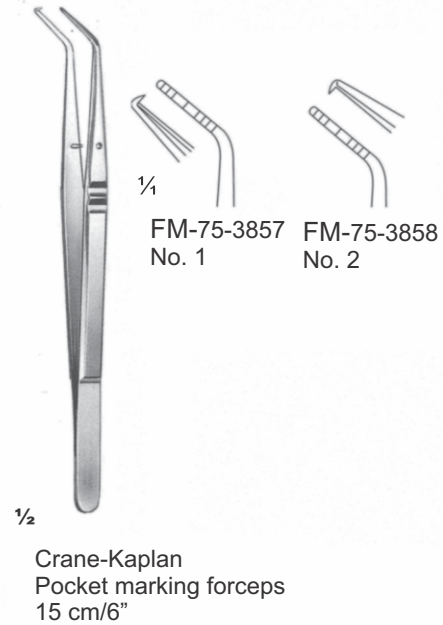
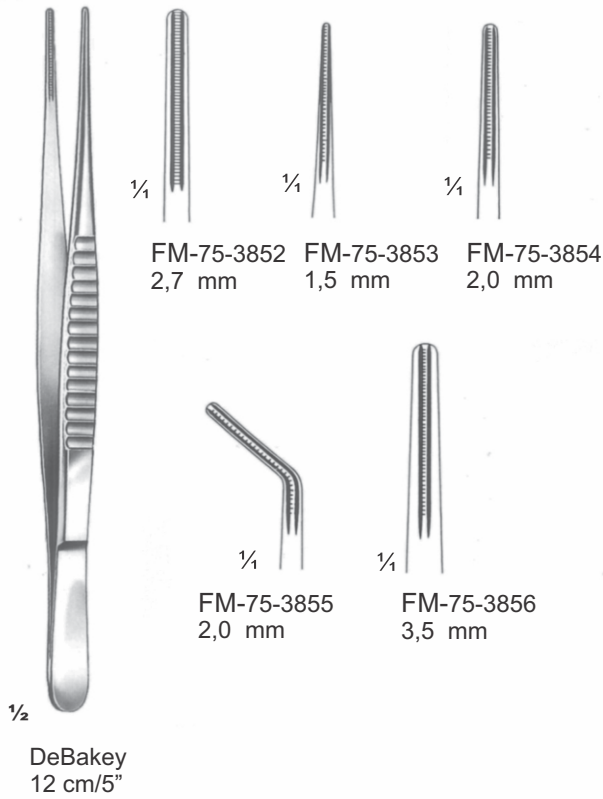

Dressing Forceps	EN
Verbandzange	DE
Vendaje de fórceps	ES
Pince à pansement	FR
Pinze per medicazione	IT

75



DRESSING FORCEPS



EN	Scalpel Handles
DE	Skalpellgriffe
ES	Manches de bistouris
FR	Mangos de Bisturías
IT	Manici per bisturi

Page 202 to 203

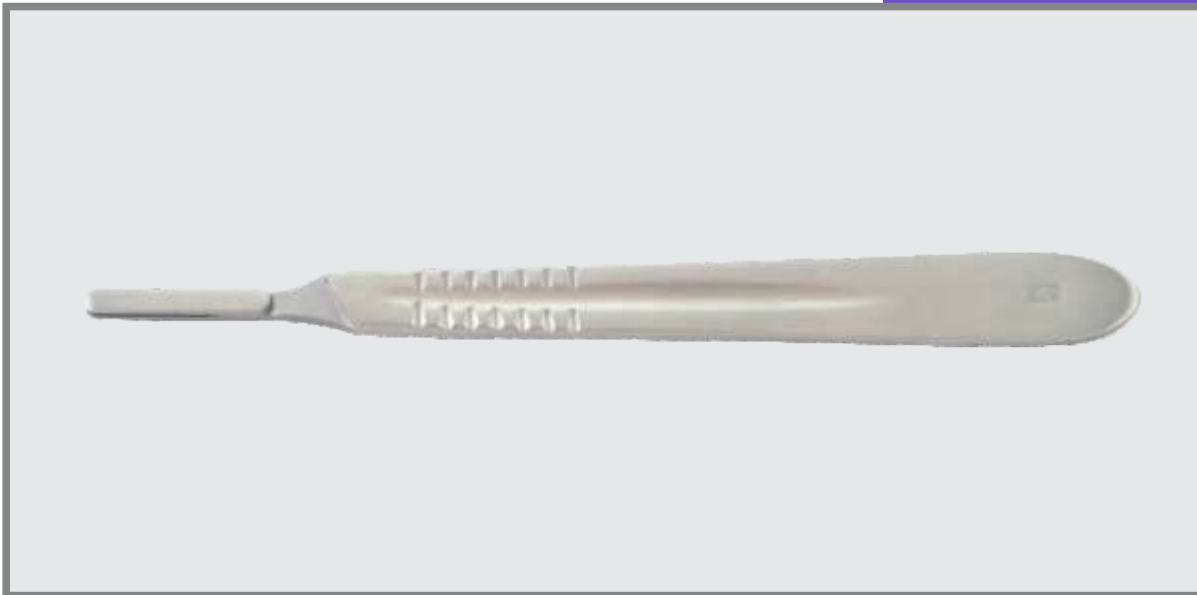

EN	Scalpel Handles
DE	Skalpelli-Griffe
ES	Mangos de bisturios
FR	Poignées de scalpel
IT	Manici per bisturi



Standard
FM-76-3901
3



FM-76-3902
3



FM-76-3903
3
with scale



FM-76-3904-3L # 3L
FM-76-3905-3XL # 3XL

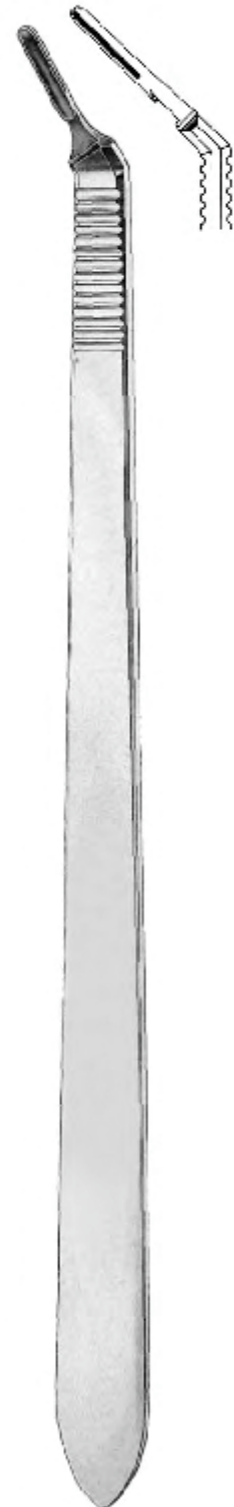

FM-76-3906-3L # 3L
FM-76-3907-3XL # 3XL
angled

Scalpel Handles **EN**
 Skalpell-Griffe **DE**
 Mangos de bisturios **ES**
 Poignées de scalpel **FR**
 Manici per bisturi **IT**

76



OPERATING KNIVES

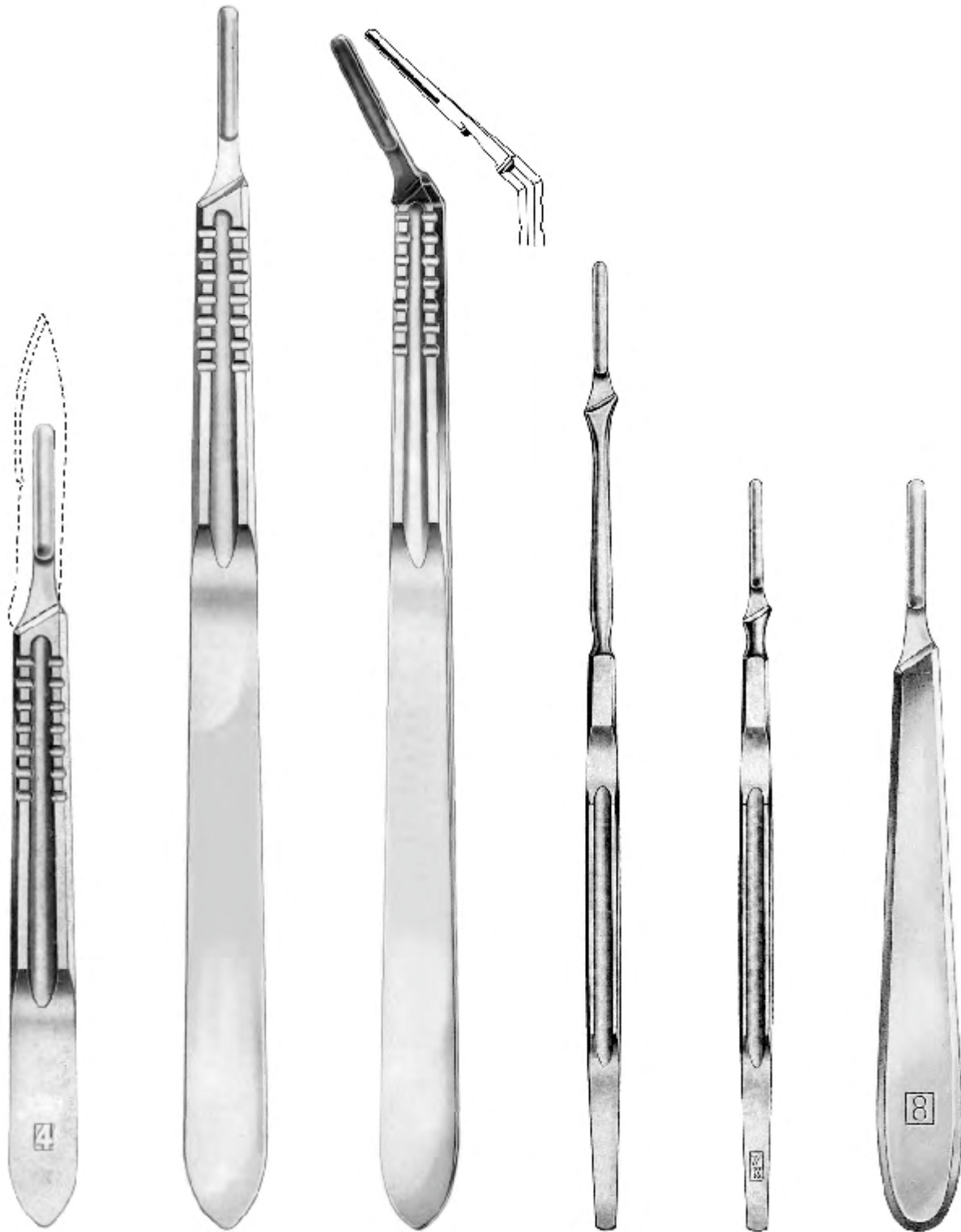

Standard
 FM-76-3908
 # 4

FM-76-3909-4L # 4L
 FM-76-3910-4XL # 4XL

FM-76-3911-4L # 4L
 FM-76-3912-4XL # 4XL
 angled

FM-76-3913
 # 7

FM-76-3914
 # 7K

Collin
 FM-76-3915
 Fig. 8

EN	Mallets
DE	Schlägel
ES	Mazos
FR	Maillets
IT	Mallets

Page 204 to 206

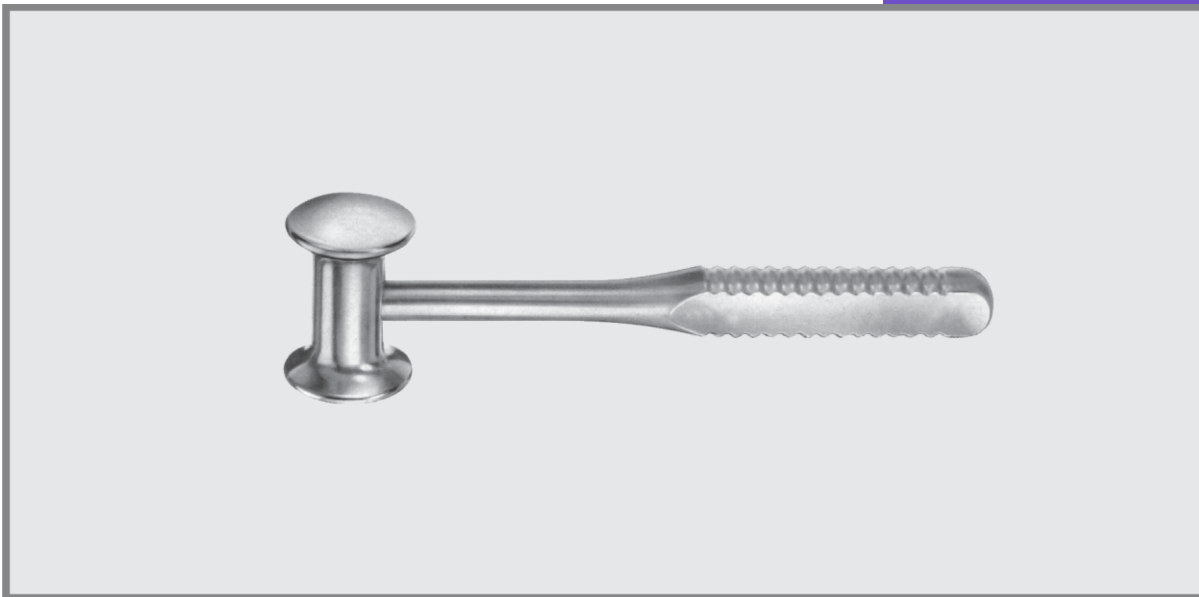

EN	Mallets
DE	Hämmer
ES	Martillos
FR	Maillets
IT	Mallets



MALLETS



BERGMANN
77-3951
24 cm/9 1/2"
300 grams



WILLIGER
24 cm/9 1/2"
lead lled



FM-77-3952
26 mm Ø
275 g



FM-77-3953
28 mmØ
320 g

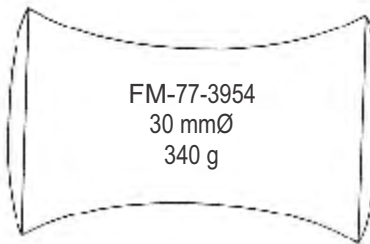

FM-77-3954
30 mmØ
340 g



Ø 27 mm
300 g

PARTSCH
FM-77-3955
18 cm/7 1/8"
with hollow handle

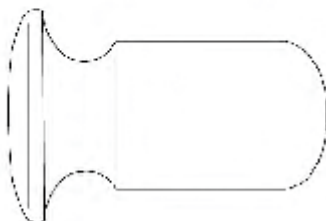
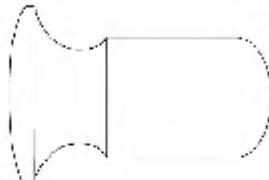
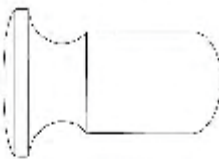

DOYEN
21 cm/8 1/4"

FM-77-3956
25 mmØ
120 g (4 1/4 oz.)
19.5 cm/7 3/4"

FM-77-3957
30 mmØ
180 g (6 1/2 oz.)
19.5 cm/7 3/4"

FM-77-3958
35 mmØ
260 g (9 oz.)
21 cm/8 1/4"



27 mmØ
300 g

with interchangeable plastic disks

MEAD
FM-77-3959 19 cm/7 1/2"
FM-77-3960 pair of spare disks

Mallets	EN
Hämmer	DE
Martillos	ES
Maillets	FR
Mallets	IT

77



MALLETS



HAJEK
FM-77-3961
20 cm/7⁷/₈"
200 g
Ø 27 mm



KIRK
FM-77-3962
21 cm/8¹/₄"
650 g
Ø 38 mm



BERGMANN
FM-77-3963
24.5 cm/9⁵/₈"
400 g
Ø 30 mm



HEATH
FM-77-3964
18.5 cm/7¹/₄"
700 g
Ø 40 mm



with interchangeable
disks
77-3966

FM-77-3965
18.5 cm/7¹/₄"
240 g
Ø 25 mm



OMBREDANNE
FM-77-3967
24 cm/9¹/₂"
700 g
Ø 40 mm

EN	Mallets
DE	Hämmer
ES	Martillos
FR	Maillets
IT	Mallets



FM-77-3968
26.5 cm/10 3/8"
Ø 50 mm
1300 g

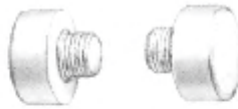

FM-77-3969
spare facings (pair)



FM-77-3970
19 cm/7 1/2"
Ø 25 mm
300 g



HERBERT
FM-77-3971
19 cm/7 1/2"
Ø 25 mm
215 g

EN	Cassettes
DE	Kassetten
ES	Cassettes
FR	Cassettes
IT	cassette

Page 207 to 210



EN	Instruments Cassettes
DE	Instruments Cassettes
ES	Instruments Cassettes
FR	Instruments Cassettes
IT	Cassette per strumenti



Elongated Holes

Dimension(mm)

FM-78-4001	05-Instruments	78 x 182 x 32
FM-78-4002	10-Instruments	142 x 182 x 32
FM-78-4003	20-Instruments	270 x 182 x 32



Round Bottom with Strip Lock

Dimension(mm)

FM-78-4004	05-Instruments	90 x 182 x 25
FM-78-4005	10-Instruments	145 x 182 x 25
FM-78-4006	20-Instruments	270 x 182 x 25



Square

Dimension(mm)

FM-78-4007	05-Instruments	180 x 70 x 22
FM-78-4008	10-Instruments	180 x 130 x 22
FM-78-4009	20-Instruments	260 x 180 x 22



Elongated Holes

		Dimension(mm)
FM-78-4010	05-Instruments	180 x 80 x 35
FM-78-4011	10-Instruments	180 x 145 x 35
FM-78-4012	15-Instruments	210 x 180 x 35
FM-78-4013	20-Instruments	280 x 180 x 35

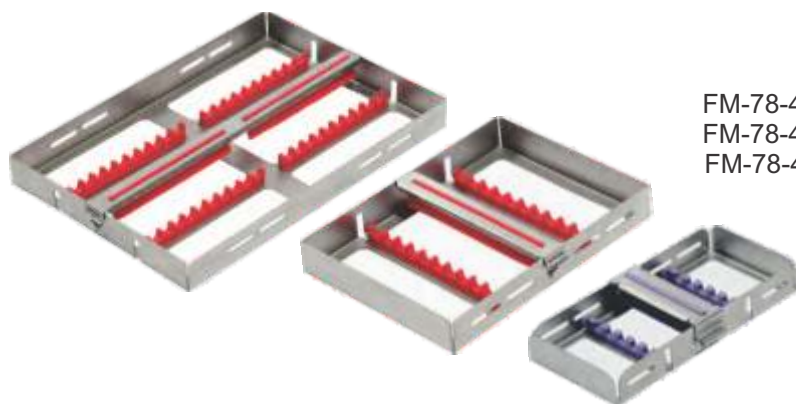

Strip Lock "H" Type

Model		Dimension(mm)
FM-78-4014	05-Instruments	180 x 80 x 25
FM-78-4015	10-Instruments	180 x 130 x 25
FM-78-4016	20-Instruments	260 x 180 x 25



Strip Lock

Model		Dimension(mm)
FM-78-4017	05-Instruments	180 x 80 x 25
FM-78-4018	10-Instruments	180 x 130 x 25
FM-78-4019	20-Instruments	260 x 180 x 25

EN	Instruments Cassettes
DE	Instruments Cassettes
ES	Instruments Cassettes
FR	Instruments Cassettes
IT	Cassette per strumenti



	<u>Dimension(mm)</u>
FM-78-4020	405 x 255 x 50
FM-78-4021	405 x 255 x 70
FM-78-4022	405 x 255 x 100



	<u>Dimension(mm)</u>
FM-78-4023	255 x 245 x 50
FM-78-4024	255 x 245 x 70
FM-78-4025	255 x 245 x 100

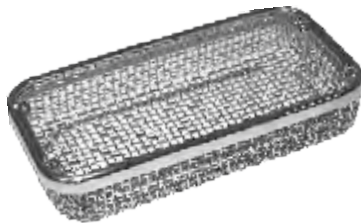

	<u>Dimension(mm)</u>
FM-78-4026	255 x 120 x 50
FM-78-4027	255 x 120 x 70

LIDs (optional)

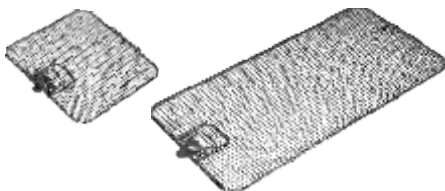

	<u>Dimension(mm)</u>
FM-78-4028	255 x 120
FM-78-4029	255 x 245
FM-78-4030	250 x 240
FM-78-4031	540 x 255
FM-78-4032	485 x 255
FM-78-4033	405 x 255
FM-78-4034	480 x 370
FM-78-4035	480 x 250

Endoscopic Baskets



Dimension(mm)

- FM-78-4036 290 x 80 x 52
- FM-78-4037 460 x 80 x 52



Dimension(mm)

- FM-78-4038 670 x 80 x 52
- FM-78-4039 700 x 80 x 52



Dimension(mm)

- FM-78-4040 290 x 160 x 52
- FM-78-4041 310 x 150 x 77
- FM-78-4042 460 x 160 x 77
- FM-78-4043 640 x 150 x 77
- FM-78-4044 660 x 150 x 77
- FM-78-4045 460 x 160 x 52
- FM-78-4046 580 x 160 x 52

EN	Cylinder cartridge syringe
DE	Zylinder-Ampullenspritze
ES	Seringue á ampoule cylindrique
FR	Jeringo para cartucho ampollas
IT	Siringe ampollare a cilindro

Page 211 to 216



EN	Cartridge syringes
DE	Ampullenspritzen
ES	Jeringas para cartucho apollas
FR	Lima para huesos
IT	Lima per ossa



FM-79-4101

Cylinder cartridge syringe
1.8 cc, without aspiration
metric thread / US Thread

FM-79-4103

Cylinder cartridge syringe
2.2 cc, without aspiration
metric thread / US Thread

FM-79-4102

Cylinder cartridge syringe
1.8 cc, with aspiration
metric thread / US Thread

FM-79-4104

Cylinder cartridge syringe
2.2 cc, with aspiration
metric thread / US Thread



FM-79-4105

Cylinder cartridge syringe
1.8 cc, without aspiration with
metric thread / US Thread

FM-79-4107

Cylinder cartridge syringe
2.2 cc, without aspiration with
metric thread / US Thread

FM-79-4106

Cylinder cartridge syringe
1.8 cc, with aspiration with
metric thread / US Thread

FM-79-4108

Cylinder cartridge syringe
2.2 cc, with aspiration with
metric thread / US Thread

Cartridge syringes **EN**

Ampullenspritzen **DE**

Jeringas para cartucho apollas **ES**

Lima para huesos **FR**

Lima per ossa **IT**

79



FM-79-4109

Cylinder cartridge syringe
1.8 cc, without aspiration
metric thread / US Thread

FM-79-4111

Cylinder cartridge syringe
2.2 cc, without aspiration
metric thread / US Thread

FM-79-4110

Cylinder cartridge syringe
1.8 cc, with aspiration
metric thread / US Thread

FM-79-4112

Cylinder cartridge syringe
2.2 cc, with aspiration
metric thread / US Thread



FM-79-4113

Cylinder Cartridge Syringe
1.8cc without Aspiration
metric thread / US Thread

FM-79-4115

Cylinder Cartridge Syringe
2.2cc without Aspiration
metric thread / US Thread

FM-79-4114

Cylinder Cartridge Syringe
1.8cc with Aspiration
metric thread / US Thread

FM-79-4116

Cylinder Cartridge Syringe
2.2cc with Aspiration
metric thread / US Thread

EN Cartridge syringes

DE Ampullenspritzen

ES Jeringas para cartucho apollas

FR Lima para huesos

IT Lima per ossa



FM-79-4117
Cylinder Cartridge Syringe
1.8cc without Aspiration
metric thread / US Thread
Plastic base & handle sand blast
nish steel rod.

FM-79-4118
Cylinder Cartridge Syringe
1.8cc with Aspiration
metric thread / US Thread
Plastic base & handle sand blast
nish steel rod.

FM-79-4119
Cylinder Cartridge Syringe
2.2cc without Aspiration
metric thread / US Thread
Plastic base & handle sand blast
nish steel rod.

FM-79-4120
Cylinder Cartridge Syringe
2.2cc with Aspiration
metric thread / US Thread
Plastic base & handle sand blast
nish steel rod.



FM-79-4121
Cylinder Cartridge Syringe
1.8cc without Aspiration
metric thread / US Thread

FM-79-4122
Cylinder Cartridge Syringe
1.8cc with Aspiration
metric thread / US Thread

FM-79-4123
Cylinder Cartridge Syringe
2.2cc without Aspiration
metric thread / US Thread

FM-79-4124
Cylinder Cartridge Syringe
2.2cc with Aspiration
metric thread / US Thread

Cartridge syringes **EN**

Ampullenspritzen **DE**

Jeringas para cartucho apollas **ES**

Lima para huesos **FR**

Lima per ossa **IT**

79



SYRINGES



FM-79-4125
Cylinder Cartridge Syringe
1.8cc without Aspiration
metric thread / US Thread

FM-79-4127
Cylinder Cartridge Syringe
2.2cc without Aspiration
metric thread / US Thread

FM-79-4126
Cylinder Cartridge Syringe
1.8cc with Aspiration
metric thread / US Thread

FM-79-4128
Cylinder Cartridge Syringe
2.2cc with Aspiration
metric thread / US Thread



FM-79-4129
Cylinder Cartridge Syringe
1.8cc without Aspiration
metric thread / US Thread

FM-79-4131
Cylinder Cartridge Syringe
2.2cc without Aspiration
metric thread / US Thread

FM-79-4130
Cylinder Cartridge Syringe
1.8cc with Aspiration
metric thread / US Thread

FM-79-4132
Cylinder Cartridge Syringe
2.2cc with Aspiration
metric thread / US Thread

EN Cartridge syringes

DE Ampullenspritzen

ES Jeringas para cartucho apollas

FR Lima para huesos

IT Lima per ossa



FM-79-4133
Cylinder Cartridge Syringe
1.8cc without Aspiration
metric thread / US Thread

FM-79-4135
Cylinder Cartridge Syringe
2.2cc without Aspiration
metric thread / US Thread

FM-79-4134
Cylinder Cartridge Syringe
1.8cc with Aspiration
metric thread / US Thread

FM-79-4136
Cylinder Cartridge Syringe
2.2cc with Aspiration
metric thread / US Thread



FM-79-4137
Aspirating Syringe
1.8cc with x tip, S/S
metric thread / US Thread

FM-79-4138
Aspirating Syringe
2.2cc with x tip, S/S
metric thread / US Thread

Cartridge syringes	EN
Ampullenspritzen	DE
Jeringas para cartucho apollas	ES
Lima para huesos	FR
Lima per ossa	IT

79



SYRINGES

Intra-Ligamentale Syringes

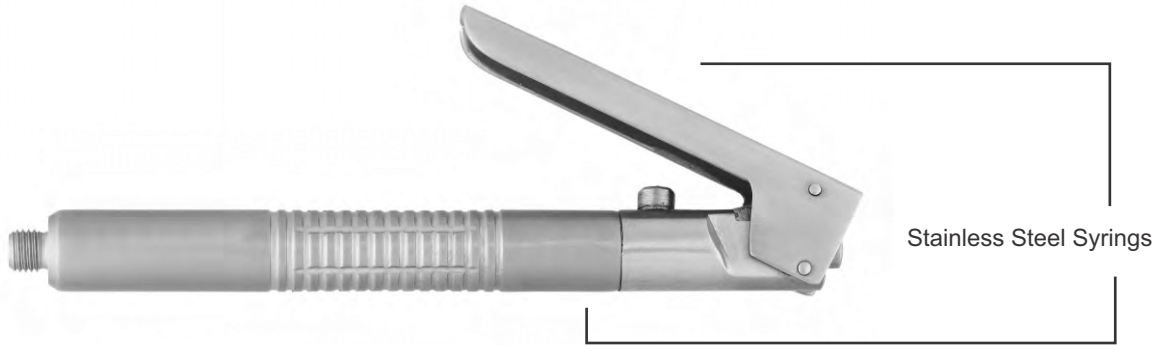

Stainless Steel Syringes

FM-79-4139
 1.8 cc metric thread / US Thread
 2.2 cc metric thread / US Thread

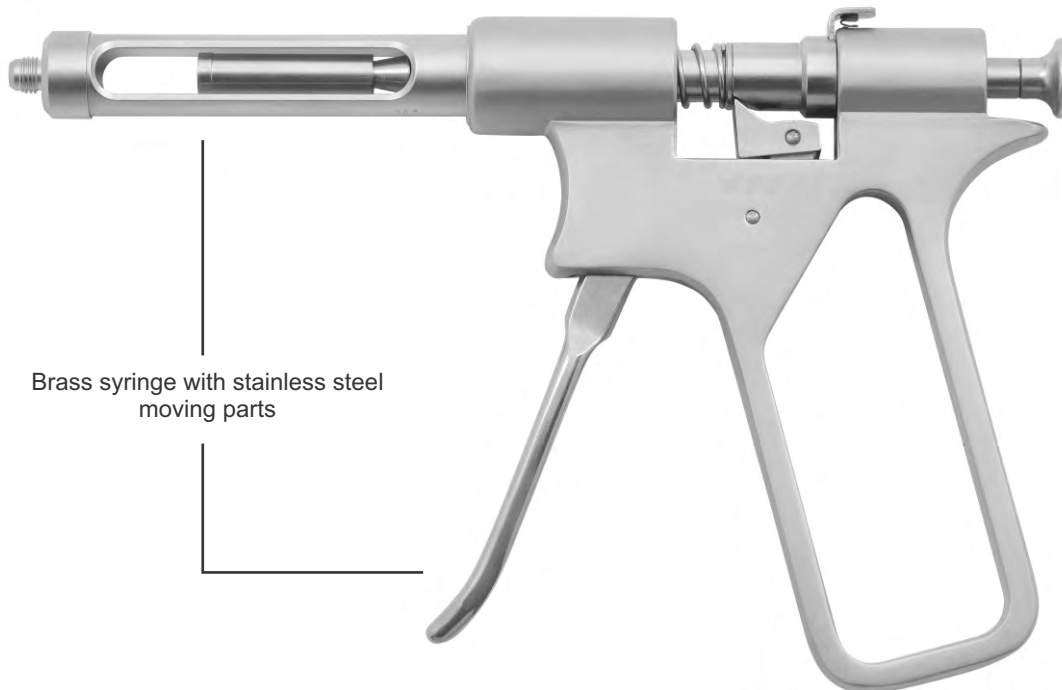

Brass syringe with stainless steel moving parts

FM-79-4140
 1.8 cc metric thread / US Thread
 2.2 cc metric thread / US Thread

- EN** Impression Trays
- DE** Abdrucklöffel
- ES** Porte empreintes
- FR** Cubetas para impresiones
- IT** Portaimpronte

Page 217 to 228

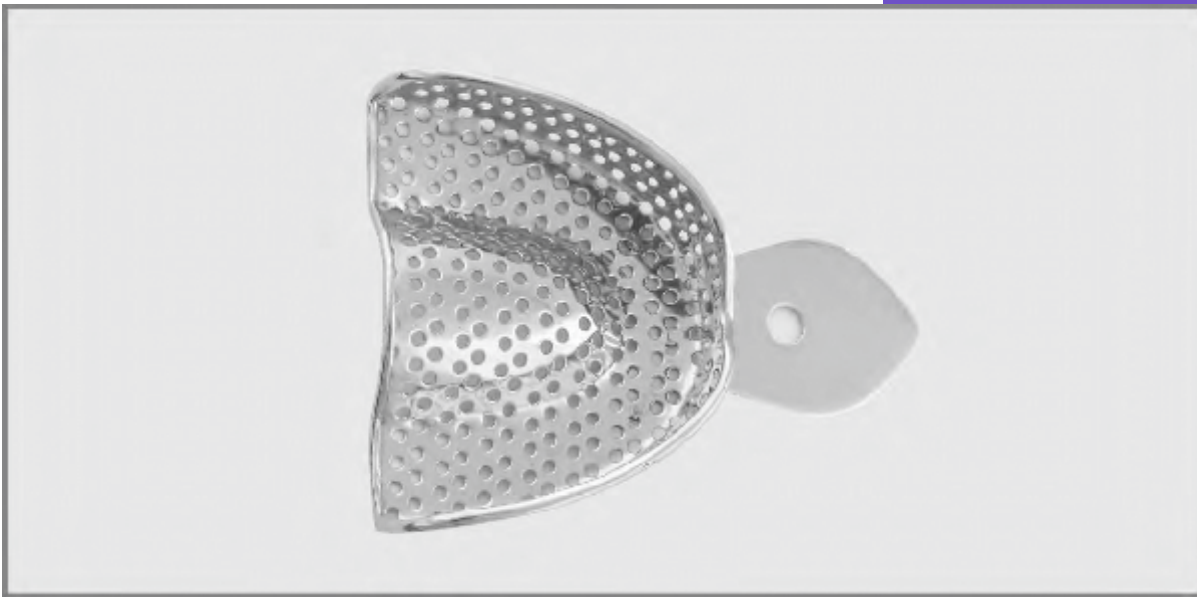

EN Impression Trays Perforated with Rim Lock
DE Abdrucklöffel perforiert mit Rim Lock
ES Bandejas de impresión perforadas con borde de bloqueo
FR Plateaux d'empreinte perforés avec verrouillage de la jante
IT Vassoio per impronta perforati con Cerchione



IMPRESSION TRAYS

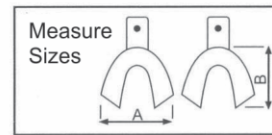
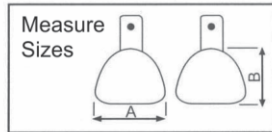
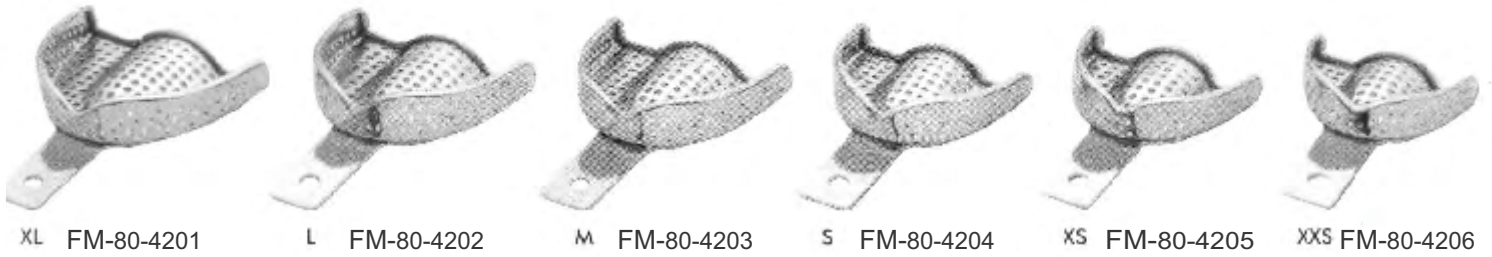

Upper		A (left-right)	B (top-bottom)
80-4201	XL	81 mm	63 mm
80-4202	L	73 mm	58 mm
80-4203	M	71 mm	52 mm
80-4204	S	67 mm	53 mm
80-4205	XS	65 mm	51 mm
80-4206	XXS	61 mm	50 mm

Lower		A (left-right)	B (top-bottom)
80-4207	XL	78 mm	63 mm
80-4208	L	74 mm	62 mm
80-4209	M	72 mm	59 mm
80-4210	S	70 mm	57 mm
80-4211	XS	69 mm	55 mm
80-4212	XXS	59 mm	50 mm

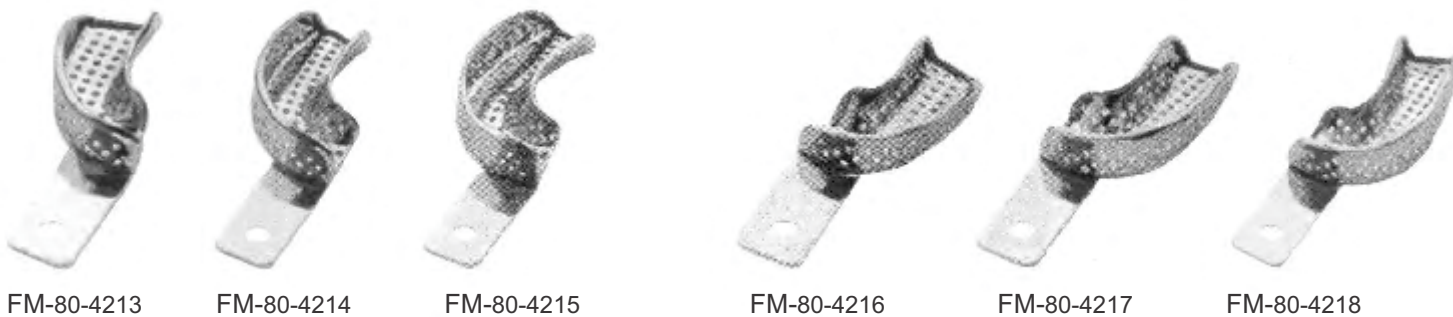
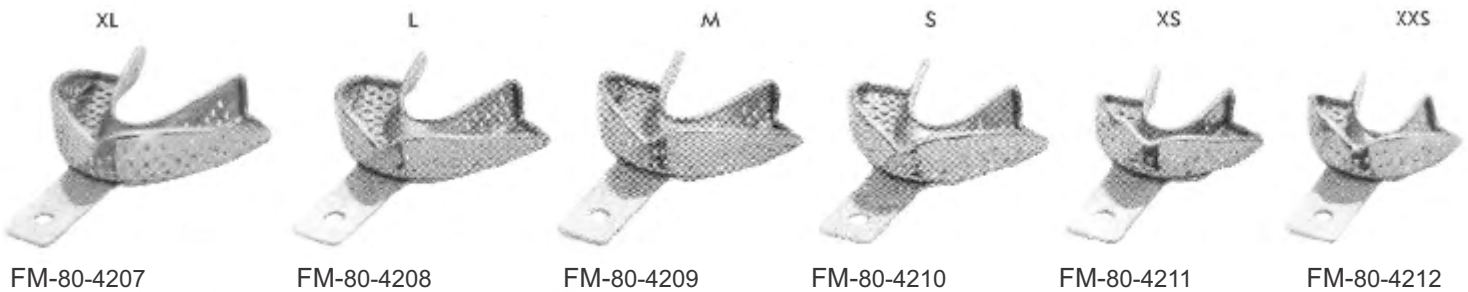

Impression Trays Solid with Rim Lock **EN**

Abformlöffel Solid mit Rim Lock **DE**

Bandejas de impresión sólidas con borde de bloqueo **ES**

Bacs à empreintes Solid avec Rim Lock **FR**

Vassoi per impronte solidi con blocco del bordo **IT**

80



IMPRESSION TRAYS

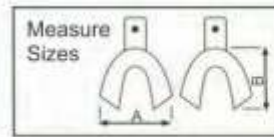
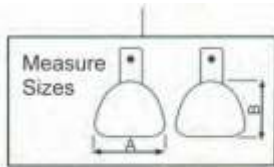
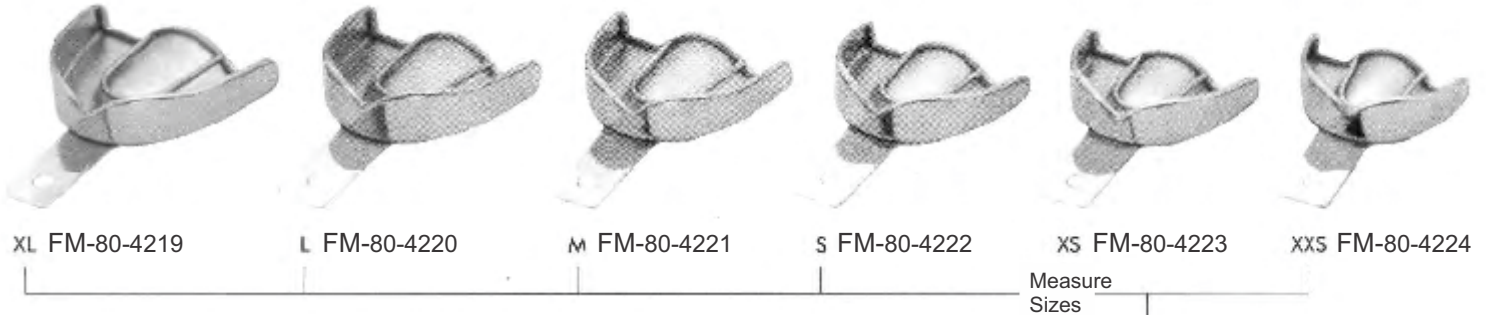

Upper		A (left-right)	B (top-bottom)
81-4219	XL	81 mm	63 mm
81-4220	L	73 mm	58 mm
81-4221	M	71 mm	52 mm
81-4222	S	67 mm	53 mm
81-4223	XS	65 mm	51 mm
81-4224	XXS	61 mm	50 mm

Lower		A (left-right)	B (top-bottom)
81-4225	XL	78 mm	63 mm
81-4226	L	74 mm	62 mm
81-4227	M	72 mm	59 mm
81-4228	S	70 mm	57 mm
81-4229	XS	69 mm	55 mm
81-4201	XXS	59 mm	50 mm

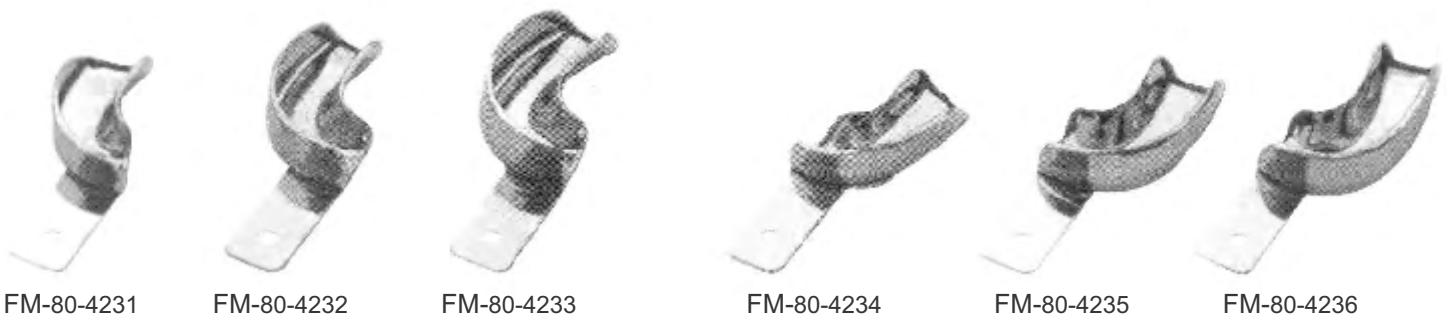
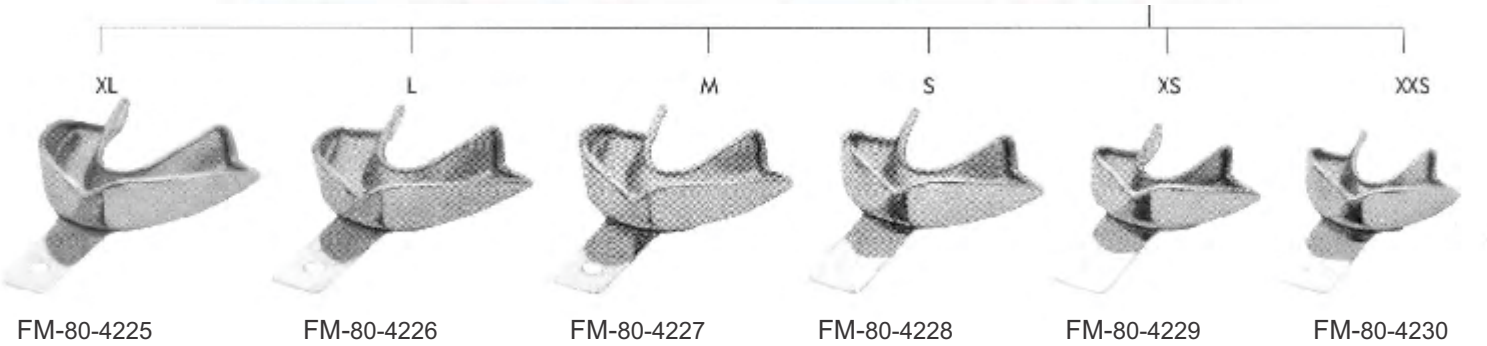

- EN** Impression Trays Solid with Rim Lock
- DE** Abformlöffel Solid mit Rim Lock
- ES** Bandejas de impresión sólidas con borde de bloqueo
- FR** Bacs à empreintes Solid avec Rim Lock
- IT** Vassoi per impronte solidi con blocco del bordo



IMPRESSION TRAYS

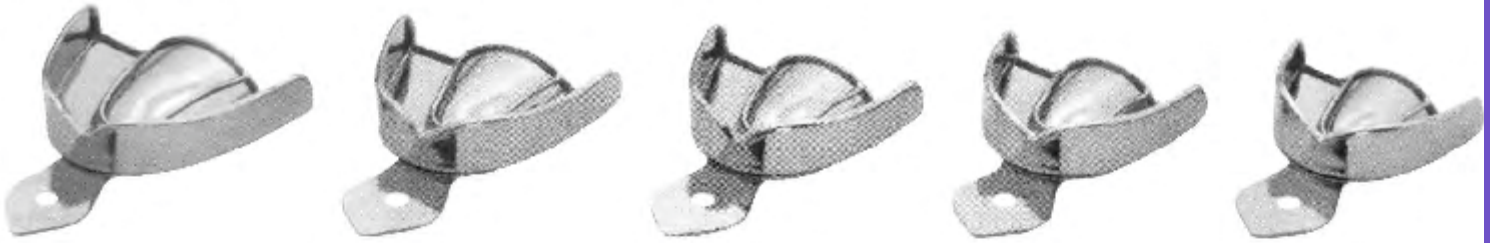

FM-80-4237

FM-80-4238

FM-80-4239

FM-80-4240

FM-80-4241

XL

L

M

S

XS

Upper		A (left-right)	B (top-bottom)
80-4237	XL	81 mm	63 mm
80-4238	L	73 mm	58 mm
80-4239	M	71 mm	52 mm
80-4240	S	67 mm	53 mm
80-4241	XS	65 mm	51 mm

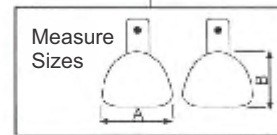

Lower		A (left-right)	B (top-bottom)
80-4242	XL	78 mm	63 mm
80-4243	L	74 mm	62 mm
80-4244	M	72 mm	59 mm
80-4245	S	70 mm	57 mm
80-4246	XS	69 mm	55 mm

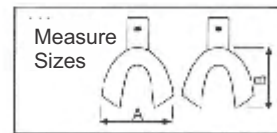

XL

L

M

S

XS



FM-80-4242

FM-80-4243

FM-80-4244

FM-80-4245

FM-80-4246

Impression Trays Perforated without Rim Lock EN

Abdrucklöffel perforiert ohne Rim Lock DE

Bandejas de impresión perforadas sin borde de bloqueo ES

Plateaux d'empreinte perforés sans verrouillage de la jante FR

Vassoi per impronta perforati senza cerchia IT

80



IMPRESSION TRAYS

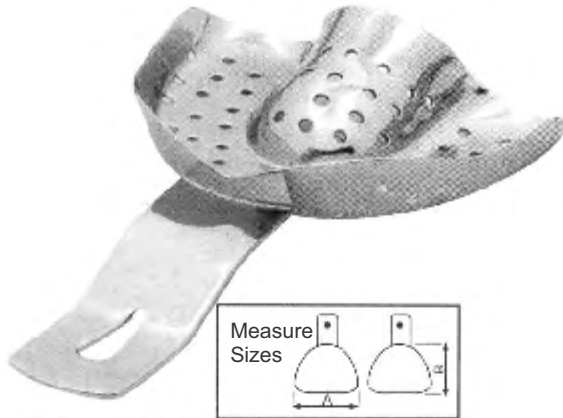

For Toothed Upper Jaws
(Fig. 0 for children)

	A	B
	mm.	mm.
80-4247 0	59	52
80-4248 1	66	52
80-4249 2	71	62
80-4250 3	71	64
80-4251 4	80	70

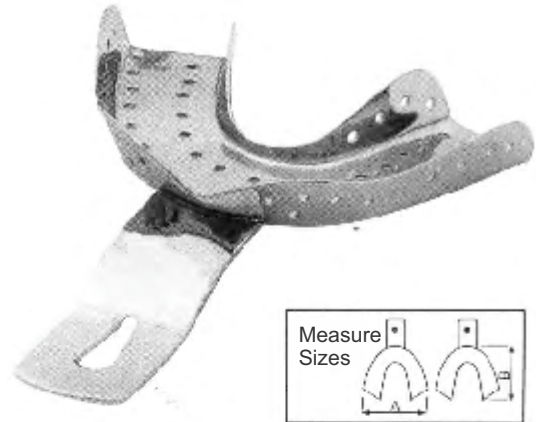

For Toothed Lower Jaws
(Fig. 0 for children)

	A	B
	mm.	mm.
80-4252 0	65	46
80-4253 1	67	50
80-4254 2	76	54
80-4255 3	79	56
80-4256 4	79	61



For Narrow Toothed Upper Jaws

	A	B
	mm.	mm.
80-4257 2	70	54

- EN** Impression Trays Perforated without Rim Lock
- DE** Abdrucklöffel perforiert ohne Rim Lock
- ES** Bandejas de impresión perforadas sin borde de bloqueo
- FR** Plateaux d'empreinte perforés sans verrouillage de la jante
- IT** Vassoio per impronta perforati senza cerchia



IMPRESSION TRAYS



For partially toothed upper jaws

	A mm.	B mm.
FM-80-4258	62	50
FM-80-4259	70	56

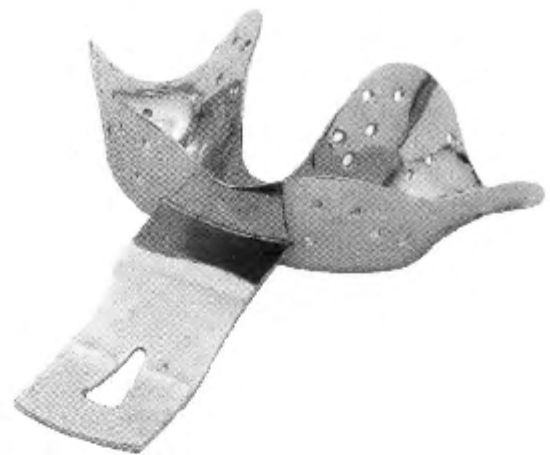
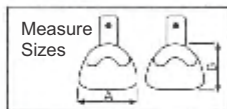

For partially toothed lower jaws

	A mm.	B mm.
FM-80-4260	70	55
FM-80-4261	78	59

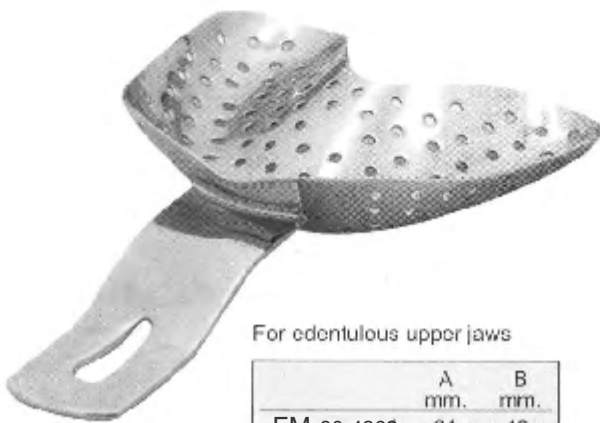
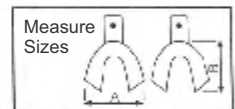

For edentulous upper jaws

	A mm.	B mm.
FM-80-4262	64	46
FM-80-4263	68	53
FM-80-4264	79	61

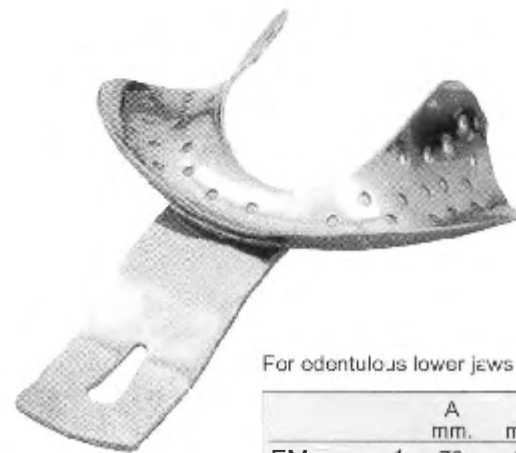

For edentulous lower jaws

	A mm.	B mm.
FM-80-4265 ¹	70	48
FM-80-4266 ²	70	53
FM-80-4267 ³	72	57

Impression Trays Perforated with Rim Lock **EN**

Abdrucklöffel perforiert mit Rim Lock **DE**

Bandejas de impresión perforadas con borde de bloqueo **ES**

Plateaux d'empreinte perforés avec verrouillage de la jante **FR**

Vassoi per impronta perforati con Cerchione **IT**

80



IMPRESSION TRAYS



Solid stainless steel anterior depressed impression trays with retention rim.

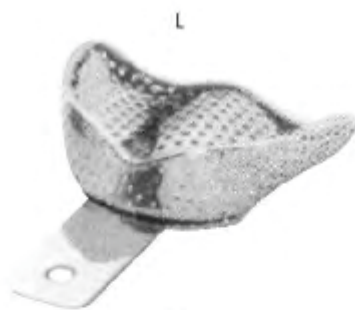
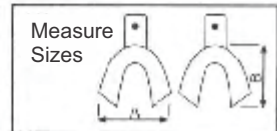
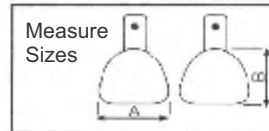

FM-80-4268

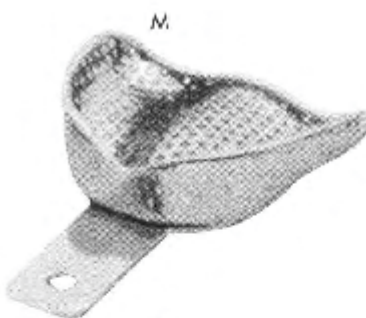

FM-80-4269

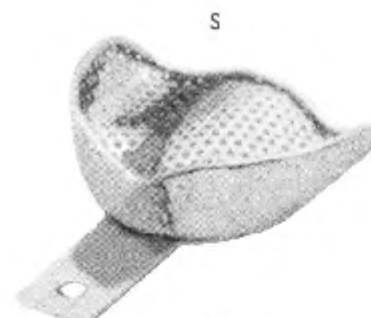

FM-80-4270



FM-80-4271

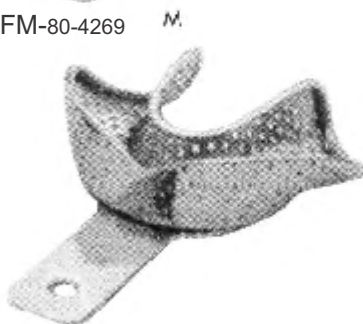

FM-80-4272



FM-80-4273

		A	B
		mm.	mm.
FM-80-4268	L	81	67
FM-80-4269	M	71	64
FM-80-4270	S	70	57

		A	B
		mm.	mm.
FM-80-4271	L	81	60
FM-80-4272	M	79	57
FM-80-4273	S	76	54

EN Impression Trays Perforated Full Denture
 DE Abdrucklöffel perforierte Vollprothese
 ES Bandeja de impresión con dentadura completa perforada
 FR Impression Trays Perforé Prothèse complète
 IT Vassoi per impronte Dentatura piena perforata



IMPRESSION TRAYS



Solid total denture stainless steel impression trays with rim.

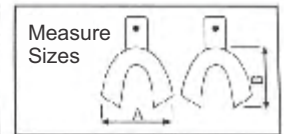
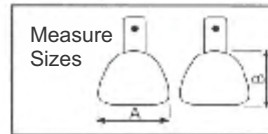

FM-80-4274



FM-80-4275

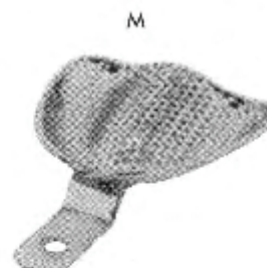

FM-80-4276

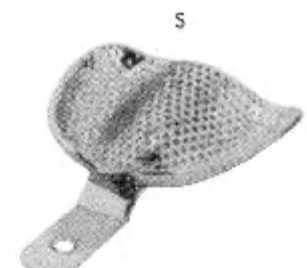

FM-80-4277



FM-80-4278

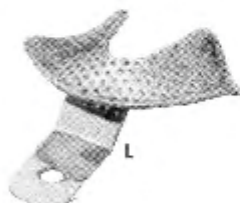

FM-80-4279



FM-80-4280



FM-80-4281

		A mm.	B mm.
FM-80-4274	XL	79	70
FM-80-4275	L	76	67
FM-80-4276	M	70	64
FM-80-4277	S	73	60

		A mm.	B mm.
FM-80-4278	XL	86	64
FM-80-4279	L	70	64
FM-80-4280	M	73	60
FM-80-4281	S	70	57

Impression Trays Solid with Rim Lock **EN**

Abformlöffel Solid mit Rim Lock **DE**

Bandejas de impresión sólidas con borde de bloqueo **ES**

Bacs à empreintes Solid avec Rim Lock **FR**

Vassoi per impronte solidi con blocco del bordo **IT**

80



IMPRESSION TRAYS

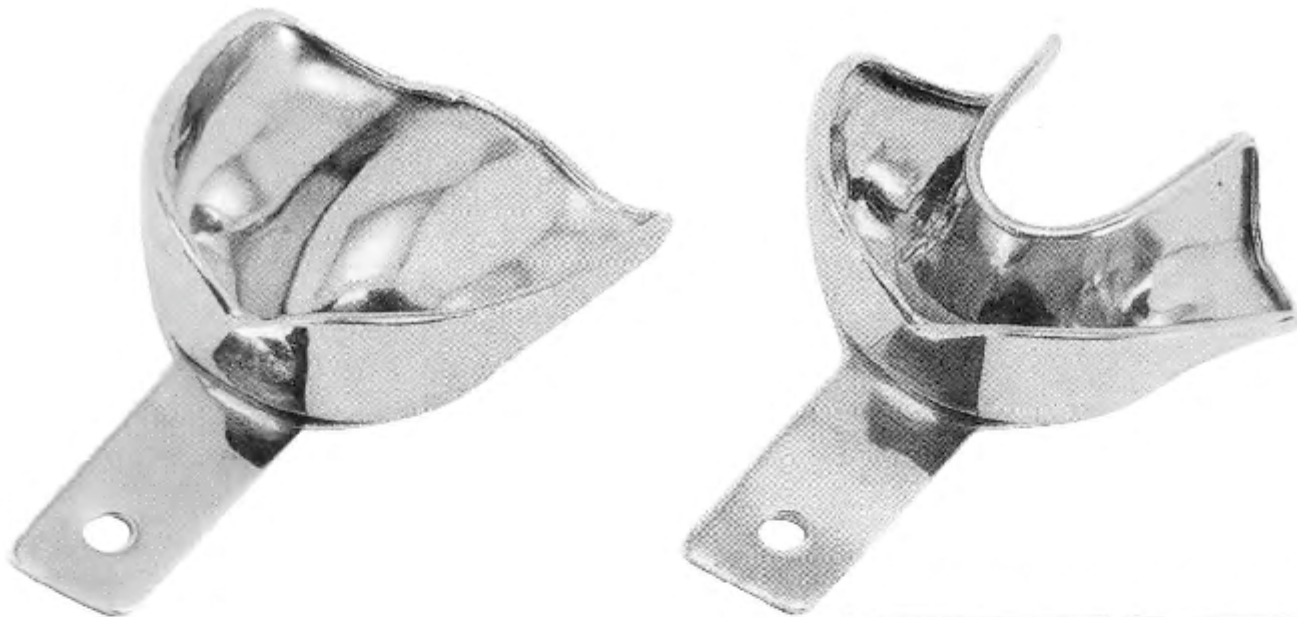

Solid stainless steel anterior depressed impression trays with retentor rim.

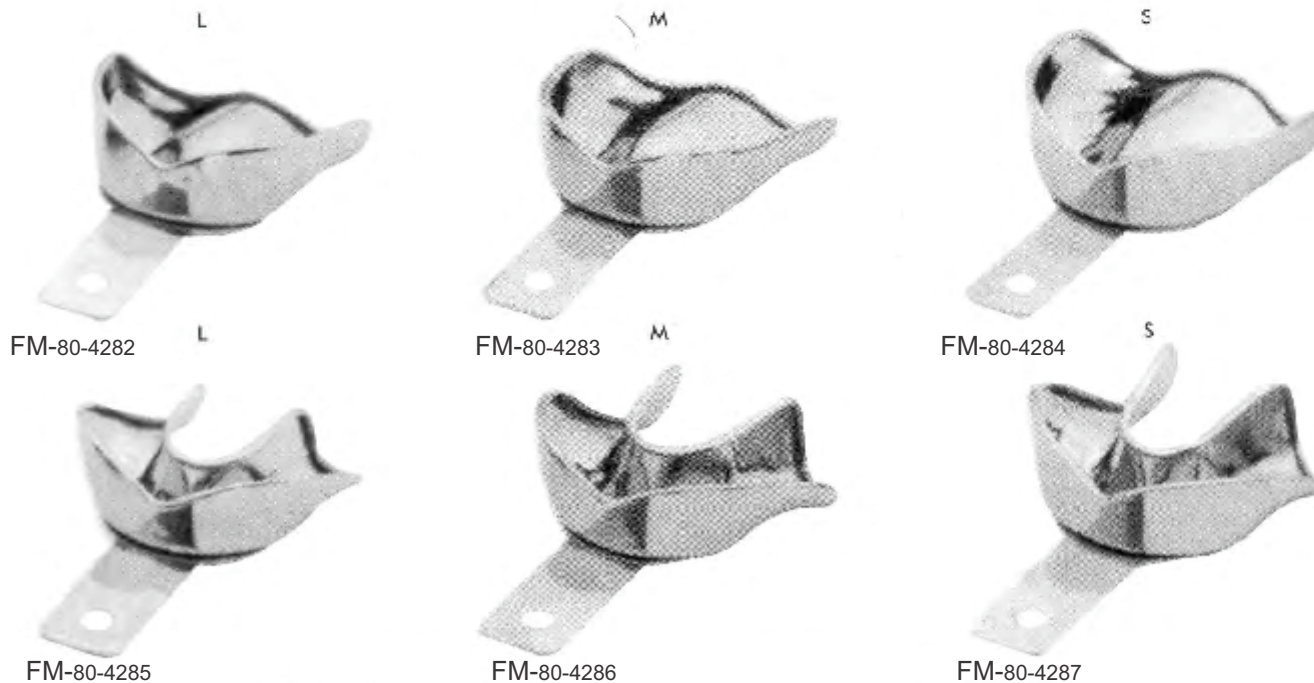
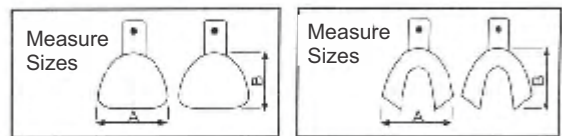

FM-80-4282

FM-80-4283

FM-80-4284

FM-80-4285

FM-80-4286

FM-80-4287

	A	B
	mm.	mm.
FM-80-4282 L	81	67
FM-80-4283 M	71	64
FM-80-4284 S	70	57

	A	B
	mm.	mm.
FM-80-4285 L	81	60
FM-80-4286 M	79	57
FM-80-4287 S	76	54

- EN Impression Trays Solid Full Denture
- DE Abdrucklöffel Solid Full Denture
- ES Bandejas de impresión Solid Full Denture
- FR Impression Trays pleine prothèse complète
- IT Impressione vassoi piena protesi totale



IMPRESSION TRAYS

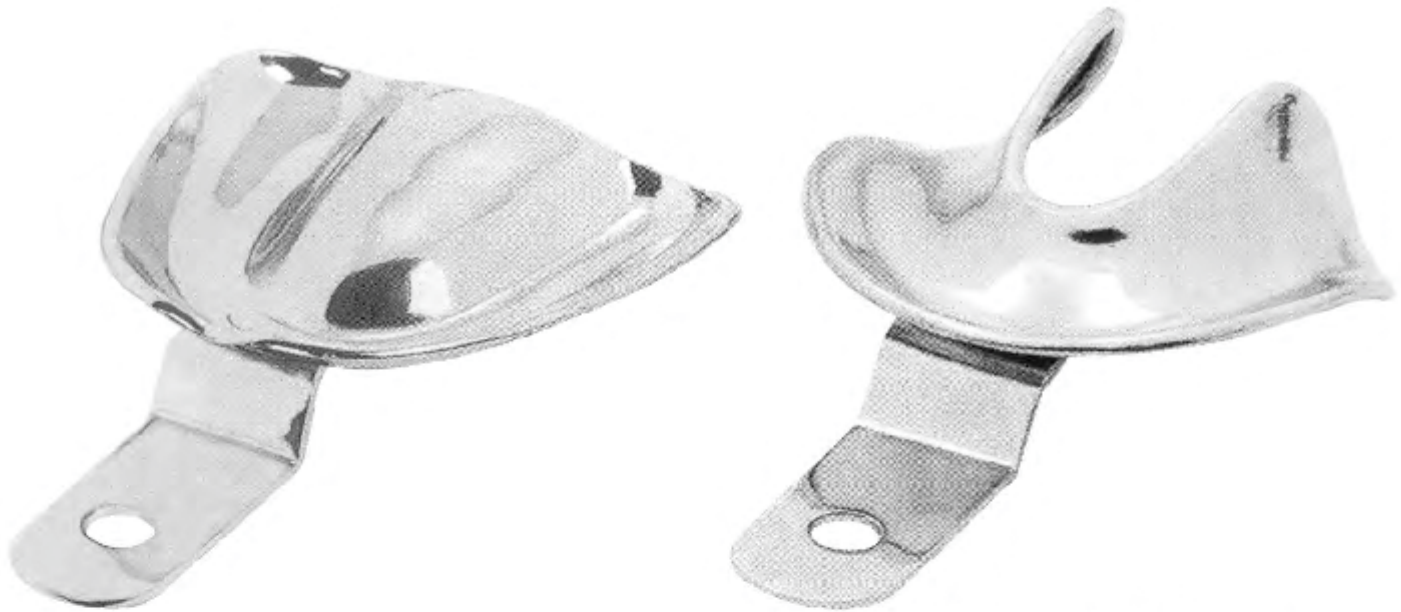

Solid total denture stainless steel impression trays with rim.

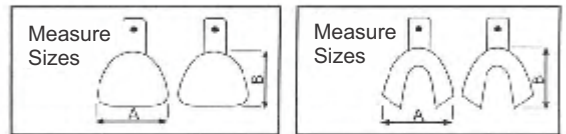

FM-80-4288

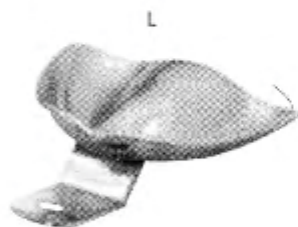

FM-80-4289

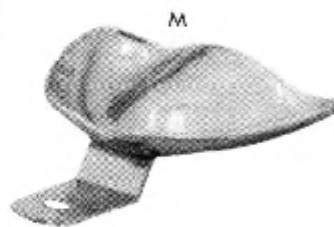

FM-80-4290

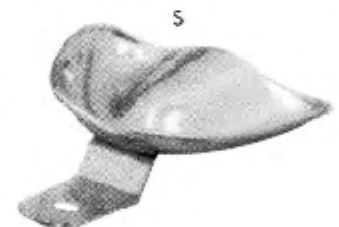

FM-80-4291



FM-80-4292



FM-80-4293



FM-80-4294

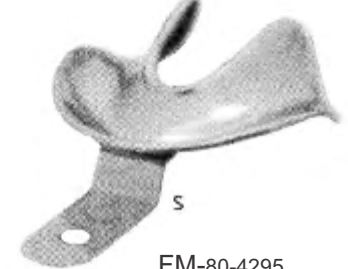

FM-80-4295

		A mm.	B mm.
FM-80-4288	XL	79	70
FM-80-4289	L	76	67
FM-80-4290	M	70	64
FM-80-4291	S	73	60

		A mm.	B mm.
FM-80-4292	XL	86	64
FM-80-4293	L	70	61
FM-80-4294	M	73	60
FM-80-4295	S	70	57

Impression Trays	EN
Knochenfeilen	DE
Limes à os	ES
Plateaux d'impression	FR
Vassoi per le impressioni	IT

80



FAIZAN & MUSA
SURGICAL

IMPRESSION TRAYS



U18

FM-80-4296



U17

FM-80-4297



U16

FM-80-4298



U15

FM-80-4299



L18

FM-80-4300



L17

FM-80-4301



L16

FM-80-4302



L15

FM-80-4303



U24

FM-80-4304



U23

FM-80-4305



U22

FM-80-4306



U21

FM-80-4307



L24

FM-80-4308



L23

FM-80-4309



L22

FM-80-4310



L21

FM-80-4311

EN	Impression Trays
DE	Knochenfeilen
ES	Limes à os
FR	Plateaux d'impression
IT	Vassoi per le impressioni



FAIZAN & MUSA
SURGICAL

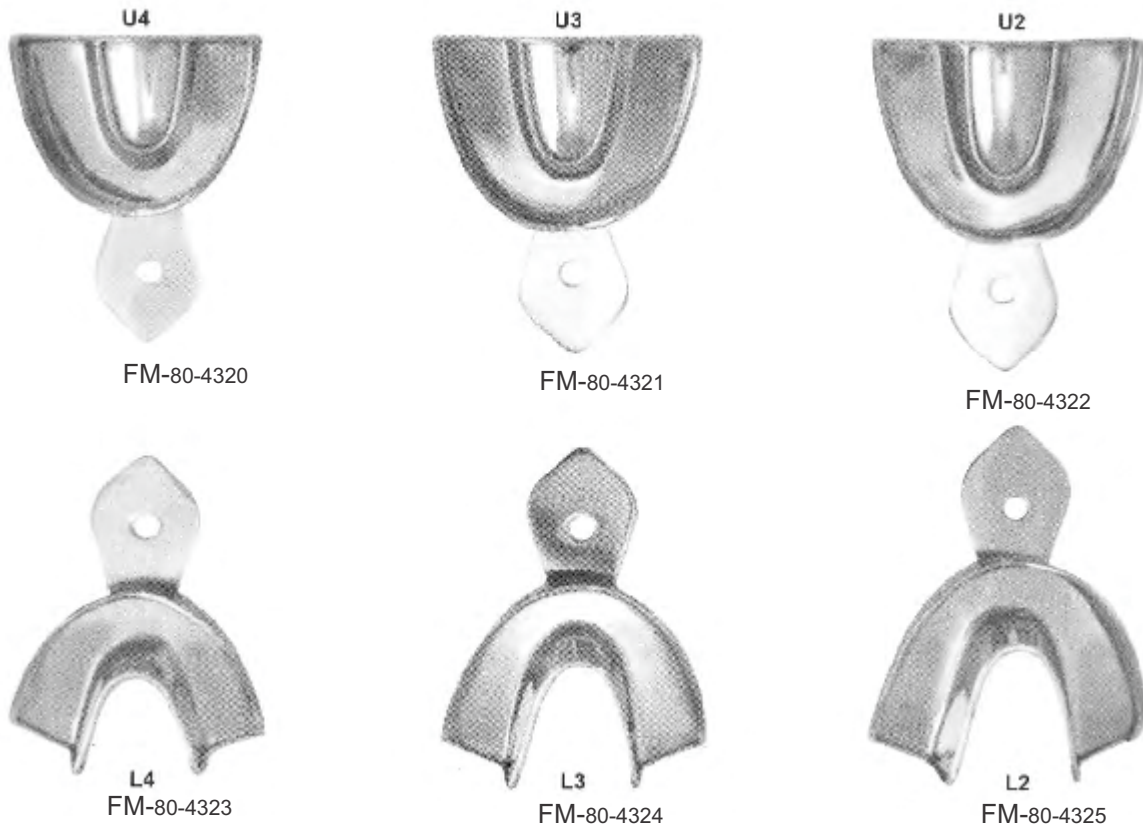
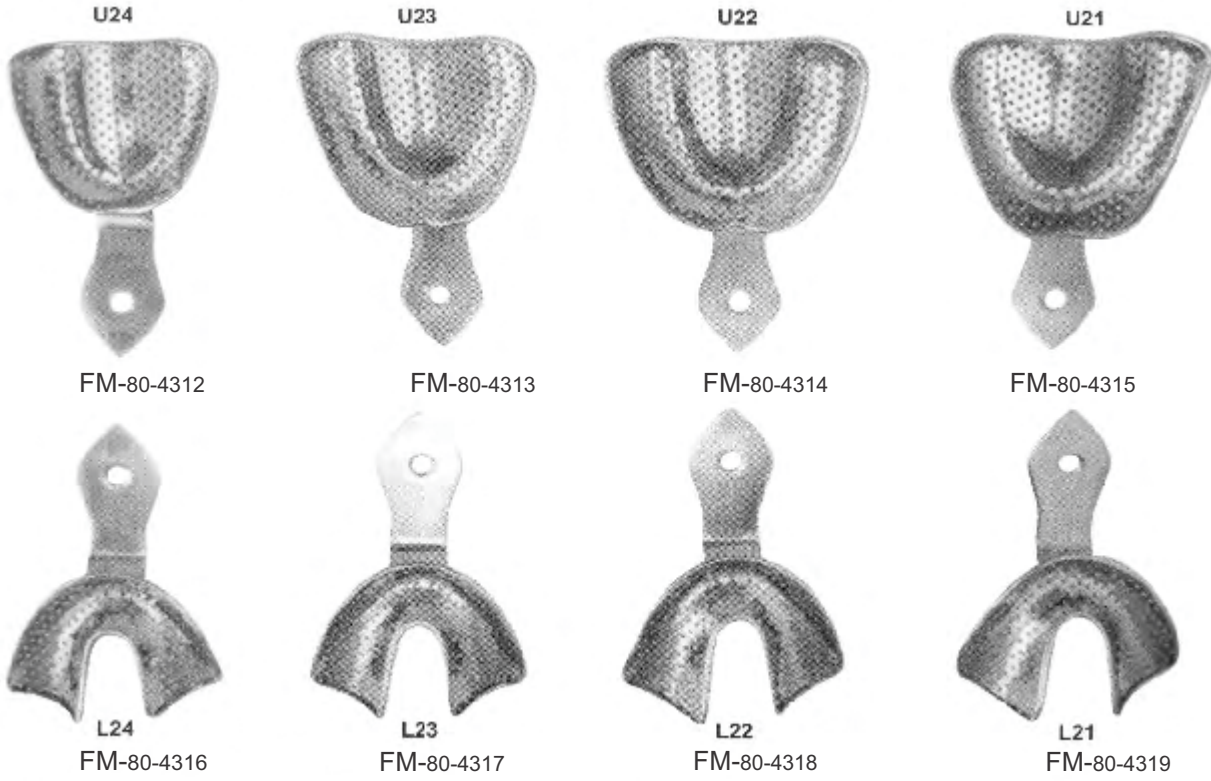

Impression Trays	EN
Knochenfeilen	DE
Limes à os	ES
Plateaux d'impression	FR
Vassoi per le impressioni	IT



FAIZAN & MUSA
SURGICAL

IMPRESSION TRAYS



U4
FM-80-4326



U3
FM-80-4327



U2
FM-80-4328



L4
FM-80-4329



L3
FM-80-4330



L2
FM-80-4331



U15
FM-80-4332



U16
FM-80-4333



U17
FM-80-4334



U18
FM-80-4335



L15
FM-80-4336



L16
FM-80-4337



L17
FM-80-4338



L18
FM-80-4339

EN	Articulators
DE	Artikulatoren
ES	Articuladores
FR	Articulateurs
IT	articolatori

Page 229 to 230



EN	Articulators
DE	Artikulatoren
ES	Articuladores
FR	Articulateurs
IT	articulatori

ARTICULATORS



FM-81-4301



FM-81-4302



FM-81-4303



FM-81-4304



FM-81-4306



FM-81-4305

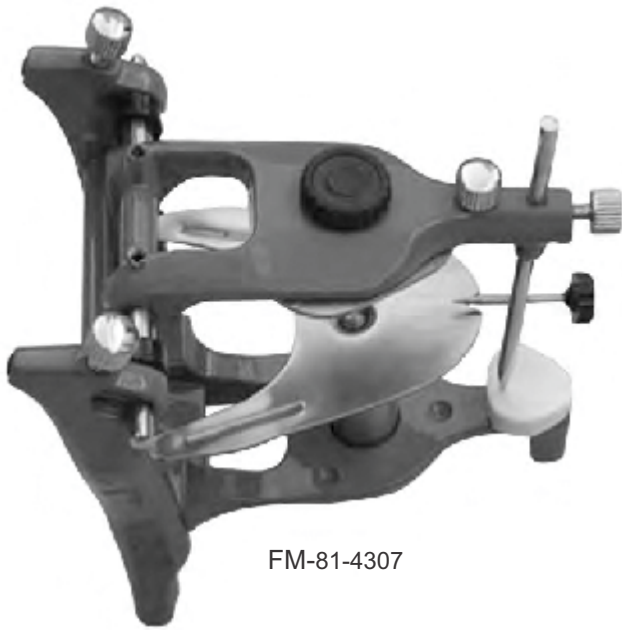

FM-81-4307



FM-81-4308



FM-81-4309



FM-81-4310



FM-81-4312



FM-81-4311

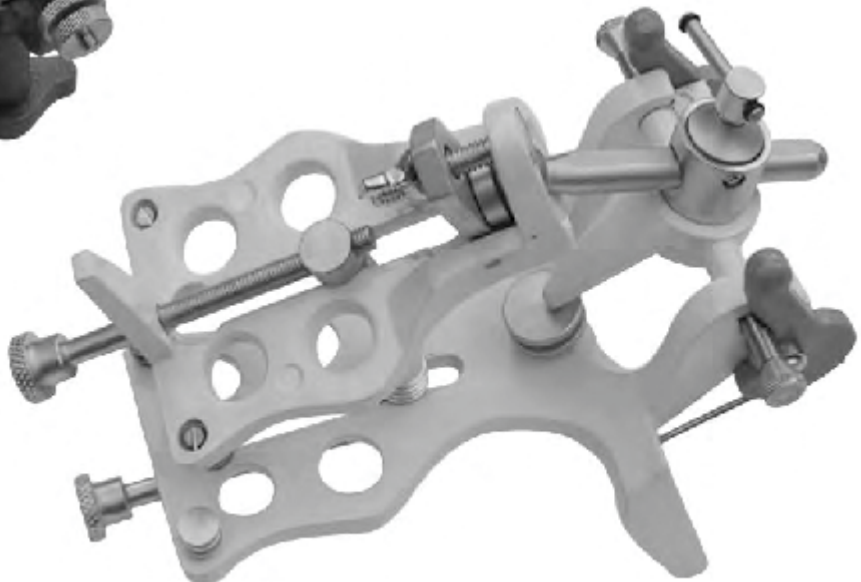

FM-81-4313



**FAIZAN & MUSA
SURGICAL**



**Address:
Aulakh Jattan P.O. Ugoki Sialkot Pakistan**

**Cell#:
+92 328 6284345**

**Email:
info@fm-surgical.com**

**Web:
www.fm-surgical.com**