

LARYNGOSOPES INSTRUMENTS

ENT PRODUCTS

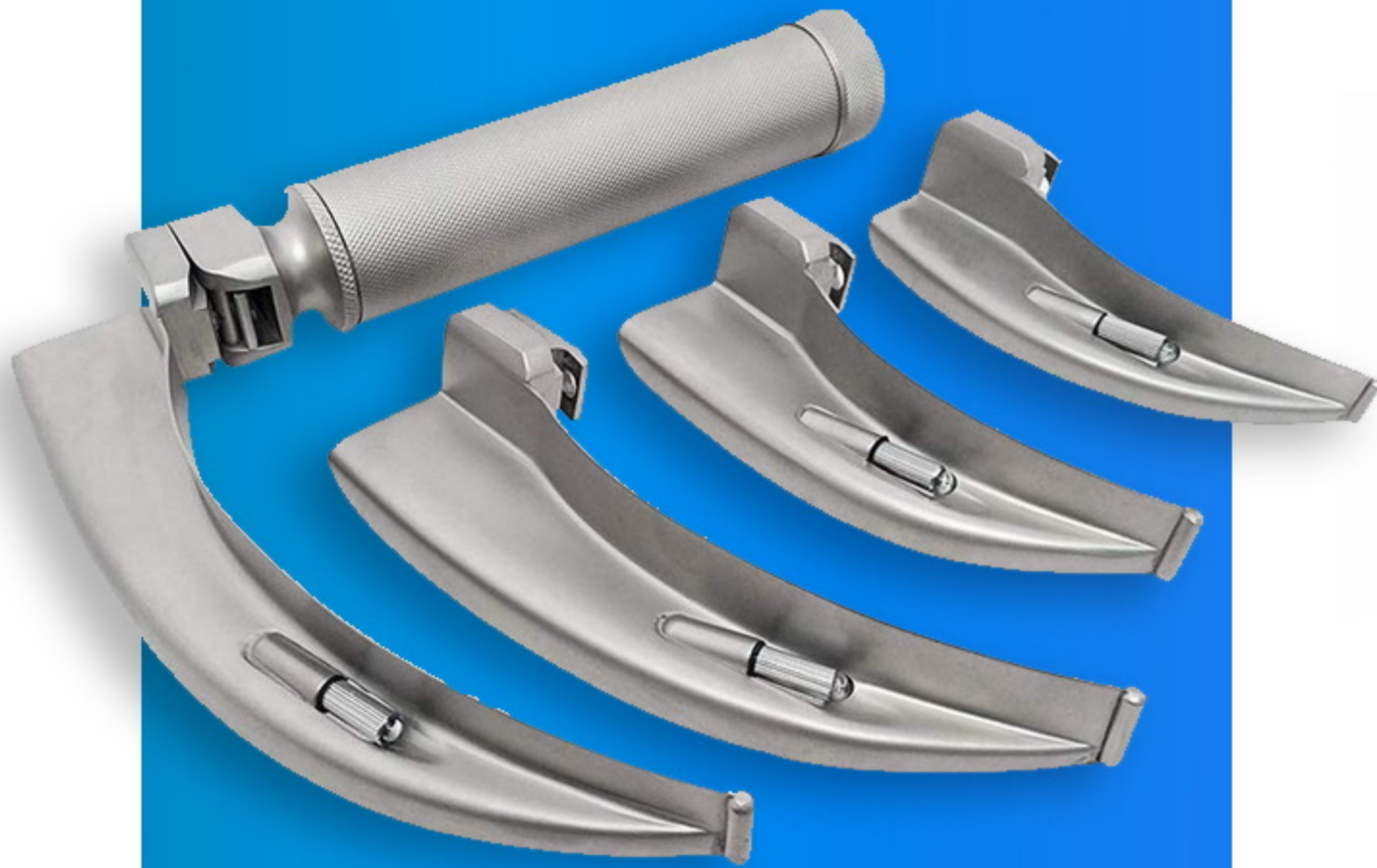

FAIZAN & MUSA SURGICAL INSTRUMENTS



OEM

ORIGINAL | EQUIPMENTS | MANUFACTURER

ODM

ORIGINAL | DESIGN | MANUFACTURER



FLEXIBLE TIP FIBER OPTIC (F.O) LARYNGOSCOPE



FAIZAN & MUSA
SURGICAL INSTRUMENTS

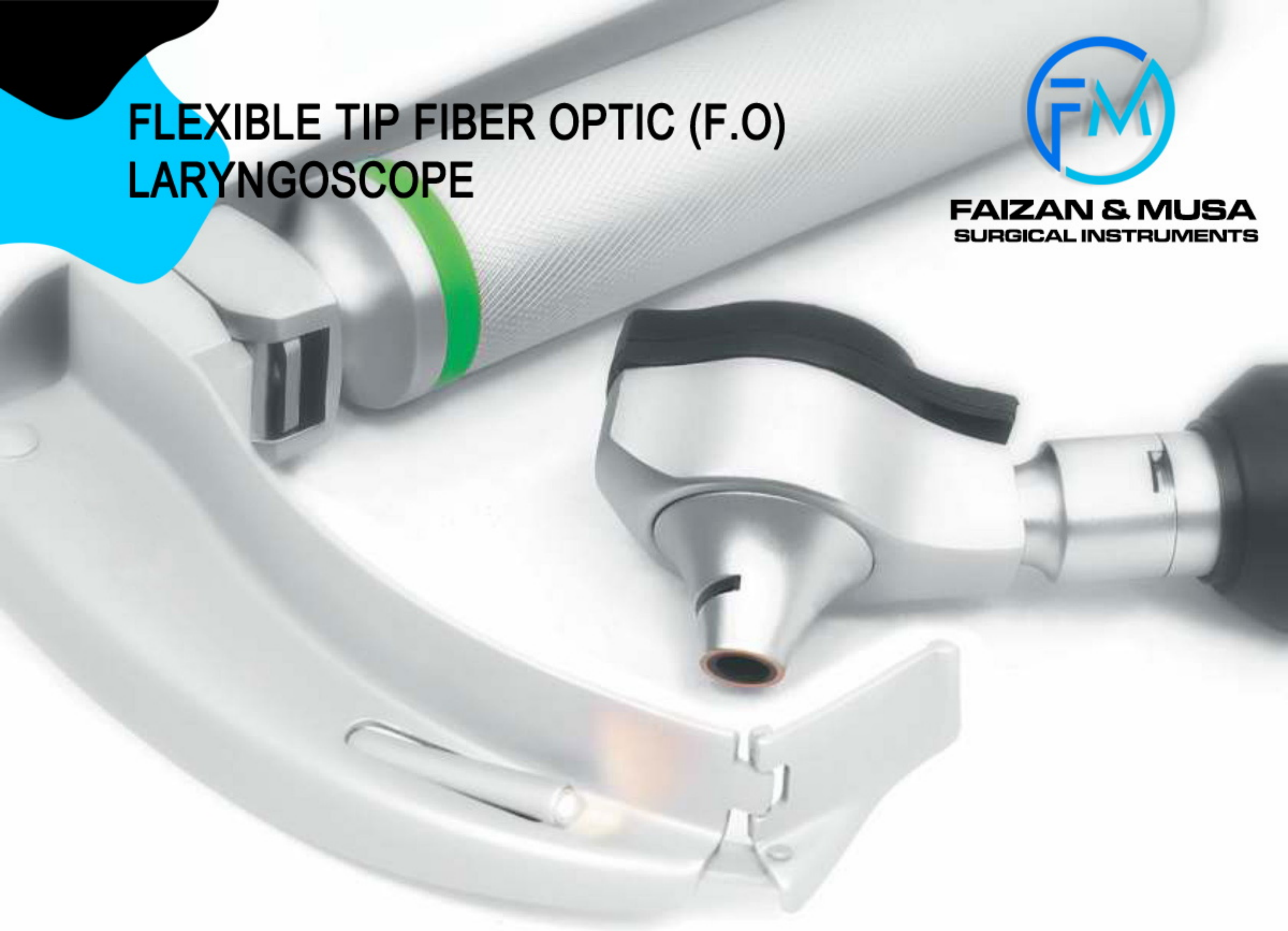

About Us

FAIZAN & MUSA SURGICAL INSTRUMENTS is one of the leading, specialized & advance company manufacturing Laryngoscope Otoscope in Pakistan with very high quality instruments at the prices which are surely reasonable that you might need as a distributor of the instruments to deal your competitive target markets for your business' success

Products And Services

We manufacture a wide range of Laryngoscope, Diagnostic Set and Instruments. We also offer our services to produce any specific instrument for our valued customers.

Dedication to Quality

We assure you of superb services and individual attention at all times. Our policy is to achieve excellence through quality performance in meeting our customers' requirements. Throughout the whole production process quality is maintained by watchful in-line supervision and regular and final inspection. Our production units employ the highest quality of raw materials from Pakistan, Germany, France and Japan.

These Certificates guarantee that our instruments are safe and fit for their intended use.

FLEXIBLE TIP FIBER OPTIC (F.O) LARYNGOSCOPE



FAIZAN & MUSA
SURGICAL INSTRUMENTS



LED LARYNGOSCOPES

Whiteness
Brightness
Durability

FLEXIBLE TIP FIBER OPTIC (F.O.) LARYNGOSCOPE

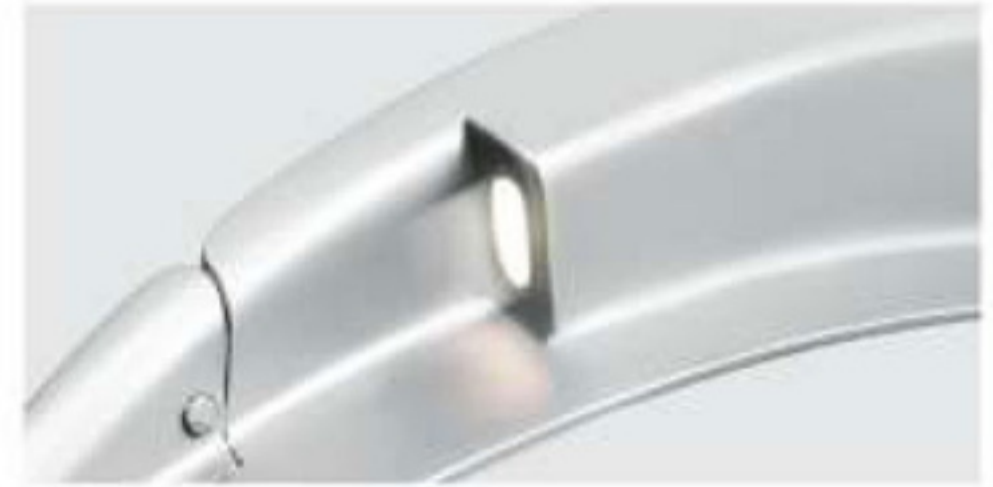

4 x 6 mm MEGA LIGHT



Fiber Optic Handle

Flexible Tip Fiber Optic (F.O.) Laryngoscope Blade MEGA LIGHT

This Flexible Tip Blade is a Macintosh Laryngoscope Blade with a tip which is adjustable through 90°. A lever controls the tip angle during intubation to lift the epiglottis, giving a clear view of the vocal cords. 6500 individual micro-fibers in a 4 X 6 mm Fiber Optic Bundle improve light transmission and longer life.

- Outstanding light intensity with LED illumination through extra strong fiber bundle.
- Swiveling blade tip facilitates difficult intubation.
- Reduced likelihood of damage to teeth and soft tissues.
- Reduce the force required to visualize the Larynx.
- 303/304 type high grade Stainless Steel with Satin Finish.
- Fully autoclavable and easier to clean.
- Fiber Optic handle Requires 2 X C size batteries.
- According to ISO 7376 Standard.



Back view



Front view

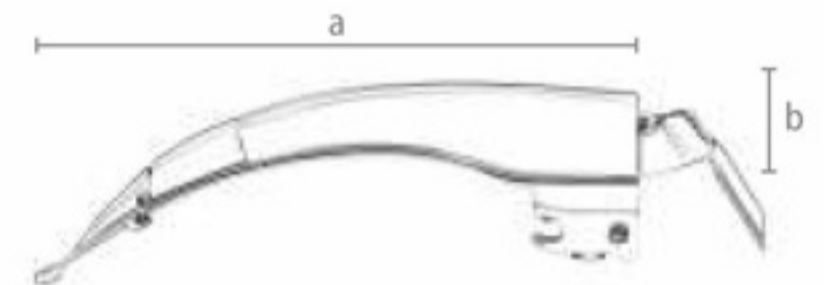

| Flexible Tip Fiber Optic (F.O.) Laryngoscope Blade | | | |
|--|---------------------|--------|--------|
| Size | Blade Reference no. | Length | |
| | | a (mm) | b (mm) |
| 1 | SI-100-01 | 95 | 18 |
| 2 | SI-100-02 | 112 | 18 |
| 3 | SI-100-03 | 135 | 19 |
| 4 | SI-100-04 | 155 | 22 |

FLEXIBLE TIP FIBER OPTIC (F.O.) LARYNGOSCOPE



3 mm FIBER OPTIC LIGHT



Fiber Optic Handle

Flexible Tip Fiber Optic (F.O.) Laryngoscope Blade FIBER OPTIC LIGHT

This Flexible Tip Blade is a Macintosh Laryngoscope Blade with a tip which is adjustable through 90°. A lever controls the tip angle during intubation to lift the epiglottis, giving a clear view of the vocal cords. 5000 individual micro-fibers in 3 mm Fiber Optic tube improve light transmission and longer life.

- Outstanding light intensity with LED illumination through extra strong fiber bundle.
- Swiveling blade tip facilitates difficult intubation.
- Reduced likelihood of damage to teeth and soft tissues.
- Reduce the force required to visualize the Larynx.
- 303/304 type high grade Stainless Steel with Satin Finish.
- Fully autoclavable and easier to clean.
- Fiber Optic handle Requires 2 X C size batteries.
- According to ISO 7376 Standard.



Back view



Front view

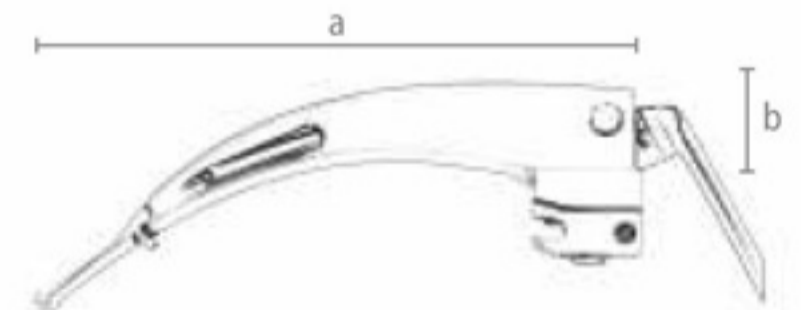

| Flexible Tip Fiber Optic (F.O.) Laryngoscope Blade | | | |
|--|---------------------|--------|--------|
| Size | Blade Reference no. | Length | |
| | | a (mm) | b (mm) |
| 1 | SI-105-01 | 93 | 19 |
| 2 | SI-105-02 | 112 | 19 |
| 3 | SI-105-03 | 132 | 22 |
| 4 | SI-105-04 | 155 | 24 |

FLEXIBLE TIP FIBER OPTIC (F.O) LARYNGOSCOPE



Conventional Handle



LED LAMP

Flexible Tip Conventional Laryngoscope Blade LED LAMP

The Flexible Tip is a Macintosh Laryngoscope Blade with a tip which is adjustable through 90°. A lever controls the tip angle during intubation to lift the epiglottis, giving a clear view of the vocal cords.

- Outstanding Light Intensity with LED Illumination.
- Swivelling blade tip facilitates difficult intubation.
- Reduced likelihood of damage to teeth and soft tissue.
- Rounded tip and smooth edges.
- 303/304 surgical stainless steel with satin finish.
- Fully autoclavable and easier to clean.
- Conventional handle Requires 2 X C size batteries.
- According to ISO 7376 Standard.



Back view



Front view

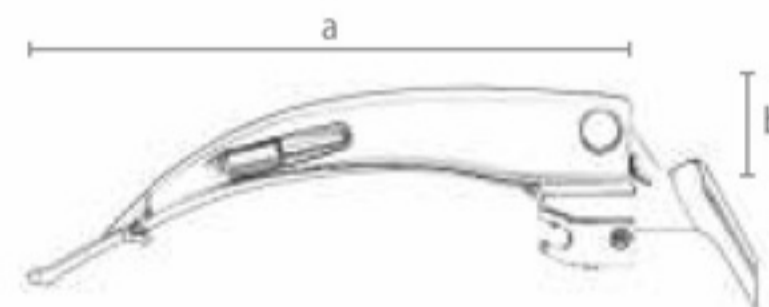

| Flexible Tip Conventional Laryngoscope Blade | | | |
|--|---------------------|--------|--------|
| Size | Blade Reference no. | Length | |
| | | a (mm) | b (mm) |
| 1 | SI-110-01 | 93 | 19 |
| 2 | SI-110-02 | 112 | 19 |
| 3 | SI-110-03 | 132 | 22 |
| 4 | SI-110-04 | 155 | 24 |

FLEXIBLE TIP FIBER OPTIC (F.O.) LARYNGOSCOPE



4 mm LIT LIGHT



Disposable
Fiber Optic Handle

Flexible Tip Disposable Fiber Optic (F.O.) Laryngoscope Blade LIT LIGHT

The Flexible Tip is a Macintosh Laryngoscope Blade with a tip which is adjustable through 90°. This blade, with 4 mm plastic end LIT Fiber Optic, is processed from plastic Fiber Optic. We coat a plastic PVC jacket to protect inner fiber for working well, keep it longer life and get more brightness from Illuminator.

- 304 type high grade Stainless Steel with Plastic Heel, Satin Finish.
- Flexible Fiber optic Tube with black sleeve 5mm LIT Light for improved light transmission.
- Swiveling blade tip facilitates difficult intubation.
- Reduced likelihood of damage to teeth and soft tissues.
- Disposable fiber optic Silver handle with powder coating.
- Disposable handle Requires 3 X Lithium 123 batteries.
- According to ISO 7376 Standard.



Back view

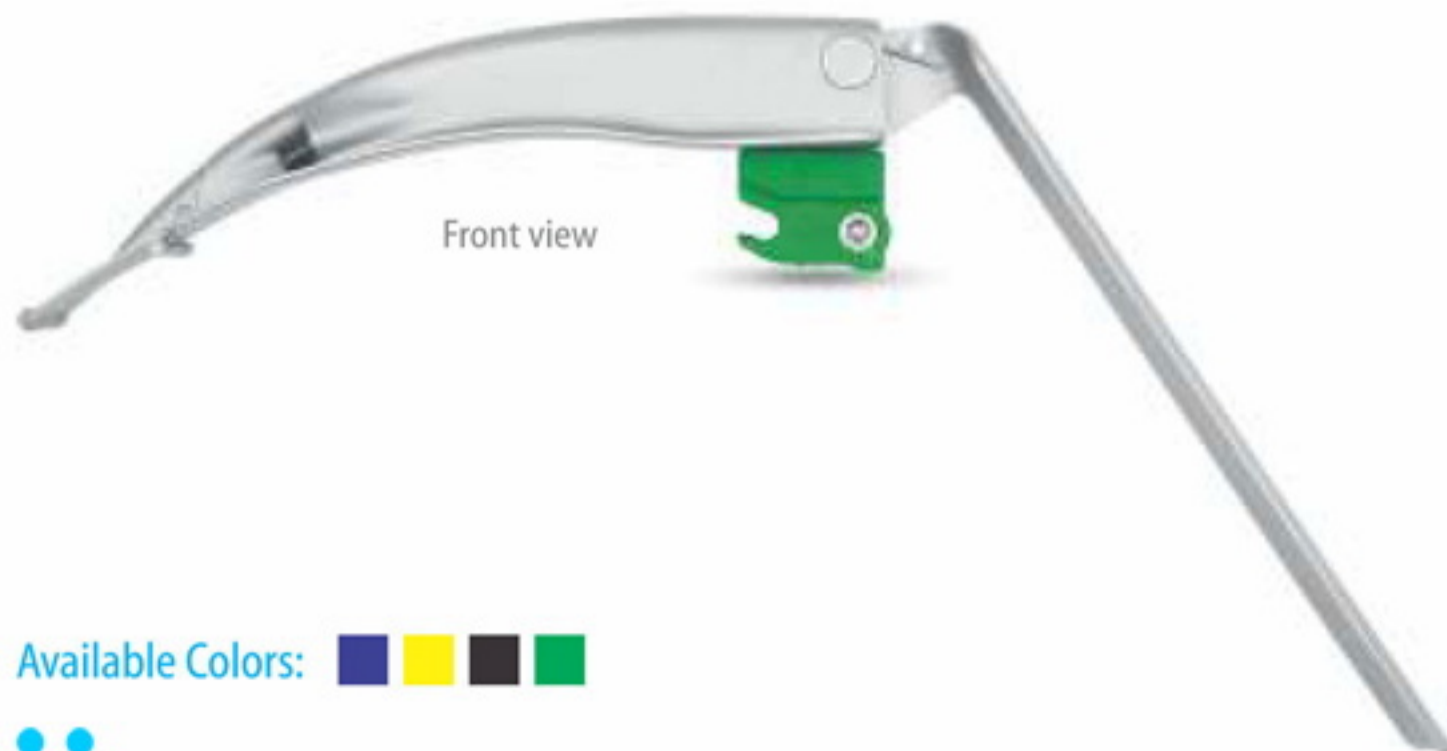

Front view

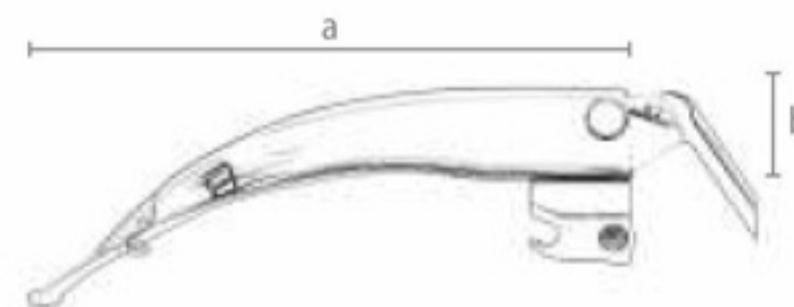

| Flexible Tip Disposable Fiber Optic (F.O.) Laryngoscope Blade | | | |
|---|------------------------|--------|--------|
| Size | Blade Reference no. | Length | |
| | | a (mm) | b (mm) |
| 1 | SI-115-01 | 100 | 18 |
| 2 | SI-115-02 | 113 | 18 |
| 3 | SI-115-03 | 135 | 21 |
| 4 | SI-115-04 | 155 | 21 |

Available Colors: 

FLEXIBLE TIP FIBER OPTIC (F.O) LARYNGOSCOPE



3 mm LED LIGHT



Disposable
Conventional Handle

Flexible Tip Disposable Fiber Optic (F.O.) Laryngoscope Blade LED LIGHT

This Flexible Tip Blade is a Macintosh Laryngoscope Blade with a tip which is adjustable through 90°. A lever controls the tip angle during intubation to lift the epiglottis, giving a clear view of the vocal cords.

- Unbreakable Plastic base with Disposable Surgical Stainless Steel blade.
- Single use conventional Flexible tip blade with LED light.
- Swiveling blade tip facilitates difficult intubation.
- Reduced likelihood of damage to teeth and soft tissues.
- Reduce the force required to visualize the Larynx.
- Disposable fiber optic Silver handle with powder coating
- Handle Requires 3 X Lithium 123 batteries.
- According to ISO 7376 Standard.



Back view

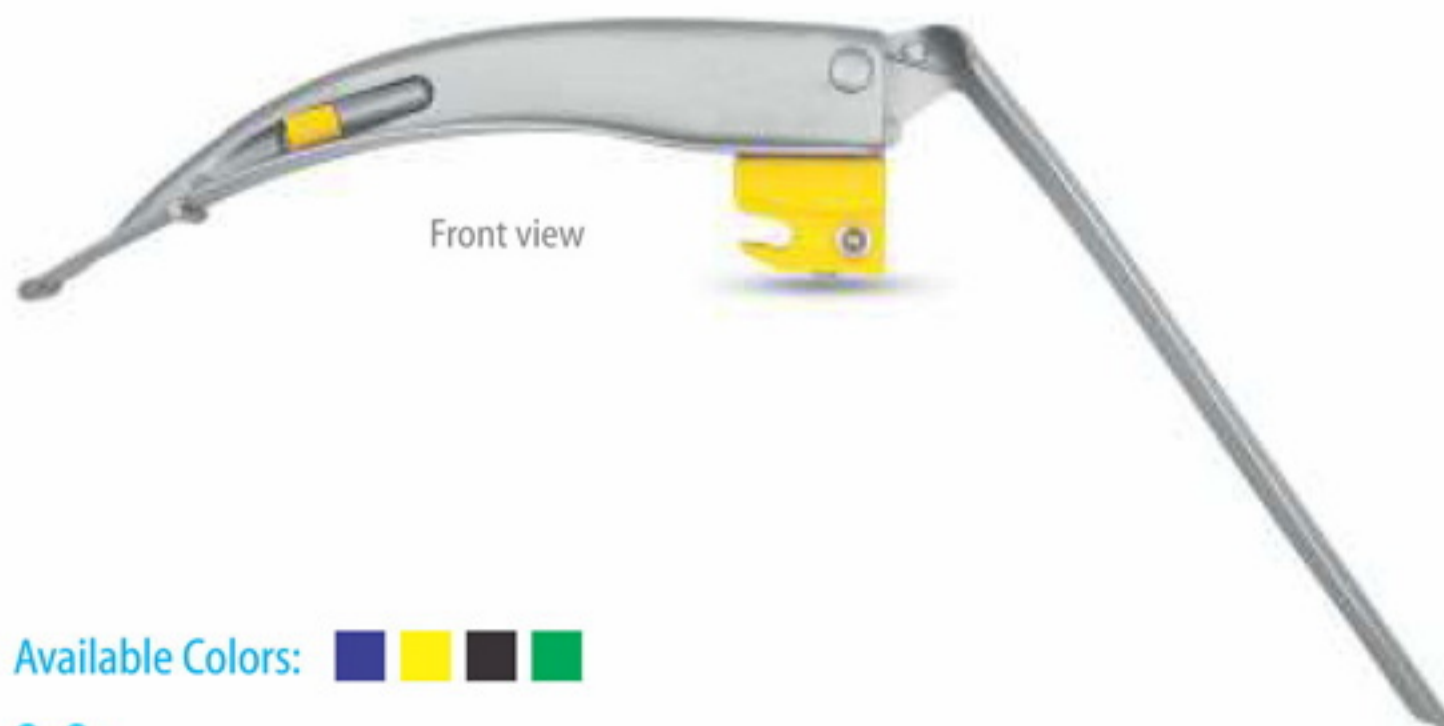

Front view

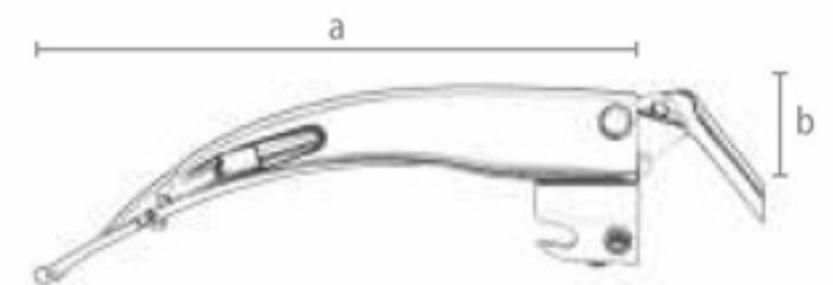

| Flexible Tip Disposable Conventional Laryngoscope Blade | | | |
|---|------------------------|--------|--------|
| Size | Blade Reference no. | Length | |
| | | a (mm) | b (mm) |
| 1 | SI-120-01 | 100 | 18 |
| 2 | SI-120-02 | 113 | 18 |
| 3 | SI-120-03 | 135 | 21 |
| 4 | SI-120-04 | 155 | 21 |

Available Colors: 

FLEXIBLE TIP FIBER OPTIC (F.O) LARYNGOSCOPE



Fiber Optic Handle

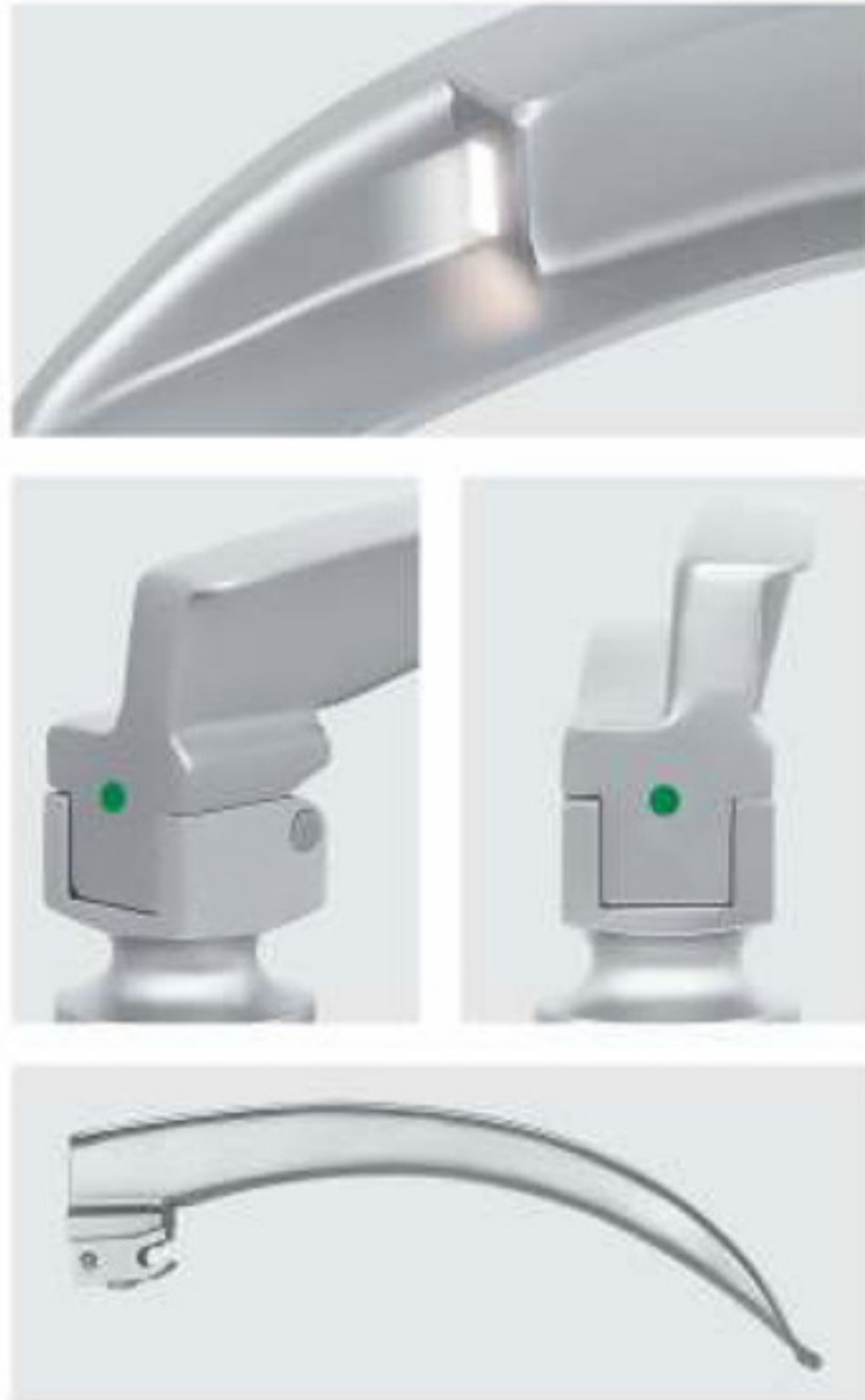

Fiber Optic (F.O.) Laryngoscope Blade MEGA LIGHT

Macintosh Mega Light Laryngoscope blade with 4 x 6 mm and up to 6500 individual micro-fibers for improved light transmission and longer life.

- 303/304 type high grade Stainless Steel with Satin Finish.
- Smooth shape avoids sharp edges and cavities for easy cleaning and sterilizing.
- Integrated Fiber Optics for the best possible illumination.
- Compatible with all standard Fiber Optic handles.
- Fully autoclavable and easier to clean.
- Fiber Optic handle with LED light.
- According to ISO 7376 standard.

Power Source

- All our Fiber Optic handles are powered by Standard battery handle: 2" C" size
- Pediatric battery handle: 2" AA" size
- Stubby battery handle: 2" AA" size

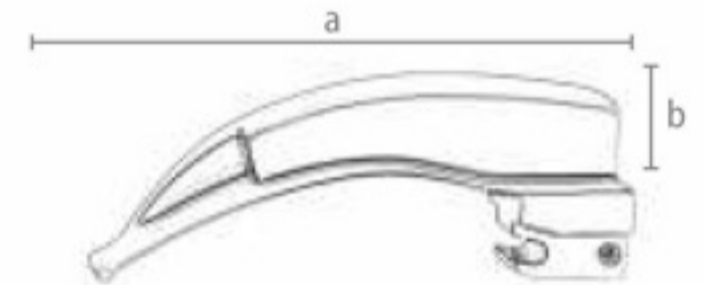

| Fiber Optic (F.O.) Laryngoscope Blade. (Mega Blade) | | | |
|---|-----------|---------------|--------|
| Size | Blade | Length | |
| | | Reference no. | a (mm) |
| 1 | SI-200-01 | 97 | 18 |
| 2 | SI-200-02 | 114 | 18 |
| 3 | SI-200-03 | 137 | 19 |
| 4 | SI-200-04 | 157 | 22 |

| Fiber Optic (F.O.) Laryngoscope Sets. (Mega Blade) | |
|--|-------------------------------------|
| Reference no. | Description |
| SI-200-10 | 2 Blades + 1 Handle in Plastic Box. |
| SI-200-20 | 3 Blades + 1 Handle in Plastic Box. |
| SI-200-30 | 4 Blades + 1 Handle in Plastic Box. |

FLEXIBLE TIP FIBER OPTIC (F.O) LARYNGOSCOPE



Fiber Optic Handle



Fiber Optic (F.O.) Laryngoscope Blade INTERCHANGEABLE LIGHT CONDUCTOR

Macintosh Fiber Optic laryngoscope blade with 4mm F.O light conductor, up to 6500 individual micro-fibers for improved light transmission and longer life.

- Blade with Removable light conductor which is simple to remove and refit without any tool.
- Integrated Fiber optic for the best Possible Illumination.
- 303/304 type high grade Stainless Steel with Satin Finish.
- Smooth shape avoids sharp edges.
- Fully autoclavable and easier to clean.
- Compatible with all Standard Fiber optic handles.
- Fiber optic Handle with LED light.
- According to ISO 7376 Standard.

Power Source

- All our Fiber Optic handles are powered by Standard battery handle: 2" C" size
- Pediatric battery handle: 2" AA" size
- Stubby battery handle: 2" AA" size

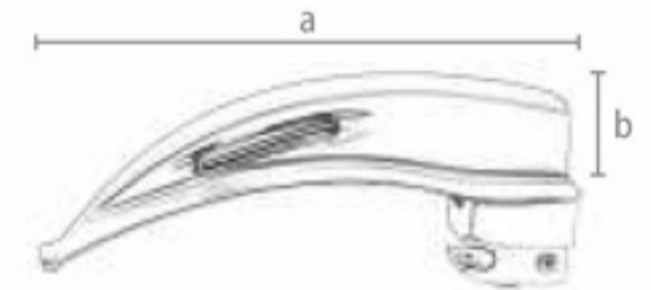

Macintosh Fiber Optic (F.O.) Laryngoscope Blades. (Interchangeable)

| Size | Blade Reference no. | Length | |
|------|---------------------|--------|--------|
| | | a (mm) | b (mm) |
| 1 | SI-205-01 | 102 | 18 |
| 2 | SI-205-02 | 115 | 18 |
| 3 | SI-205-03 | 137 | 21 |
| 4 | SI-205-04 | 157 | 21 |

Macintosh Fiber Optic (F.O.) Laryngoscope Sets. (Interchangeable)

| Reference no. | Description |
|---------------|-------------------------------------|
| SI-205-10 | 2 Blades + 1 Handle in Plastic Box. |
| SI-205-20 | 3 Blades + 1 Handle in Plastic Box. |
| SI-205-30 | 4 Blades + 1 Handle in Plastic Box. |

FLEXIBLE TIP FIBER OPTIC (F.O.) LARYNGOSCOPE



Fiber Optic Handle



Fiber Optic (F.O.) Laryngoscope Blade INTERCHANGEABLE LIGHT CONDUCTOR

Miller Fiber Optic laryngoscope blade with 4mm F.O light conductor, up to 6500 individual micro-fibers for improved light transmission and longer life.

- Blade with Removable light conductor which is simple to remove and refit without any tool.
- Integrated Fiber optic for the best Possible Illumination.
- 303/304 type high grade Stainless Steel with Satin Finish.
- Smooth shape avoids sharp edges.
- Fully autoclavable and easier to clean.
- Compatible with all Standard Fiber optic handles.
- Fiber optic Handle with LED light.
- According to ISO 7376 Standard.

Power Source

- All our Fiber Optic handles are powered by
- Standard battery handle: 2" C" size
- Pediatric battery handle: 2" AA" size
- Stubby battery handle: 2" AA" size

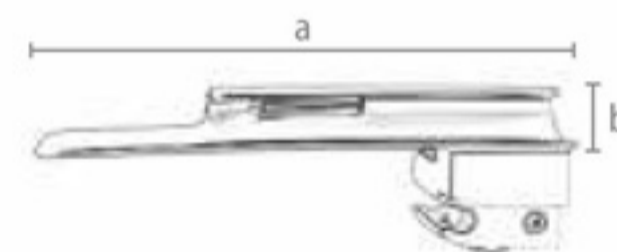

Miller Fiber Optic (F.O.) Laryngoscope Blades. (Interchangeable)

| Size | Blade Reference no. | Length | |
|------|---------------------|--------|--------|
| | | a (mm) | b (mm) |
| 00 | SI-210-00 | 70 | 12 |
| 0 | SI-210-0 | 78 | 12 |
| 1 | SI-210-01 | 105 | 12 |
| 2 | SI-210-02 | 155 | 13 |
| 3 | SI-210-03 | 195 | 13 |
| 4 | SI-210-04 | 204 | 15 |

Miller Fiber Optic (F.O.) Laryngoscope Sets. (Interchangeable)

| Reference no. | Description |
|---------------|-------------------------------------|
| SI-210-10 | 3 Blades + 1 Handle in Plastic Box. |
| SI-210-20 | 4 Blades + 1 Handle in Plastic Box. |
| SI-210-30 | 5 Blades + 1 Handle in Plastic Box. |

FLEXIBLE TIP FIBER OPTIC (F.O) LARYNGOSCOPE



Fiber Optic Handle



Fiber Optic (F.O.) Laryngoscope Blade FIX TUBE

Macintosh Fiber Optic laryngoscope blade with 4mm F.O light conductor, up to 6500 individual micro-fibers for improved light transmission and longer life.

- :- Blade with Fixed Fiberoptic light conductor.
- :- Integrated Fiber optic for the best Possible Illumination.
- :- 303/304 type high grade Stainless Steel with Satin Finish.
- :- Smooth shape avoids sharp edges.
- :- Fully autoclavable and easier to clean.
- :- Compatible with all Standard Fiber optic handles.
- :- Fiber optic Handle with LED light.
- :- According to ISO 7376 standard.

Power Source

- :- All our Fiber Optic handles are powered by
- Standard battery handle: 2" C" size
- Pediatric battery handle: 2" AA" size
- Stubby battery handle: 2" AA" size

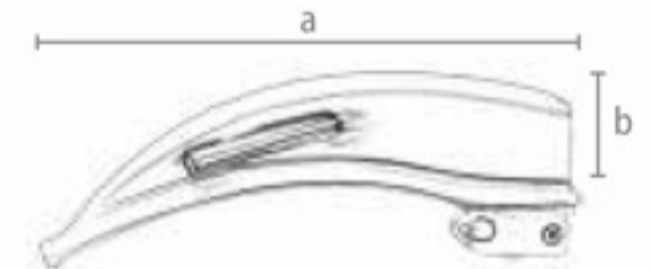

| Macintosh Fiber Optic (F.O.) Laryngoscope Blades. (Fix Tube) | | | |
|--|---------------------|--------|--------|
| Size | Blade Reference no. | Length | |
| | | a (mm) | b (mm) |
| 1 | SI-215-01 | 102 | 18 |
| 2 | SI-215-02 | 115 | 18 |
| 3 | SI-215-03 | 137 | 21 |
| 4 | SI-215-04 | 157 | 21 |

| Macintosh Fiber Optic (F.O.) Laryngoscope Sets. (Fix Tube) | |
|--|-------------------------------------|
| Reference no. | Description |
| SI-215-10 | 2 Blades + 1 Handle in Plastic Box. |
| SI-215-20 | 3 Blades + 1 Handle in Plastic Box. |
| SI-215-30 | 4 Blades + 1 Handle in Plastic Box. |

MILLER FIBER OPTIC (F.O) LARYNGOSCOPE



Fiber Optic Handle



Fiber Optic (F.O.) Laryngoscope Blade FIX TUBE

Miller Fiber Optic laryngoscope blade with 4mm F.O light conductor, up to 6500 individual micro-fibers for improved light transmission and longer life.

- Blade with Fixed Fiberoptic light conductor.
- Integrated Fiber optic for the best Possible Illumination.
- 303/304 type high grade Stainless Steel with Satin Finish.
- Smooth shape avoids sharp edges.
- Fully autoclavable and easier to clean.
- Compatible with all Standard Fiber optic handles.
- Fiber optic Handle with LED light.
- According to ISO 7376 standard.

Power Source

- All our Fiber Optic handles are powered by
- Standard battery handle: 2" C" size
- Pediatric battery handle: 2" AA" size
- Stubby battery handle: 2" AA" size

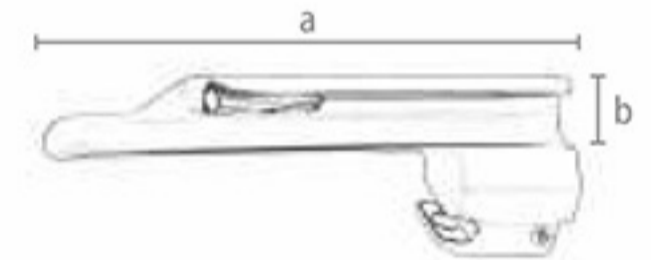

| Miller Fiber Optic (F.O.) Laryngoscope Blades. (Fix Tube) | | | |
|---|---------------------|--------|--------|
| Size | Blade Reference no. | Length | |
| | | a (mm) | b (mm) |
| 00 | SI-220-00 | 70 | 12 |
| 0 | SI-220-0 | 78 | 12 |
| 1 | SI-220-01 | 105 | 12 |
| 2 | SI-220-02 | 155 | 13 |
| 3 | SI-220-03 | 195 | 13 |
| 4 | SI-220-04 | 204 | 15 |

| Miller Fiber Optic (F.O.) Laryngoscope Sets. (Fix Tube) | |
|---|-------------------------------------|
| Reference no. | Description |
| SI-220-10 | 3 Blades + 1 Handle in Plastic Box. |
| SI-220-20 | 4 Blades + 1 Handle in Plastic Box. |
| SI-220-30 | 5 Blades + 1 Handle in Plastic Box. |

MACINTOSH CONVENTIONAL LARYNGOSCOPE



Conventional Handle



Conventional Laryngoscope Blade LED BULB

Macintosh Conventional Laryngoscope Blade with LED Bulb. The light bulb in the blade can easily be changed.

- Outstanding light intensity with LED illumination.
- 303/304 type high grade Stainless Steel.
- Satin finish laryngoscope blade reduces glare, ensures safer intubations
- Smooth knurled Handle provides grip without risk of tearing gloves.
- Fully autoclavable and easier to clean.
- According to ISO 7376 Standard.

Power Source

- All our Conventional handles are powered by
- Standard battery handle: 2" C" size
- Pediatric battery handle: 2" AA" size
- Stubby battery handle: 2" AA" size

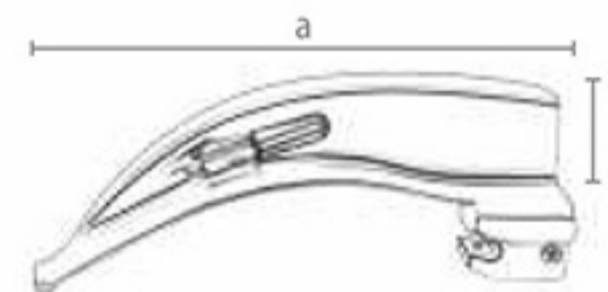

| Macintosh Conventional Laryngoscope Blades. | | | |
|---|---------------------|--------|--------|
| Size | Blade Reference no. | Length | |
| | | a (mm) | b (mm) |
| 0 | SI-225-0 | 82 | 17 |
| 1 | SI-225-1 | 95 | 19 |
| 2 | SI-225-02 | 114 | 19 |
| 3 | SI-225-03 | 134 | 22 |
| 4 | SI-225-04 | 157 | 24 |
| 5 | SI-225-05 | 177 | 24 |

| Macintosh Conventional Laryngoscope Sets. | |
|---|-------------------------------------|
| Reference no. | Description |
| SI-225-10 | 3 Blades + 1 Handle in Plastic Box. |
| SI-225-20 | 4 Blades + 1 Handle in Plastic Box. |
| SI-225-30 | 5 Blades + 1 Handle in Plastic Box. |

MILLER CONVENTIONAL LARYNGOSCOPE



Conventional Handle



Conventional Laryngoscope Blade LED BULB

Miller Conventional Laryngoscope Blade with LED Bulb. The light bulb in the blade can easily be changed.

- Outstanding light intensity with LED illumination.
- 303/304 type high grade Stainless Steel.
- Satin finish laryngoscope blade reduces glare, ensures safer intubations
- Smooth knurled Handle provides grip without risk of tearing gloves.
- Fully autoclavable and easier to clean.
- According to ISO 7376 Standard.

Power Source

- All our Conventional handles are powered by
- Standard battery handle: 2" C" size
- Pediatric battery handle: 2" AA" size
- Stubby battery handle: 2" AA" size

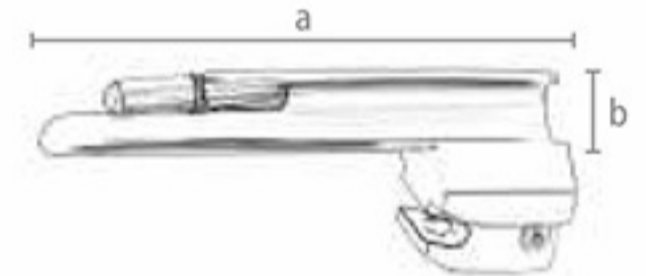

Miller Conventional Laryngoscope Blades.

| Size | Blade Reference no. | Length | |
|------|---------------------|--------|--------|
| | | a (mm) | b (mm) |
| 00 | SI-230-00 | 70 | 12 |
| 0 | SI-230-0 | 78 | 12 |
| 1 | SI-230-01 | 105 | 12 |
| 2 | SI-230-02 | 155 | 13 |
| 3 | SI-230-03 | 195 | 13 |
| 4 | SI-230-04 | 204 | 15 |

Miller Conventional Laryngoscope Sets.

| Reference no. | Description |
|---------------|-------------------------------------|
| SI-230-10 | 3 Blades + 1 Handle in Plastic Box. |
| SI-230-20 | 4 Blades + 1 Handle in Plastic Box. |
| SI-230-30 | 5 Blades + 1 Handle in Plastic Box. |

MACINTOSH CONVENTIONAL LARYNGOSCOPE



Conventional Handle



Conventional Laryngoscope Blade FIXED LED LAMP

Macintosh Conventional Laryngoscope blade with FIXED LED lamp. The light lamp is fixed in the tube and non-changeable.

- Outstanding light intensity with LED illumination.
- 303/304 type high grade Stainless Steel.
- Satin finish laryngoscope blade reduces glare, ensures safer intubations
- Smooth knurled Handle provides grip without risk of tearing gloves.
- Fully autoclavable and easier to clean.
- According to ISO 7376 Standard.

Power Source

- All our Conventional handles are powered by
 - Standard battery handle: 2" C" size
 - Pediatric battery handle: 2" AA" size
 - Stubby battery handle: 2" AA" size

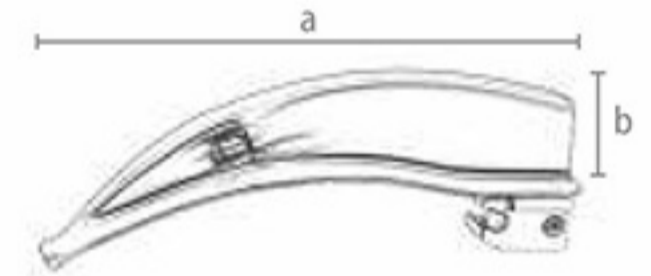

| Macintosh Conventional Laryngoscope Blade. with fixed LED lamp. | | | |
|---|-----------|---------------|--------|
| Size | Blade | Length | |
| | | Reference no. | a (mm) |
| 1 | SI-235-01 | 102 | 18 |
| 2 | SI-235-02 | 115 | 18 |
| 3 | SI-235-03 | 137 | 21 |
| 4 | SI-235-04 | 157 | 21 |

| Macintosh Conventional Laryngoscope Sets. with fixed LED lamp | |
|---|-------------------------------------|
| Reference no. | Description |
| SI-235-10 | 2 Blades + 1 Handle in Plastic Box. |
| SI-235-20 | 3 Blades + 1 Handle in Plastic Box. |
| SI-235-30 | 4 Blades + 1 Handle in Plastic Box. |

MILLER CONVENTIONAL LARYNGOSCOPE



Conventional Handle

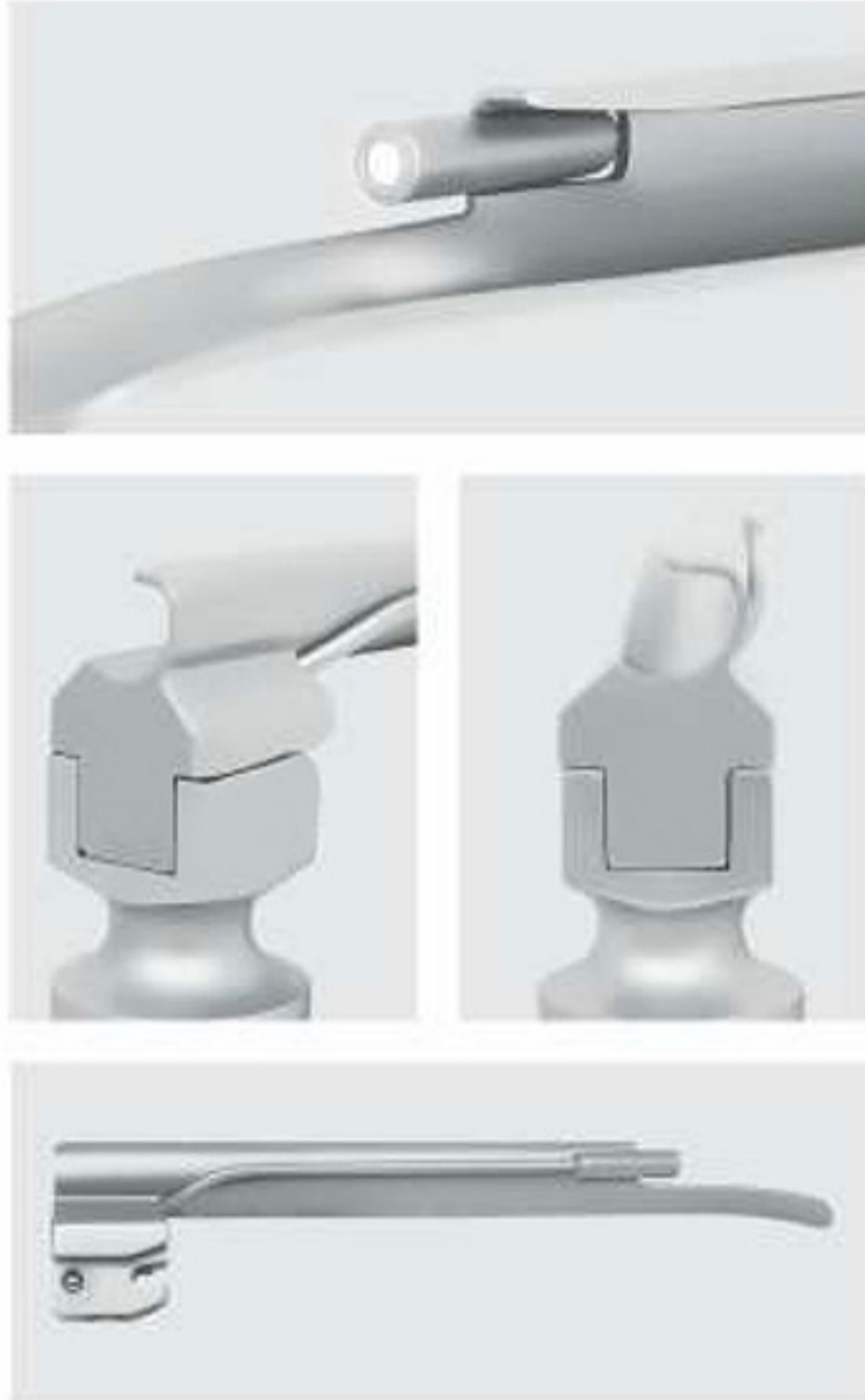

Conventional Laryngoscope Blade FIXED LED LAMP

Miller Conventional Laryngoscope blade with FIXED LED lamp. The light lamp is fixed in the tube and non-changeable.

- Outstanding light intensity with LED illumination.
- 303/304 type high grade Stainless Steel.
- Satin finish laryngoscope blade reduces glare, ensures safer intubations
- Smooth knurled Handle provides grip without risk of tearing gloves.
- Fully autoclavable and easier to clean.
- According to ISO 7376 Standard.

Power Source

- All our Conventional handles are powered by
 - Standard battery handle: 2" C" size
 - Pediatric battery handle: 2" AA" size
 - Stubby battery handle: 2" AA" size

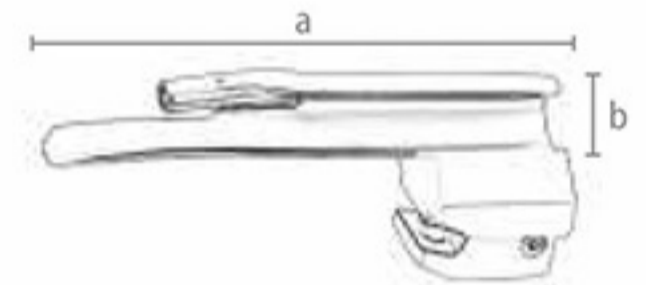

Miller Conventional Laryngoscope Blade. with fixed LED lamp.

| Size | Blade Reference no. | Length | |
|------|------------------------|--------|--------|
| | | a (mm) | b (mm) |
| 00 | SI-240-00 | 70 | 12 |
| 0 | SI-240-0 | 78 | 12 |
| 1 | SI-240-01 | 105 | 12 |
| 2 | SI-240-02 | 155 | 13 |
| 3 | SI-240-03 | 195 | 13 |
| 4 | SI-240-04 | 204 | 15 |

Miller Conventional Laryngoscope Sets. with fixed LED lamp.

| Reference no. | Description |
|---------------|-------------------------------------|
| SI-240-10 | 3 Blades + 1 Handle in Plastic Box. |
| SI-240-20 | 4 Blades + 1 Handle in Plastic Box. |
| SI-240-30 | 5 Blades + 1 Handle in Plastic Box. |

MACINTOSH, DISPOSABLE CONVENTIONAL LARYNGOSCOPE



Dual Lighted Conventional Laryngoscope Blade UV/WHITE LED

Plastic Heel

White and UV LED lighting combination produces optimized high definition viewing area,

- Blade made of 304 type non-magnet stainless steel with plastic heel.
- Smooth shape avoids sharp edges and cavities.
- Compatible with all standard conventional handles.
- Conventional disposable handle made of silver.
- According to ISO 7376 standard.

Power Source

- Watch-size lithium batteries are pre-installed for quick single use, and are easily removed for separate disposal. These Fiber Optic disposable handles will illuminate blades for up to 5 hours.

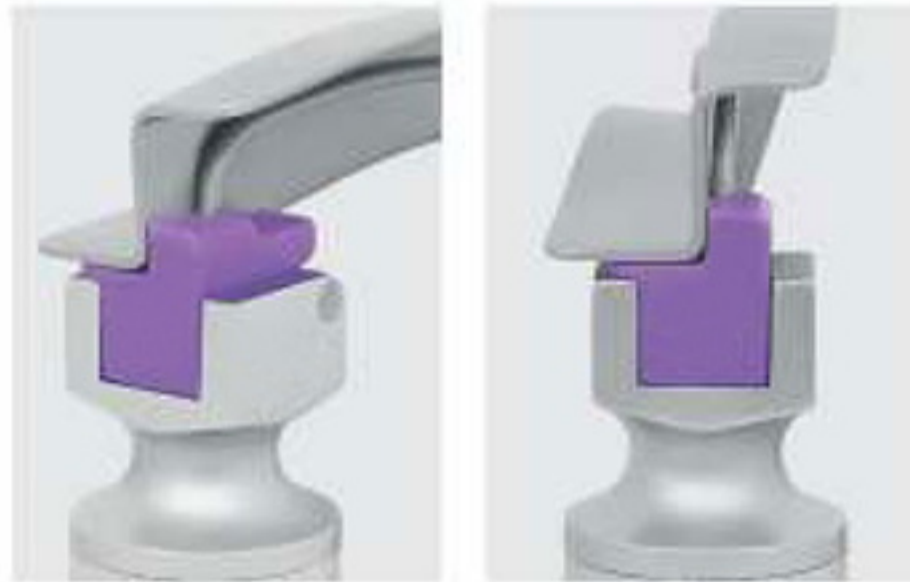

Disposable
Conventional Handle

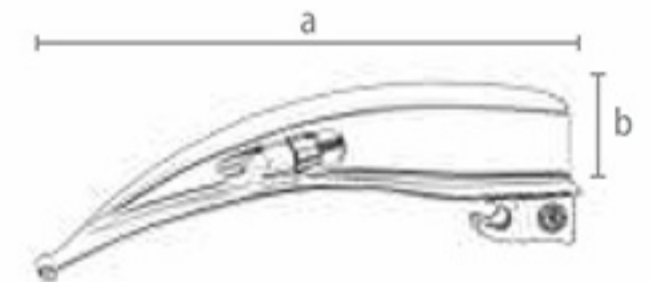

| Macintosh Disposable Conventional Laryngoscope Blade. | | | |
|---|------------------------|--------|--------|
| Size | Blade Reference no. | Length | |
| | | a (mm) | b (mm) |
| 1 | SI-300-01 | 102 | 18 |
| 2 | SI-300-02 | 115 | 18 |
| 3 | SI-300-03 | 137 | 21 |
| 4 | SI-300-04 | 157 | 21 |

| Macintosh Disposable Conventional Laryngoscope Sets. | |
|--|-------------------------------------|
| Reference no. | Description |
| SI-300-10 | 2 Blades + 1 Handle in Plastic Box. |
| SI-300-20 | 3 Blades + 1 Handle in Plastic Box. |
| SI-300-30 | 4 Blades + 1 Handle in Plastic Box. |

MILLER, DISPOSABLE CONVENTIONAL LARYNGOSCOPE



Dual Lighted Conventional Laryngoscope Blade UV/WHITE LED

Plastic Heel

White and UV LED lighting combination produces optimized high definition viewing area,

- Blade made of 304 type non-magnet stainless steel with plastic heel.
- Smooth shape avoids sharp edges and cavities.
- Compatible with all standard conventional handles.
- Conventional disposable handle made of silver, with LED light.
- According to ISO 7376 standard.

Power Source

- Watch-size lithium batteries are pre-installed for quick single use, and are easily removed for separate disposal. These Fiber Optic disposable handles will illuminate blades for up to 5 hours.

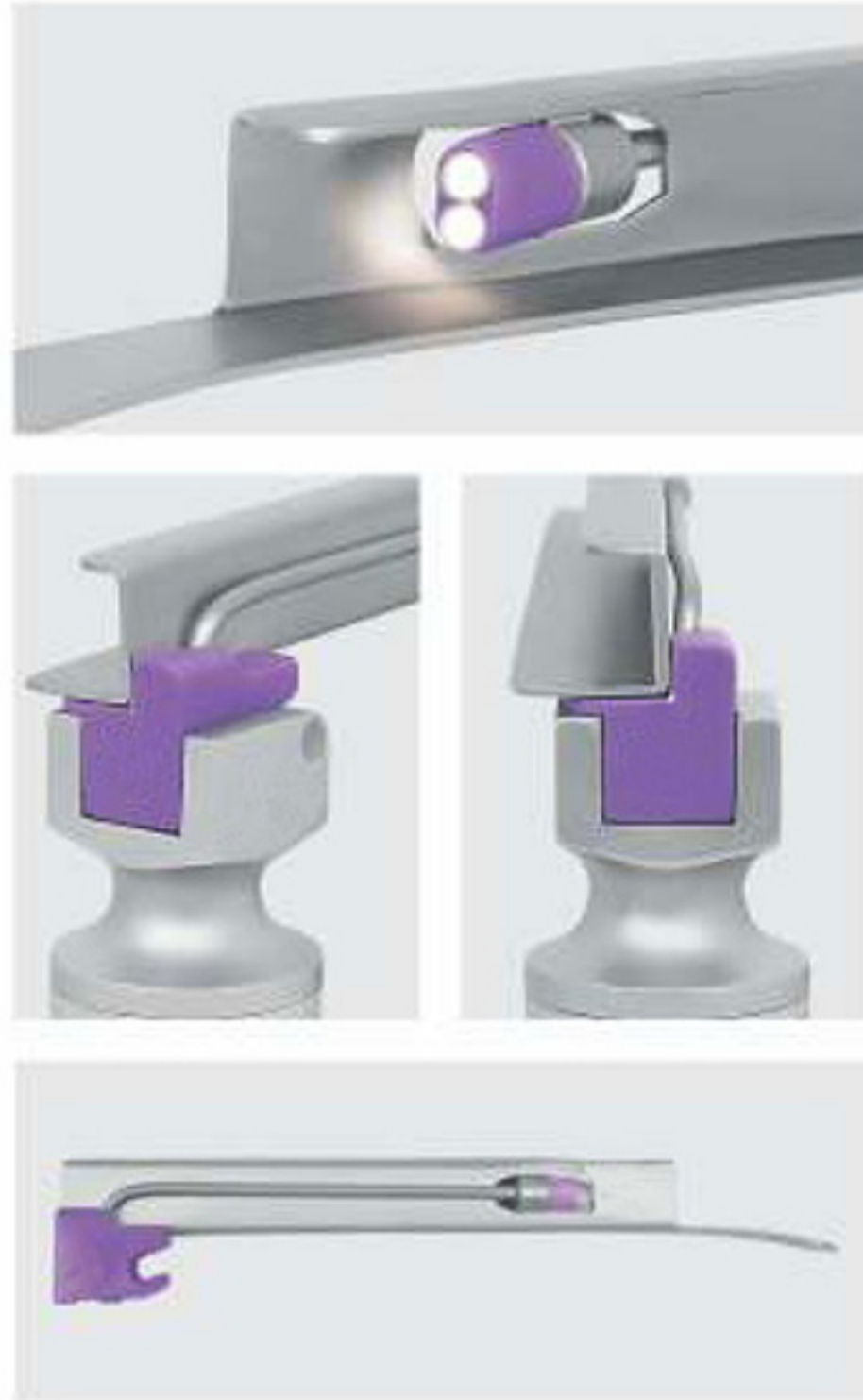

Disposable
Conventional Handle

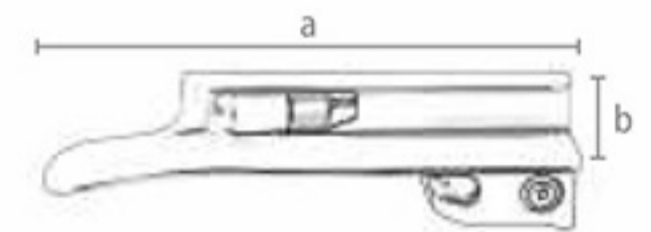

Miller Disposable Conventional Laryngoscope Blade.

| Size | Blade Reference no. | Length | |
|------|------------------------|--------|--------|
| | | a (mm) | b (mm) |
| 00 | SI-305-00 | 66 | 11 |
| 0 | SI-305-0 | 76 | 11 |
| 1 | SI-305-01 | 104 | 11 |
| 2 | SI-305-02 | 155 | 14 |
| 3 | SI-305-03 | 195 | 14 |
| 4 | SI-305-04 | 205 | 14 |

Miller Disposable Conventional Laryngoscope Sets.

| Reference no. | Description |
|---------------|-------------------------------------|
| SI-305-10 | 3 Blades + 1 Handle in Plastic Box. |
| SI-305-20 | 4 Blades + 1 Handle in Plastic Box. |
| SI-305-30 | 5 Blades + 1 Handle in Plastic Box. |

MACHINTOSH, DISPOSABLE FIBER OPTIC LARYNGOSCOPE



Fiber Optic Handle



Fiber Optic (F.O.) Laryngoscope Blade BLACK JACKET LIGHT

Stainless Steel Heel

Disposable Macintosh Laryngoscope blade with 4 mm plastic end LIT Fiber Optic, it is processed from plastic Fiber Optic. We coat a plastic PVC jacket to protect inner fiber, working well keep it longer life and get more brightness from Illuminator.

- :- Blade made of 303/304 type non-magnet stainless steel.
- :- Smooth shape avoids sharp edges and cavities.
- :- Fiber Optic handle with LED light.
- :- Compatible with all standard Fiber Optic handles.
- :- Smooth knurled Handle provides grip without risk of tearing gloves.
- :- According to ISO 7376 standard.

Power Source

- :- All our Fiber Optic handles are powered by
- Standard battery handle: 2" C" size
- Pediatric battery handle: 2" AA" size
- Stubby battery handle: 2" AA" size

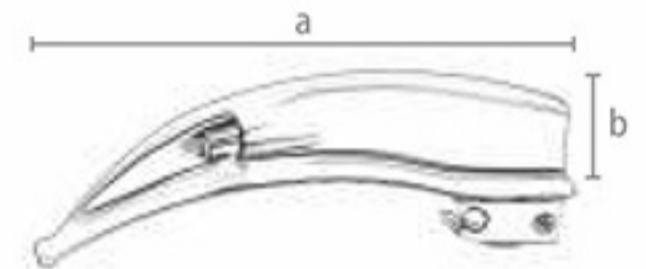

| Macintosh Disposable Fiber Optic (F.O.) Laryngoscope Blade. | | | |
|---|---------------|--------|--------|
| Size | Blade | Length | |
| | Reference no. | a (mm) | b (mm) |
| 1 | SI-310-01 | 102 | 18 |
| 2 | SI-310-02 | 115 | 18 |
| 3 | SI-310-03 | 137 | 21 |
| 4 | SI-310-04 | 157 | 21 |

| Macintosh Disposable Fiber Optic (F.O.) Laryngoscope Sets. | |
|--|-------------------------------------|
| Reference no. | Description |
| SI-310-10 | 2 Blades + 1 Handle in Plastic Box. |
| SI-310-20 | 3 Blades + 1 Handle in Plastic Box. |
| SI-310-30 | 4 Blades + 1 Handle in Plastic Box. |

MACHINTOSH, DISPOSABLE FIBER OPTIC (F.O) LARYNGOSCOPE



Fiber Optic (F.O.) Laryngoscope Blade BLACK JACKET LIGHT

Silver Heel

Disposable Macintosh Laryngoscope blade with 4 mm plastic end lit Fiber Optic, it is processed from plastic Fiber Optic. We coat a plastic PVC jacket to protect inner fiber, working well keep it longer life and get more brightness from Illuminator.

- Blade made of 304 type non-magnet stainless steel with silver heel.
- Smooth shape avoids sharp edges and cavities.
- Disposable fiber Optic handle made of silver and powder coated with LED light.
- Compatible with all standard Fiber Optic handles.
- According to ISO 7376 standard.

Power Source

- Watch-size lithium batteries are pre-installed for quick single use, and are easily removed for separate disposal. These Fiber Optic disposable handles will illuminate blades for up to 5 hours.

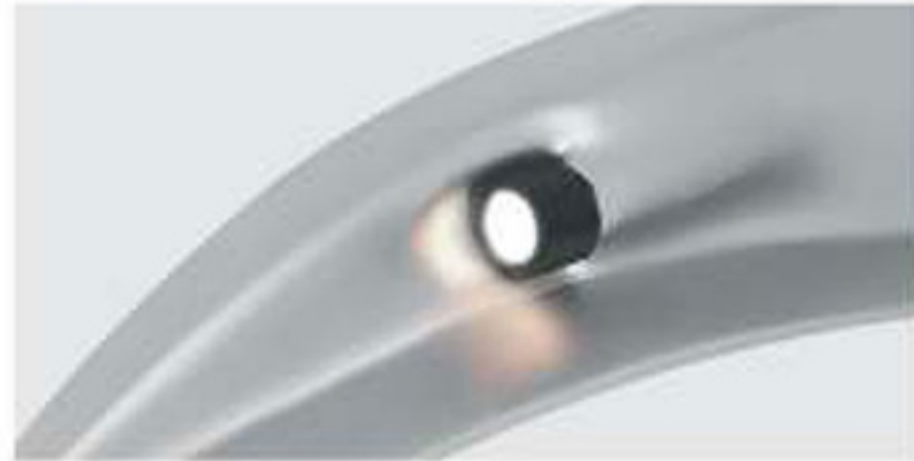

Disposable
Fiber Optic Handle

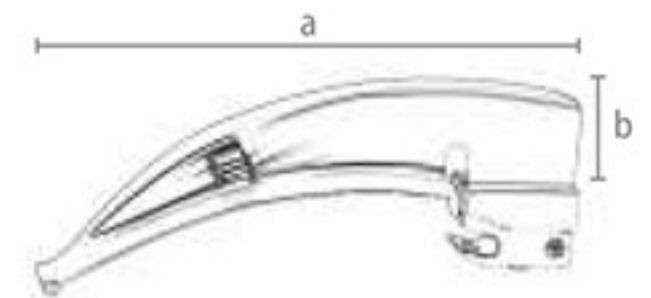

Macintosh Disposable Fiber Optic (F.O.) Laryngoscope Blade.

| Size | Blade Reference no. | Length | |
|------|------------------------|--------|--------|
| | | a (mm) | b (mm) |
| 1 | SI-315-01 | 102 | 18 |
| 2 | SI-315-02 | 115 | 18 |
| 3 | SI-315-03 | 137 | 21 |
| 4 | SI-315-04 | 157 | 21 |

Macintosh Disposable Fiber Optic (F.O.) Laryngoscope Sets.

| Reference no. | Description |
|---------------|-------------------------------------|
| SI-315-10 | 2 Blades + 1 Handle in Plastic Box. |
| SI-315-20 | 3 Blades + 1 Handle in Plastic Box. |
| SI-315-30 | 4 Blades + 1 Handle in Plastic Box. |

MACHINTOSH, DISPOSABLE FIBER OPTIC (F.O) LARYNGOSCOPE



Fiber Optic (F.O.) Laryngoscope Blade BLACK JACKET LIGHT

PlasticHeel

Disposable Macintosh Laryngoscope blade with 4 mm plastic end lit Fiber Optic, it is processed from plastic Fiber Optic. We coat a plastic PVC jacket to protect inner fiber, working well keep it longer life and get more brightness black jacketed from Illuminator.

- Blade made of 304 type non-magnet stainless steel with plastic heel.
- Smooth shape avoids sharp edges and cavities.
- Compatible with all standard Fiber Optic handles.
- Disposable fiber Optic handle, made of silver, with LED light.
- According to ISO 7376 standard.

Power Source

- Watch-size lithium batteries are pre-installed for quick single use, and are easily removed for separate disposal. These Fiber Optic disposable handles will illuminate blades for up to 5 hours.

Available Colors:



Disposable
Fiber Optic Handle

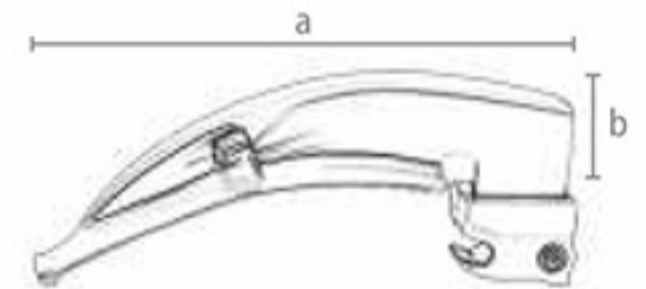

Macintosh Disposable Fiber Optic (F.O.) Laryngoscope Blade.

| Size | Blade Reference no. | Length | |
|------|------------------------|--------|--------|
| | | a (mm) | b (mm) |
| 1 | SI-320-01 | 102 | 18 |
| 2 | SI-320-02 | 115 | 18 |
| 3 | SI-320-03 | 137 | 21 |
| 4 | SI-320-04 | 157 | 21 |

Macintosh Disposable Fiber Optic (F.O.) Laryngoscope Sets.

| Reference no. | Description |
|---------------|-------------------------------------|
| SI-320-10 | 2 Blades + 1 Handle in Plastic Box. |
| SI-320-20 | 3 Blades + 1 Handle in Plastic Box. |
| SI-320-30 | 4 Blades + 1 Handle in Plastic Box. |

MILLER, DISPOSABLE FIBER OPTIC (F.O) LARYNGOSCOPE



Fiber Optic (F.O.) Laryngoscope Blade BLACK JACKET LIGHT

Plastic Heel

Disposable Miller Laryngoscope blade with 4 mm plastic end lit Fiber Optic, it is processed from plastic Fiber Optic. We coat a plastic PVC jacket to protect inner fiber, working well keep it longer life and get more brightness black jacketed from Illuminator.

- Blade made of 304 type non-magnet stainless steel with plastic heel.
- Smooth shape avoids sharp edges and cavities.
- Compatible with all standard Fiber Optic handles.
- Disposable fiber Optic handle, made of silver, with LED light.
- According to ISO 7376 standard.

Power Source

- Watch-size lithium batteries are pre-installed for quick single use, and are easily removed for separate disposal. These Fiber Optic disposable handles will illuminate blades for up to 5 hours.

Available Colors:



Disposable
Fiber Optic Handle

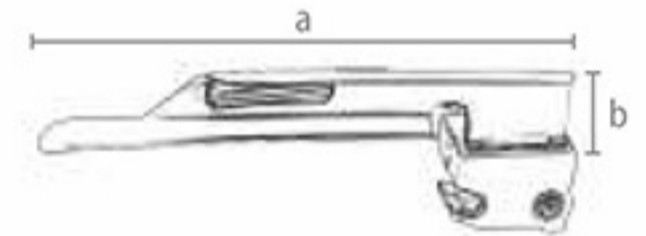

Miller Disposable Fiber Optic (F.O.) Laryngoscope Blade.

| Size | Blade Reference no. | Length | |
|------|---------------------|--------|--------|
| | | a (mm) | b (mm) |
| 00 | SI-325-00 | 66 | 11 |
| 0 | SI-325-0 | 76 | 11 |
| 1 | SI-325-01 | 104 | 11 |
| 2 | SI-325-02 | 155 | 14 |
| 3 | SI-325-03 | 195 | 14 |
| 4 | SI-325-04 | 205 | 14 |

Miller Disposable Fiber Optic (F.O.) Laryngoscope Sets.

| Reference no. | Description |
|---------------|-------------------------------------|
| SI-325-10 | 3 Blades + 1 Handle in Plastic Box. |
| SI-325-20 | 4 Blades + 1 Handle in Plastic Box. |
| SI-325-30 | 5 Blades + 1 Handle in Plastic Box. |

MACINTOSH, DISPOSABLE, FIBER OPTIC (F.O) LARYNGOSCOPE



Disposable Fiber Optic (F.O.) Laryngoscope Blade F.O.ACRYLIC ROD Silver Heel

Macintosh Single-Use Fiber Optic Blade with 5mm diameter acrylic rod for improved light transmission.

- Blade made of 304 type non-magnet stainless steel with silver heel.
- Smooth shape avoids sharp edges and cavities.
- Fiber Optic handle, made of silver, with LED light.
- Compatible with all standard Fiber Optic handles.
- According to ISO 7376 standard.

Power Source

- Watch-size lithium batteries are pre-installed for quick single use, and are easily removed for separate disposal. These Fiber Optic disposable handles will illuminate blades for up to 5 hours.

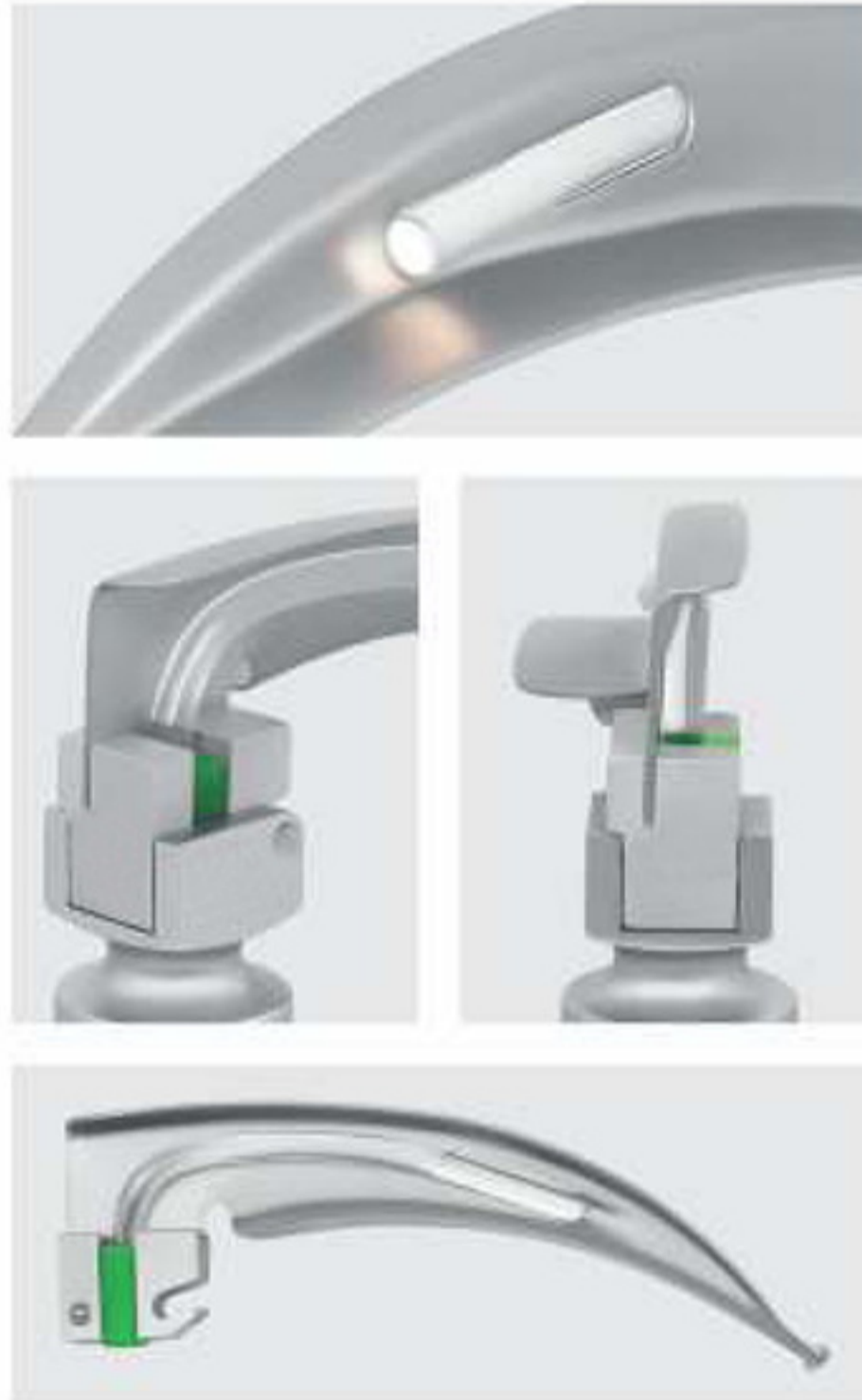

Disposable
Fiber Optic Handle

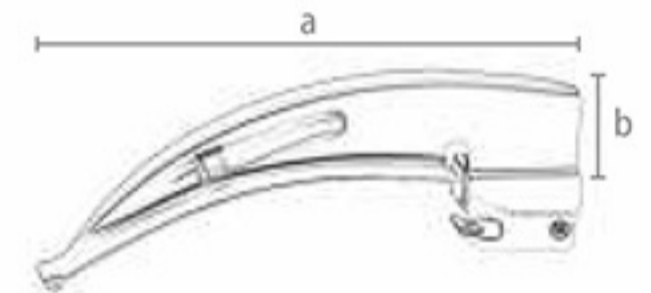

| Macintosh Disposable Fiber Optic (F.O.) Laryngoscope Blade. | | | |
|---|------------------------|--------|--------|
| Size | Blade Reference no. | Length | |
| | | a (mm) | b (mm) |
| 1 | SI-330-01 | 102 | 18 |
| 2 | SI-300-02 | 115 | 18 |
| 3 | SI-300-03 | 137 | 21 |
| 4 | SI-300-04 | 157 | 21 |

| Macintosh Disposable Fiber Optic (F.O.) Laryngoscope Sets. | |
|--|-------------------------------------|
| Reference no. | Description |
| SI-300-10 | 2 Blades + 1 Handle in Plastic Box. |
| SI-300-20 | 3 Blades + 1 Handle in Plastic Box. |
| SI-300-30 | 4 Blades + 1 Handle in Plastic Box. |

MACINTOSH, DISPOSABLE, FIBER OPTIC (F.O) LARYNGOSCOPE



Disposable Fiber Optic (F.O.) Laryngoscope Blade F.O.ACRYLIC ROD

Silver Heel

Macintosh Single-Use Fiber Optic Blade with 5mm diameter acrylic rod for light transmission.

- Blade made of 304 type non-magnet stainless steel with plastic heel.
- Smooth shape avoids sharp edges and cavities.
- Fiber Optic handle, made of silver, with LED light.
- Compatible with all standard Fiber Optic handles.
- According to ISO 7376 standard.

Power Source

- Watch-size lithium batteries are pre-installed for quick single use, and are easily removed for separate disposal. These Fiber Optic disposable handles will illuminate blades for up to 5 hours.



Disposable
Fiber Optic Handle

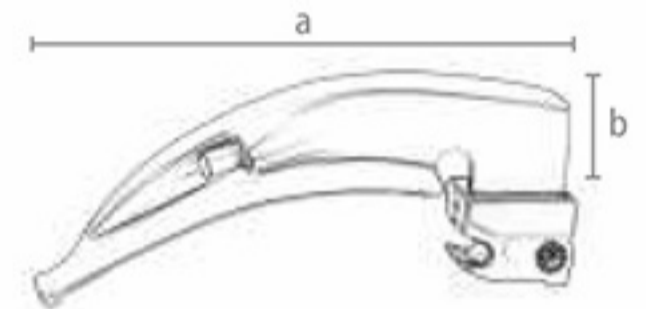

Macintosh Disposable Fiber Optic (F.O.) Laryngoscope Blade.

| Size | Blade Reference no. | Length | |
|------|------------------------|--------|--------|
| | | a (mm) | b (mm) |
| 1 | SI-335-01 | 102 | 18 |
| 2 | SI-335-02 | 115 | 18 |
| 3 | SI-335-03 | 137 | 21 |
| 4 | SI-335-04 | 157 | 21 |

Macintosh Disposable Fiber Optic (F.O.) Laryngoscope Sets.

| Reference no. | Description |
|---------------|-------------------------------------|
| SI-335-10 | 2 Blades + 1 Handle in Plastic Box. |
| SI-335-20 | 3 Blades + 1 Handle in Plastic Box. |
| SI-335-30 | 4 Blades + 1 Handle in Plastic Box. |

MILLER, DISPOSABLE, FIBER OPTIC (F.O.) LARYNGOSCOPE



Disposable Fiber Optic (F.O.) Laryngoscope Blade F.O.ACRYLIC ROD

Silver Heel

Miller Single-Use Fiber Optic Blade with 5mm diameter acrylic rod for improved light transmission.

- Blade made of 304 type non-magnet stainless steel with plastic heel.
- Smooth shape avoids sharp edges and cavities.
- Fiber Optic handle, made of silver, with LED light.
- Compatible with all standard Fiber Optic handles.
- According to ISO 7376 standard.

Power Source

- Watch-size lithium batteries are pre-installed for quick single use, and are easily removed for separate disposal. These Fiber Optic disposable handles will illuminate blades for up to 5 hours.



Disposable
Fiber Optic Handle

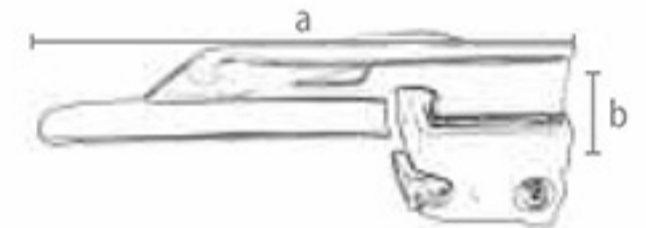

Miller Disposable Fiber Optic (F.O.) Laryngoscope Blade.

| Size | Blade Reference no. | Length | |
|------|------------------------|--------|--------|
| | | a (mm) | b (mm) |
| 00 | SI-340-00 | 66 | 11 |
| 0 | SI-340-0 | 76 | 11 |
| 1 | SI-340-01 | 104 | 11 |
| 2 | SI-340-02 | 155 | 14 |
| 3 | SI-340-03 | 195 | 14 |
| 4 | SI-340-04 | 205 | 14 |

Miller Disposable Fiber Optic (F.O.) Laryngoscope Sets.

| Reference no. | Description |
|---------------|-------------------------------------|
| SI-340-10 | 3 Blades + 1 Handle in Plastic Box. |
| SI-340-20 | 4 Blades + 1 Handle in Plastic Box. |
| SI-340-30 | 5 Blades + 1 Handle in Plastic Box. |

MACINTOSH, DISPOSABLE, CONVENTIONAL LARYNGOSCOPE



Conventional Laryngoscope Blade LED LIGHT

Plastic Heel

Macintosh Single-Use Conventional Blade with LED light plastic heel and disposable handle.

- Blade made of 304 type non-magnet stainless steel with plastic heel.
- Smooth shape avoids sharp edges and cavities.
- Compatible with all standard Conventional handles.
- Conventional handle, made of silver with powder coating.
- According to ISO 7376 standard.

Power Source

- Watch-size lithium batteries are pre-installed for quick single use, and are easily removed for separate disposal. These Fiber Optic disposable handles will illuminate blades for up to 5 hours.

Available Colors:

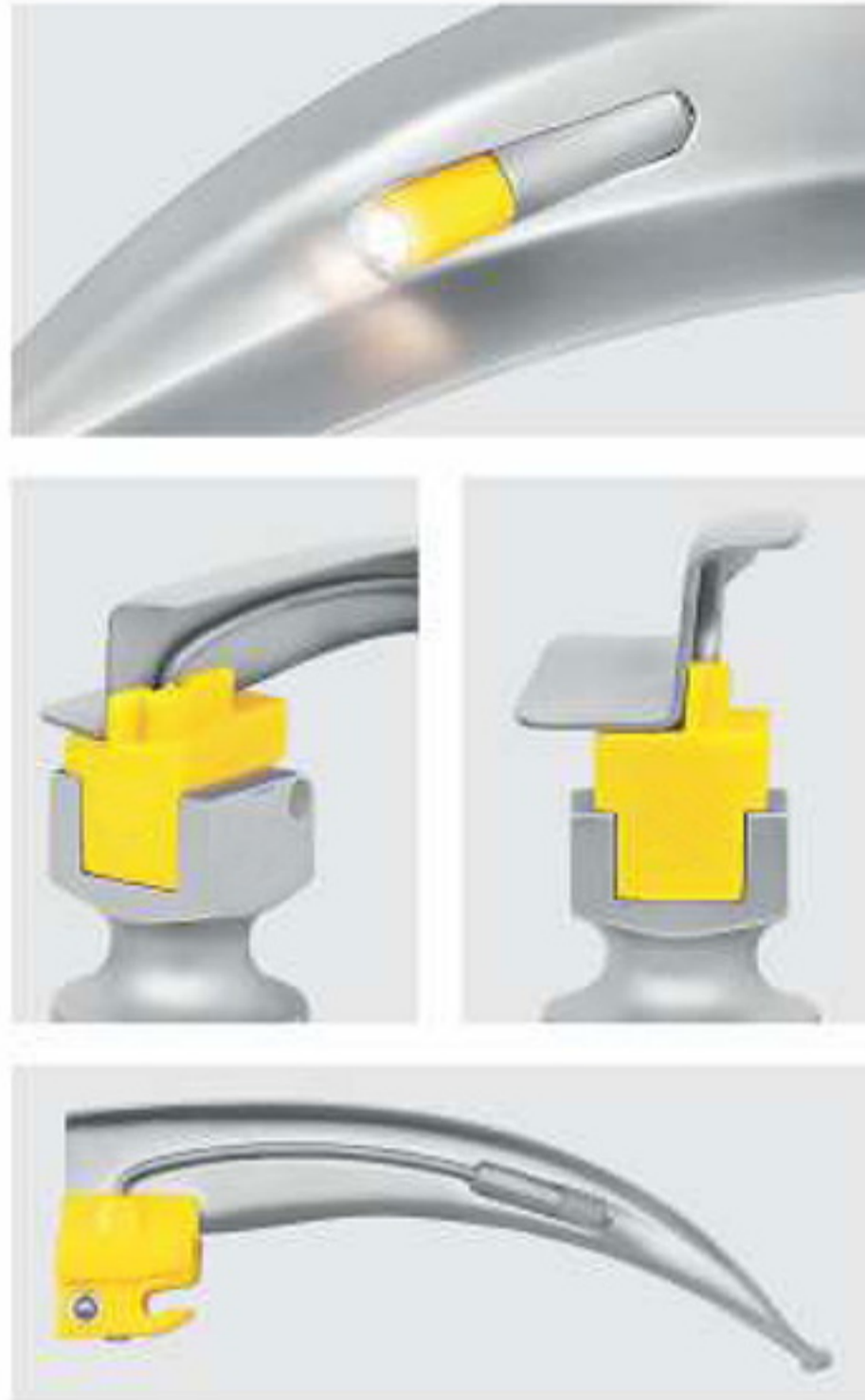

Disposable
Conventional Handle

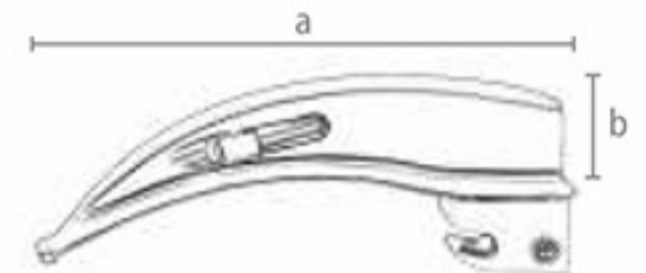

| Disposable Conventional Laryngoscope Blade | | | |
|--|------------------------|--------|--------|
| Size | Blade Reference no. | Length | |
| | | a (mm) | b (mm) |
| 1 | SI-345-01 | 102 | 18 |
| 2 | SI-345-02 | 115 | 18 |
| 3 | SI-345-03 | 137 | 21 |
| 4 | SI-345-04 | 157 | 21 |

| Disposable Conventional Laryngoscope Sets. | |
|--|-------------------------------------|
| Reference no. | Description |
| SI-345-10 | 2 Blades + 1 Handle in Plastic Box. |
| SI-345-20 | 3 Blades + 1 Handle in Plastic Box. |
| SI-345-30 | 4 Blades + 1 Handle in Plastic Box. |

FIBER OPTIC (F.O) LARYNGOSCOPE HANDLES



Fiber Optic (F.O.) Laryngoscope Handles

- Complies with ISO 7376 Green standard.
- Premium Handles & LED lamp have a lifetime warranty.
- Low power use prolongs battery life.
- Cool, white illumination improves view of larynx.
- Knurled Finish for secure & positive grip.
- Batteries not included.

| Fiber Optic Laryngoscope Handles | | |
|----------------------------------|-----------------|-------------|
| Reference no. | Size | Batteries |
| SI-400-10 | Large | 2 x " D " |
| SI-400-20 | Medium/Standard | 2 x " C " |
| SI-400-30 | Small/Pen light | 2 x " AA " |
| SI-400-40 | Stubby | 2 x " AA " |
| SI-400-50 | Micro | Lithium 123 |

CONVENTIONAL LARYNGOSCOPE HANDLES



Conventional Laryngoscope Handles

- Complies with ISO 7376 Green standard.
- Premium Handles have a lifetime warranty.
- Low power use prolongs battery life.
- Cool, white illumination improves view of larynx.
- Knurled Finish for secure & positive grip.
- Batteries not included.

| Conventional Laryngoscope Handles | | |
|-----------------------------------|-----------------|-------------|
| Reference no. | Size | Batteries |
| SI-410-10 | Large | 2 x " D " |
| SI-410-20 | Medium/Standard | 2 x " C " |
| SI-410-30 | Small/Pen light | 2 x " AA " |
| SI-410-40 | Stubby | 2 x " AA " |
| SI-410-50 | Micro | Lithium 123 |

ENT PRODUCT SECTION

Diagnostic Sets
Instruments
Accessories

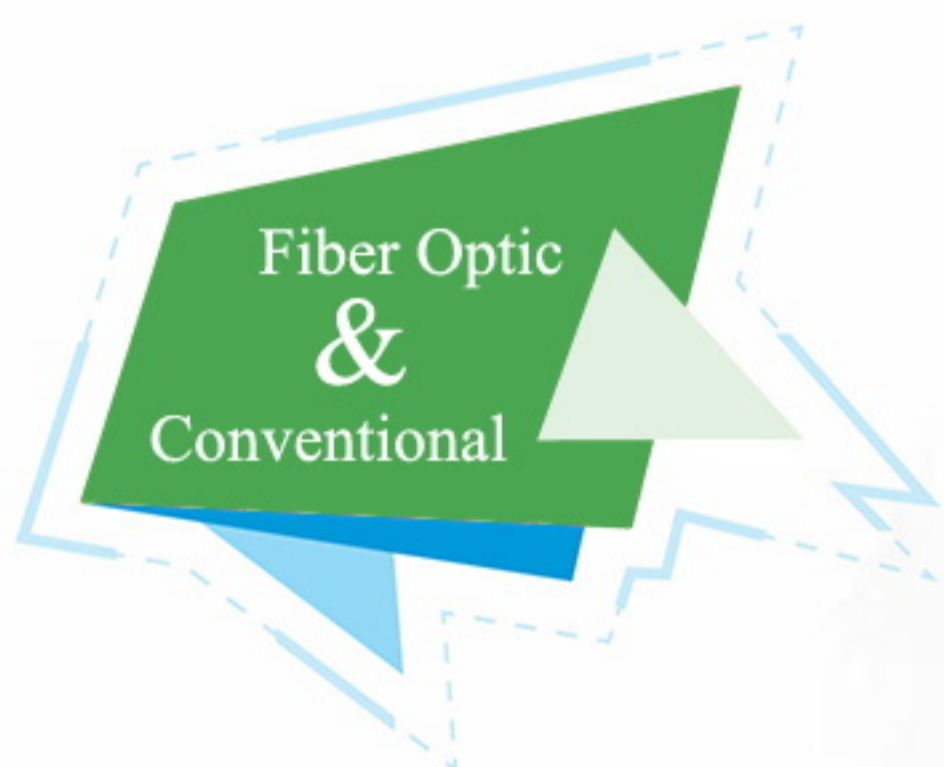

MINI OTOSCOPES



500-10

Fiber Optic (Pocket Style)

2.5v LED

High Quality pocket sized Mini Fiber Optic Otoscope with extra bright light with 3x magnification lens. Distal Fiber Optic illumination 4mm bundle with Enhanced LED technology.

Attachment clip with integrated on/off switch.

Power Supply: 2x AA Batteries (not included in set).

Packing: In Gray or Black pouch with 10 disposable Specula Dia 2.5mm & 4.0 mm

Available Colours: 



500-20

Fiber Optical (Pocket Style)

2.5v LED

Modern pocket otoscope compact design. Handy and powerful. Distal Fiber-Optic (F.O.) illumination 4mm bundle with Enhanced LED Technology.

Attachment clip with integrated on/off switch.

Power Supply: 2x AA Batteries (not included in set).

Packing: In Gray or Black pouch with 10 disposable Specula Dia 2.5mm & 4.0 mm

Available Colours: 



METAL OTOSCOPIES



500-30

Fiber Optic (Metal Otoscope)

2.5v LED

Equipped with an easy to use Bayonet connecting system with high quality professional metal head. Chrome plated knurled battery handle makes surface, a secure grip in the hand. Extra bright light of 2.5v LED bulb illumination provided through Fiber Optic system.

3 X High Quality magnifying Lens.

Power Supply: 2x AA Batteries (not included in set).

Packing: In Gray or Black pouch / plastic box with 10 disposable Specula Dia 2.5mm & 4.0 mm



500-40

Conventional (Plastic Head Otoscope)

2.5v LED

Equipped with an easy to use Bayonet connecting system with high quality plastic head. Chrome plated knurled battery handle makes surface, a secure grip in the hand. Extra bright light of 2.5v LED bulb illumination.

3 X High Quality magnifying Lens.

Power Supply: 2x AA Batteries (not included in set).

Packing: In Gray or Black pouch / plastic box with 10 disposable Specula Dia 2.5mm & 4.0 mm



METAL OTOSCOPIES



500-50

Conventional (Parker Metal Otoscope)

High quality professional Parker Otoscope with extra bright light. 2.5v LED illumination with 3 X magnifying lens.

Available in Satin and Polish Finish.

Power Supply: 2 x AA Batteries (not included in set).

Packing: In Gray or Black pouch / plastic box with 10 disposable Specula Dia 2.5mm & 4.0 mm

2.5v LED



500-60

Conventional (Metal Otoscope)

Standard metal otoscope with bayonet connecting head fitting. Ideal for pneumatic tympanic membrane test and every day ENT use. 2.5 v LED white Light.

Available in Satin & polish Finish.

Power Supply: 2 x AA Batteries (not included in set).

Packing: In Gray or Black pouch / plastic box with 10 disposable Specula Dia 2.5mm & 4.0 mm

2.5v LED



STANDARD VETERINARY OTOSCOPIES



500-70

Conventional
(Veterinary Metal Otoscope)



Open system with rotatable lens and optional speculum for convenient procedures. 2.5v LED illumination. Knurled handle with a beautiful satin finish.

Power Supply: 2 x AA Batteries (not included in set).

Packing: In Gray or Black pouch / plastic box with 3 Vet reusable Specula Dia 4.0, 5.0, 7.0 mm



500-80

Conventional
(Veterinary Metal Otoscope)



Bayonet locking otoscope head with 3x magnifying lens. 2.5V Led Illumination. Knurled handle with a beautiful satin finish.

Power Supply: 2 x AA Batteries (not included in set).

Packing: In Gray or Black pouch / plastic box with 3 Vet reusable Specula Dia 4.0, 5.0, 7.0 mm



MINI OPHTHALMOSCOPES



600-10

(Pocket Ophthalmoscope)

The Pocket size Ophthalmoscope is a lightweight, compact diagnostic instrument that delivers high performance in a slightly smaller package. Quality optics in mini-format is ideal for rounds and house calls. Attachment clip with integrated on/off switch. High-quality plastic handle with shockproof, sturdy, non-slip features. Enhanced LED Technology for perfect illumination and a brilliant image. 4 different apertures. Comprehensive lens range from + 20 D to -20 D.

Power Supply: 2 x AA Batteries (not included in set).
Packing: Hard plastic case packing.

The ophthalmoscope is a tool used in medical to examine the interior of the eye. Studying the inner parts of the eye, such as the optic disk, retinal blood vessels, retina, choroid and macula, can help diagnose diseases of the eye.

600-20

(Ophthalmoscope)

2.5v LED lamp light for true tissue color and consistent long lasting illumination 16 color coded lenses -25 to +25 for excellent resolution (Red for - Black for +) 4 different apertures (small, large, blue, half moon focus) Rubber eye brow rest to prevent scratching of eye-glasses illumination lens dial for clear identification of adopter setting.

Power Supply: 2 x AA Batteries (not included in set).
Packing: Hard plastic case packing.



MINI & STANDARD OPHTHALMOSCOPE



600-30

(Ophthalmoscope)

Parker mini Ophthalmoscope with 2.5v LED bulb light for true tissue color and consistent long lasting illumination 24 color coded lenses - 25 to + 40 for excellent resolution (Red for - Green for +) Rubber eye brow rest to prevent scratching of eye-glasses illumination lens dial for clear identification fo adopter setting.

Power Supply: 2 x AA Batteries (not included in set).

Packing: Hard plastic case packing.



600-40

(Ophthalmoscope)

Parker mini Ophthalmoscope with 2.5v LED bulb light for true tissue color and consistent long lasting illumination 24 color coded lenses - 25 to + 40 for excellent resolution (Red for - Green for +) Rubber eye brow rest to prevent scratching of eye-glasses illumination lens dial for clear identification fo adopter setting.

Power Supply: 2 x C Batteries (not included in set).

Packing: Hard plastic case packing.

DERMATOSCOPES



700-10

(Dermatoscope)

Modern pocket Dermatoscope in a compact design with high-quality optics. 10X magnification large, high-resolution image. Choice of two skin-friendly and sterilizable contact plates: with scale from 0 - 10mm for exact measurement of pigmented skin lesions, without scale. Simple lamp change on the underside of the instruments head. Enhanced LED Technology for more light. Attachment clip with integrated On/Off switch. High-quality 2 color handle.

Power Supply: 2 x AA Batteries (not included in set).

Packing: Hard plastic case packing.



700-20

(Dermatoscope)

Bayonet locking system for easy engagement and disengagement from the handle. 2.5v LED illumination of the examination field. High resolution achromatic lenses system with 10x magnification. Adjustable focusing Eyepiece for a large correction range. Lens without scale. Soft eyepiece protection.

Available in Polish and Sand finish.

Power Supply: 2 x C Batteries (not included in set).

Packing: Hard plastic case packing.

TUNING FORKS



SI-900-18
Alloy
256

SI-900-19
Alloy
512

SI-900-20
Alloy
1024

SI-900-21
Alloy
2048

SI-900-22
Alloy
4096

SI-900-23
Hartman
256

SI-900-24
Hartman
512

SI-900-25
Hartman
1024

SI-900-26
Hartman
2048

SI-900-27
Hartman
4096



SI-900-28
Lucae
256

SI-900-29
Lucae
512



SI-900-30
Alloy with
Weights
128



SI-900-31
Alloy with
Weights
256



SI-900-32
Taylor
128



SI-900-33
Konig
128



SI-900-34
Rydel Seiffert

ACCESSORIES



900-35
Bulb for mini
Ophthalmoscope,
2.5V (LED)



900-36
Bulb for
Ophthalmoscope,
2.5V (LED)



900-37
Bulb for
Dermatoscope,
2.5V (LED)



Small Large
900-38
Bulb for
Conventional
Laryngoscope,
2.5V (LED)



900-39
Bulb for
Otoscope,
2.5V (LED)
Thread 8-32 in 5mm



900-40
Bulb for
Fibber Optic
Laryngoscope
2.5V (LED)



900-41
Contact Plate
with Scale



900-42
Contact Plate Plain



900-43
Reusable Speculas
Ø 4mm, Ø 5mm & Ø 6mm



900-44
Mini Disposable Speculas
Ø 2.5mm, Ø 4mm



900-45
Reusable Speculas
Ø 2.5mm, Ø 3.5mm & Ø 4.5mm



900-46
Standard Disposable Speculas
Ø 2.5mm, Ø mm



900-47
Metal converter
for mini disposable
speculas



900-48
Plastic ABS converter
for mini disposable
speculas



900-51
Insufflation bulb
for pneumatic testing



900-55
Mini Tongue
Blade Holder



900-56
Blade



Gray Black
900-57
Mini Clip Lamp
(Black, Gray)



900-49
Curved Illuminator Conventional



900-50
Curved Illuminator FiberOptic



900-52
Screw Nose Speculum



900-53
Laryngeal Plain
Mirror # 4



900-54
Laryngeal Plain
Mirror # 3



900-58
Adopter for Tongue
Depressor



900-59
Metal Tongue Depressor



Aulakh Jattan P.O. Ugoki
Sialkot Pakistan
Phone: +92 328 6284345
Email: info@fm-surgical.com
Website: www.fm-surgical.com