

SURGICAL INSTRUMENTS



FAIZAN & MUSA SURGICAL INSTRUMENTS



OEM

ORIGINAL | EQUIPMENTS | MANUFACTURER

ODM

ORIGINAL | DESIGN | MANUFACTURER



Contents



**Scalpel
Handle**



Page 1 to 11



**Anaesthesia
Narkose**



Page 12 to 16



Diagnostic



Page 17 to 20



**Scissors
Scheren**



Page 21 to 45



Forceps



Page 54



**Artery
Forceps**



Page 55 to 70

Contents



**Cotton Swab
Forceps**



Page 71 to 76



**Probes
Applicators
Spatulas**



Page 77 to 79



Bone Surgery



Page 80 to 114



**Plaster
Instruments**



Page 115 to 117



Suture



Page 118 to 136



**Neuro
Surgery**

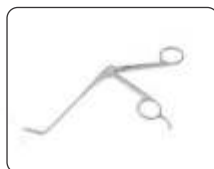

Page 137 to 148

Contents



**Cardiovas
cular Surgery**



Page 149 to 185



Tonsil



Page 186 to 196



Otology



Page 197 to 209



Rhinology



Page 210 to 223



**Oral
Instruments**



Page 224 to 237



**Stomach
Intestine**



Page 238 to 251

Contents

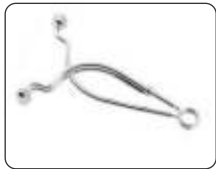

Kidney, Liver,
Urology

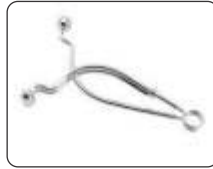

Page 252 to 262



Retractors



Page 263 to 300



Dermatology



Page 301 to 302



Tracheotomy



Page 303 to 305



Ophthalmology



Page 306 to 315



Gynecology



Page 316 to 328

Contents



Obstetrics



Page 329 to 336



Goitre



Page 337



Sterilization



Page 338



Asepsis



Page 340

- EN** **Scalpels**
- DE** **Skalpelle**
- ES** **Bisturías**
- FR** **Scalpels**
- IT** **Scalpelli**

Page 1 to 11



SCALPEL



Standard
 FM- 01-0101-03 # 3

FM- 01-0102-03 # 3

FM- 01-0103-03 # 4

FM- 01-0104-3L # 3L

FM- 01-0105-3L # 3L

FM- 01-0104-3XL # 3XL FM- 01-0105-3XL # 3XL
 angled

Scalpel Handles EN
 Skalpell-Griffe DE
 Mangos de bisturios ES
 Manches pour bistouris FR
 Manici per bisturi IT

01



SCALPEL

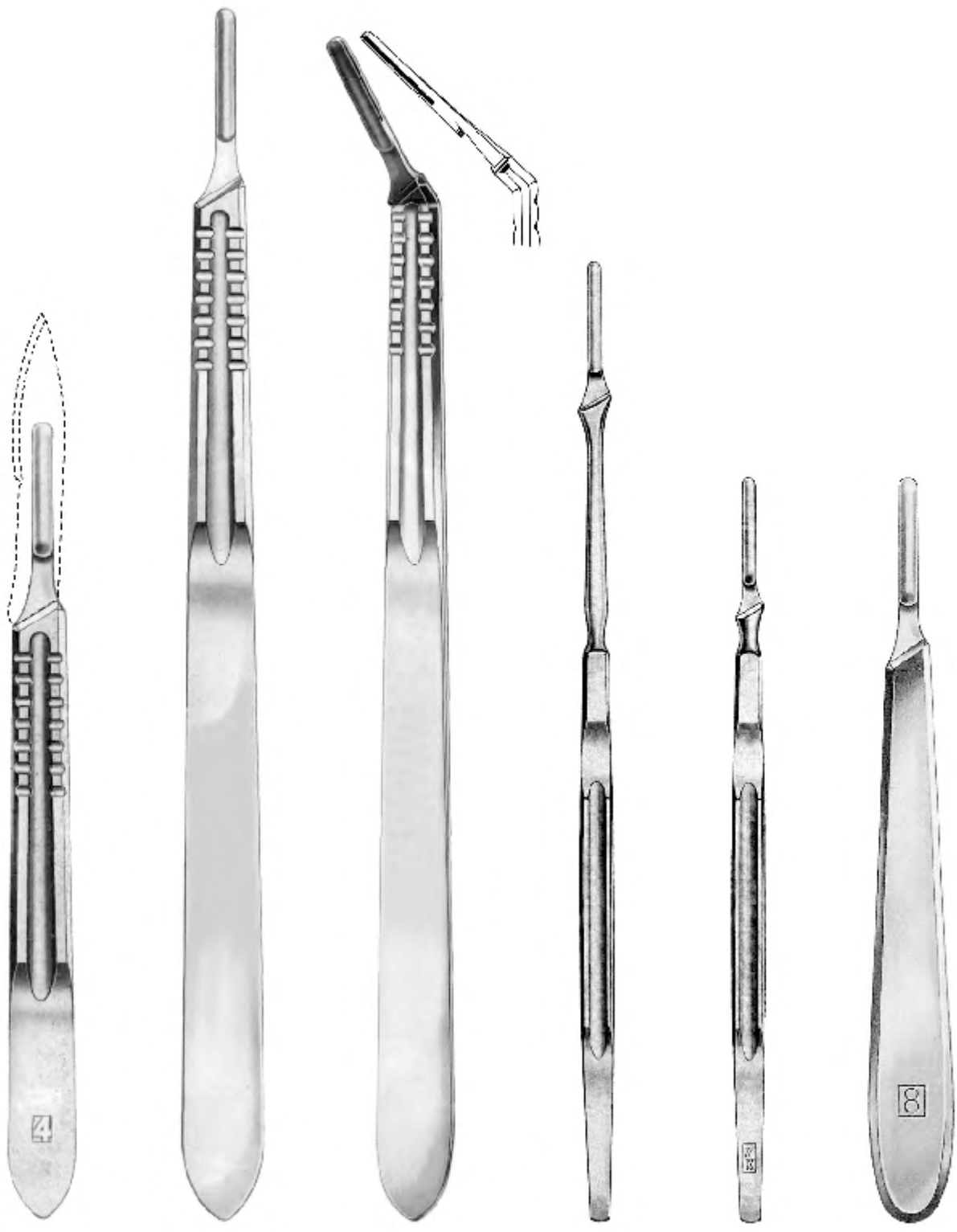

Standard

RAS-01-0106-04 # 4 FM- 01-0107-4L # 4L FM- 01-0108-4L # 4L FM- 01-0109-07 # 7 FM- 01-0110-07 # 7K FM- 01-0111-08
 FM- 01-0107-4XL # 4XL FM- 01-0108-4XL # 4XL
 angled

Collin

Fig. 8

EN Scalpel Handles

DE Skalpell-Griffe

ES Mangos de bisturios

FR Manches pour bistouris

IT Manici per bisturi



Collin
FM- 01-0112-09
Hollow, No. 9



Super
FM- 01-0113-10
Hollow, No. 10



FM- 01-0114-00
Hollow, round



FM- 01-0115-00
Plastics

Dissecting Knives EN

Anatomische Skalpelle DE

Bisturios para disección anatómica ES

Bistouris à dissection FR

Bisturi per dissezione IT

01



FAIZAN & MUSA
SPECIAL INSTRUMENTS

SCALPEL



17cm/6¾"



Fig. 1

FM- 01-0116-01



Fig. 2

FM- 01-0116-02



Fig. 3

FM- 01-0116-03



Fig. 4

FM- 01-0116-04



Fig. 5

FM- 01-0116-05



Fig. 6

FM- 01-0116-06



Fig. 7

FM- 01-0116-07



Fig. 8

FM- 01-0116-08



Fig. 9

FM- 01-0116-09



Fig. 10

FM- 01-0116-10

EN	Dissecting Knives
DE	Anatomische Skalpelle
ES	Bisturías para disección anatómica
FR	Bistouris à dissection
IT	Bisturi per dissezione

SCALPEL



Fig. 1 FM- 01-0117-01 Fig. 2 FM- 01-0117-02 Fig. 3 FM- 01-0117-03 Fig. 4 FM- 01-0117-04 Fig. 5 FM- 01-0117-05 Fig. 6 FM- 01-0117-06 Fig. 7 FM- 01-0117-07 Fig. 8 FM- 01-0117-08 Fig. 9 FM- 01-0117-09



Fig. 10 FM- 01-0117-10 Fig. 11 FM- 01-0117-11 Fig. 12 FM- 01-0117-12 Fig. 13 FM- 01-0117-13 Fig. 14 FM- 01-0117-14 Fig. 15 FM- 01-0117-15 Fig. 16 FM- 01-0117-16 Fig. 18 FM- 01-0117-18



Fig. 27 FM- 01-0117-27 Fig. 38 FM- 01-0117-38 Fig. 40 FM- 01-0117-40 Fig. 46 FM- 01-0117-46 Fig. 61 FM- 01-0117-61 Fig. 63 FM- 01-0117-63

17cm/6¾"

Dissecting Knives EN

Anatomische Skalpelle DE

Bisturios para disección anatómica ES

Bistouris à dissection FR

Bisturi per dissezione IT

01



FAIZAN & MUSA
SPECIAL INSTRUMENTS

SCALPEL



Dieffenbach
17cm/6 3/4"



Fig. 1
FM- 01-0118-01



Fig. 2
FM- 01-0118-02



Fig. 3
FM- 01-0118-03



Fig. 4
FM- 01-0118-04



Fig. 5
FM- 01-0118-05



Fig. 6
FM- 01-0118-06



Fig. 7
FM- 01-0118-07



Fig. 8
FM- 01-0118-08



Fig. 9
FM- 01-0118-09



Fig. 15
FM- 01-0118-15



Fig. 16
FM- 01-0118-16

EN	Dissecting Knives
DE	Anatomische Skalpelle
ES	Bisturios para disección anatómica
FR	Bistouris à dissection
IT	Bisturi per dissezione

SCALPEL



Fig. 1
Bergmann
FM- 01-0119-01
14.5cm/5¾"



Fig. 2
FM- 01-0119-02



Fig. 3
FM- 01-0119-03



Fig. 4
FM- 01-0119-04



Dieffenbach
13cm/5¼"



Fig. 1
FM- 01-0120-01



Fig. 2
FM- 01-0120-02



Fig. 3
FM- 01-0120-03



Fig. 4
FM- 01-0120-04



Fig. 5
FM- 01-0120-05



Fig. 6
FM- 01-0120-06



Fig. 7
FM- 01-0120-07



Fig. 8
FM- 01-0120-08



Fig. 9
FM- 01-0120-09



Fig. 10
FM- 01-0120-10



Fig. 11
FM- 01-0120-11



Fig. 12
FM- 01-0120-12

Dissecting Knives EN

Anatomische Skalpelle DE

Bisturios para disección anatómica ES

Bistouris à dissection FR

Bisturi per dissezione IT

01



FAIZAN & MUSA
SPECIAL INSTRUMENTS

SCALPEL



Flap knife

Phalangeal knife

Collin

Liston

Catlin

Langenbeck

Length of blades

cm in

9.5 3 3/4

11.0 4 1/2

12.0 4 3/4

13.0 5 FM- 01-0127-13

15.0 6

16.0 6 1/4 FM- 01-0127-16

17.0 6 3/4

19.0 7 1/2 FM- 01-0127-19 FM- 01-0128-17

20.0 8 FM- 01-0128-20

22.0 8 3/4 FM- 01-0127-22 FM- 01-0129-11

28.0 11 FM- 01-0127-28 FM- 01-0129-22

FM- 01-0131-09

FM- 01-0130-12

FM- 01-0129-11

FM- 01-0129-16

FM- 01-0129-19

FM- 01-0129-22

SCALPEL



Skull Breaker

FM- 01-0121-14
 14 cm/5½"



Rachiotome

FM- 01-0122-22
 22 cm/8¾"



23 mm

Osteotome

FM- 01-0123-13
 13 cm/5"



Brunetti

Brunetti

FM- 01-0124-28 FM- 01-0125-28

28.5 cm/11¼"

Muscle hooks



FM- 01-0126-06
 6.5 cm/2 ½"



FM- 01-0127-07
 7 cm/2¾"



FM- 01-0128-01

Dissecting Needles EN

Sezieren Needles DE

Las agujas de disección ES

Dissection Aiguilles FR

Dissezione Aghi IT

01



SCALPEL

Microscopic needles



FM- 01-0129-13
13 cm/5"

FM- 01-0130-13
13 cm/5"



Microscopic needle holder

Kolle
FM- 01-0131-24
24 cm/ 9½"



Loop for needle holder

FM- 01-0132-06
6 cm/2¼"

Post mortem needles



FM- 01-0133-01

FM- 01-0133-02

FM- 01-0133-03

FM- 01-0133-04

FM- 01-0133-05

FM- 01-0133-06

EN Dissecting Set

DE Sezieren Set

ES Conjunto de disección

FR Ensemble dissection

IT Set dissezione

FAIZAN & MUSA
SPECIAL INSTRUMENTS

- 02 Dissecting Scissors FM- 01-0134-00
- 02 Dissecting Needles
- 01 Dressing Tweezers
- 01 Standard Tweezers
- 01 Scalpel Handle No. 4
- 01 Scalpel Blade



- 01 Dressing Scissors FM- 01-0135-00
- 01 Operating Scissors
- 01 Dressing Forceps
- 01 Tissue Forceps
- 02 Scalpel Handles
- 01 Mayo Needle Holder
- 02 Dissecting Needles



FM- 02-0204-00
 Battery handle



ber optic



FM- 02-0203-00
 Fig. 0
 for babies
 55 mm



FM- 02-0203-01
 Fig. 1
 for children
 70 mm



FM- 02-0203-02
 Fig. 2
 for adolescents
 80 mm

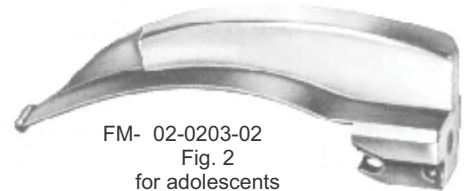

FM- 02-0203-03
 Fig. 3
 for women
 105 mm



FM- 02-0203-04
 Fig. 4
 for men
 130 mm

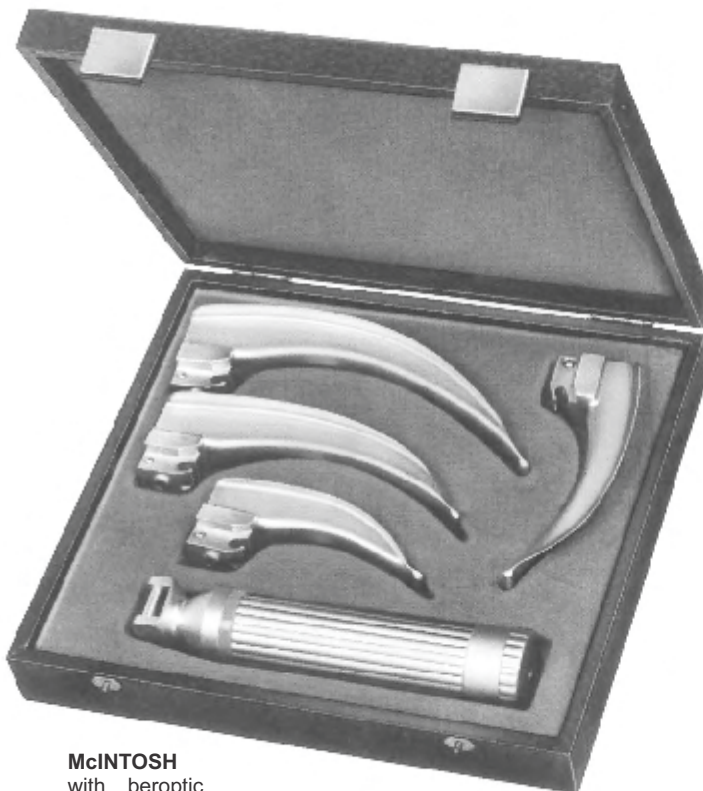

McINTOSH
 with ber optic

FM- 02-0201-00
 set with 4 blades, battery handle
 (without batteries)
 Fig. 1 to 4, in case

FM- 02-0202-00
 set with 3 blades, battery handle
 (without batteries)
 Fig. 1 to 3, in case



FAIZAN & MUSA
SPECIAL INSTRUMENTS

EN Anaesthesia

Page 12 to 16

DE Narkose

ES Anestesia

FR Anesthésie

IT Anestesia





FOREGGER
with fiber optic

FM- 02-0205-00
set with 4 blades, battery handle
(without batteries)
Fig. 1 to 4, in case

FM- 02-0205-01
set with 3 blades, battery handle
(without batteries)
Fig. 2 to 4, in case



FM- 02-0204-00
Battery handle

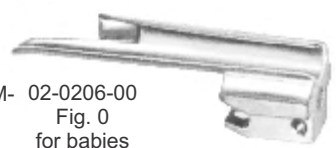

Laryngoscope Sets
fiber optic

FM- 02-0206-00
Fig. 0
for babies
55 mm

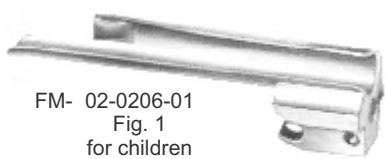

FM- 02-0206-01
Fig. 1
for children
70 mm



FM- 02-0206-02
Fig. 2
for adolescents
90 mm



FM- 02-0206-03
Fig. 3
for women
110 mm

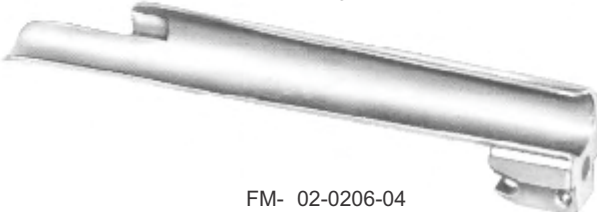

FM- 02-0206-04
Fig. 4
for men
135 mm



FOREGGER
FM- 02-207-00
set with 3 blades
Fig. 2 to 4, in case



FOREGGER
FM- 02-208-00
set with 4 blades
in case
Fig. 1 to 4, in case



FM- 02-209-01
Fig. 1
for children
70 mm

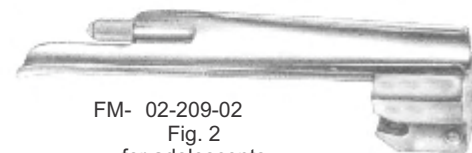

FM- 02-209-02
Fig. 2
for adolescents
90 mm



FM- 02-209-03
Fig. 3
for women
110 mm

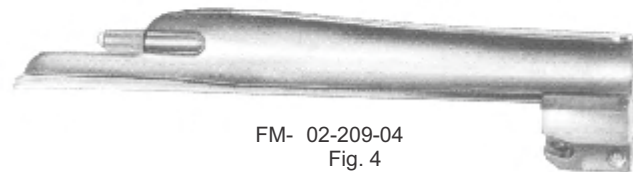

FM- 02-209-04
Fig. 4
for men
135 mm

Catheter Introducing Forceps, Suction Tubes **EN**
 Kathetereinführzangen, Sauger **DE**
 Pinzas para catéteres, Tubos de aspiración **ES**
 Cathéter introduisant la pince, tubes d'aspiration **FR**
 Catetere Introducendo pinze, tubi di aspirazione **IT**

02



ANAESTHESIA

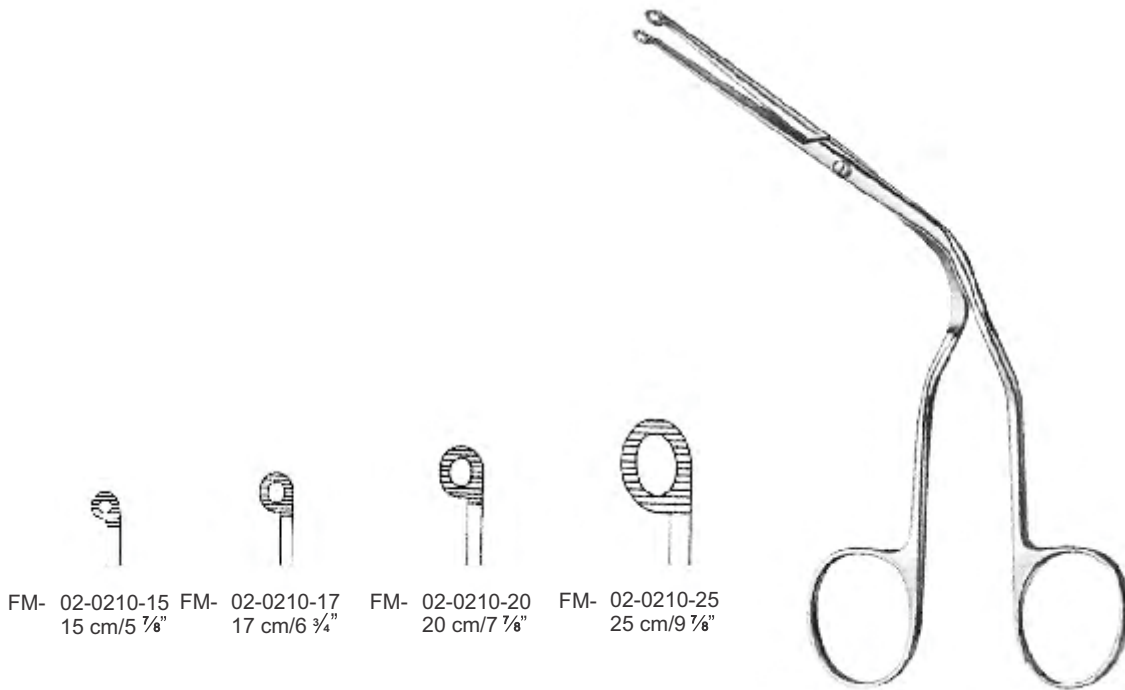

FM- 02-0210-15 15 cm/5 7/8" FM- 02-0210-17 17 cm/6 3/4" FM- 02-0210-20 20 cm/7 7/8" FM- 02-0210-25 25 cm/9 7/8"

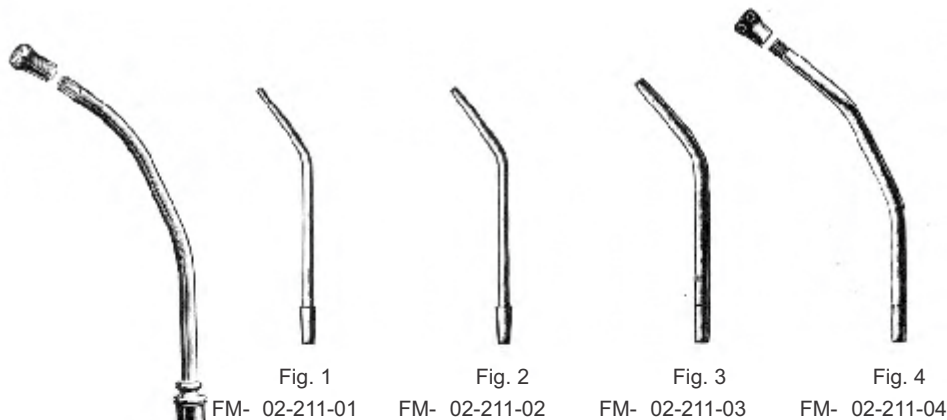
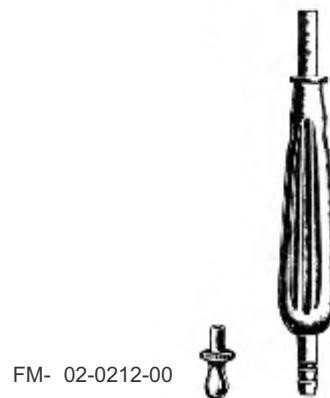

Fig. 1 FM- 02-211-01 Fig. 2 FM- 02-211-02 Fig. 3 FM- 02-211-03 Fig. 4 FM- 02-211-04



YANKAUER
 FM- 02-0211-31
 31 cm/12 1/4"
 with suction tip & connector



FM- 02-0212-00

YANKAUER
 FM- 02-0212-31
 (complete set)
 31 cm/12 1/4"

EN	Suction Tubes, Trocars
DE	Sauger, Trokare
ES	Tubos de aspiración, Trócares
FR	Tubes d'aspiration, Trocarts
IT	Tubi di aspirazione, trocar



ADSON
FM- 02-0213-21
21 cm/8 1/4"
4mm Ø



PLESTER
FM- 02-0214-01 1.5mm Ø
FM- 02-0214-02 2.0mm Ø
FM- 02-0214-03 2.5mm Ø
FM- 02-0214-04 3.0mm Ø
19.5 cm/7 3/4"



Charr.
6 FM- 02-0215-06
8 FM- 02-0215-08
10FM- 02-0215-10
12FM- 02-0215-12

POP PEN
13 cm/5 1/8"



Charr.
6 FM- 02-0216-06
7 FM- 02-0216-07
8 FM- 02-0216-08
9 FM- 02-0216-09
10 FM- 02-0216-10
11 FM- 02-0216-11
12 FM- 02-0216-12

FRAZIER
19 cm/7 1/2"



NELSON
21 cm/8 1/4"



Fig. 1
FM- 02-0217-01



Fig. 2
FM- 02-0217-02



Fig. 3
FM- 02-0217-03



Fig. 4
FM- 02-0217-04



UNIVERSAL
FM- 02-0218-30 Set of 3
FM- 02-0218-40 Set of 4



Ø 6



Ø 4.5



Ø 3



Ø 1.75 mm

EN	Diagnostics
DE	Diagnostik
ES	Diagnóstico
FR	Diagnostics
IT	Diagnostica

Page 17 to 20



EN	Percussion Hammers
DE	Perkussionshämmer
ES	Martillos de percusión
FR	Percussion Marteaux
IT	Percussione martelli



Taylor
FM- 03-0501-18 18.0cm
FM- 03-0501-20 20.0cm



Dejerine
FM- 03-0502-20 20.0cm



Dejerine
FM- 03-0503-21 21.0cm
FM- 03-0503-35 35.0cm



Neuro-Duo ex
FM- 03-0504-22 22.0cm

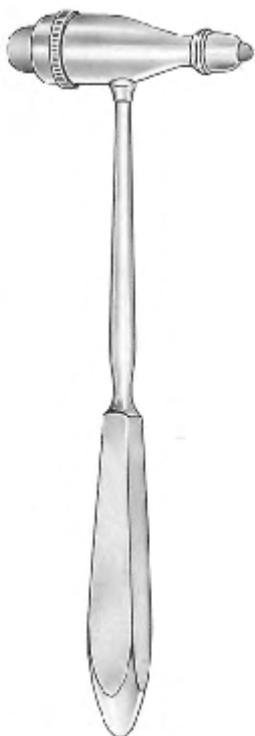

Troemner
FM- 03-0505-24 24.0cm



Berliner
FM- 03-0506-17 17cm/7"
FM- 03-0506-20 20cm/8"



Buck
FM- 03-0507-18 18.0cm



Buck (Telescopic)
FM- 03-0508-18 18.0cm

Percussion Hammers **EN**
 Perkussionshämmer **DE**
 Martillos de percusión **ES**
 Percussion Marteaux **FR**
 Percussione martelli **IT**

03



FAIZAN & MUSA
 SPECIAL INSTRUMENTS

DIAGNOSTICS



Traube
 FM- 03-0509-16
 16 cm/6 1/4"



Troemner
 FM- 03-0510-21
 21 cm/8 1/4"



Divers-Duo ex
 FM- 03-0511-22
 22 cm/8 3/4"



Babinsky
 FM- 03-0512-22 22 cm/8 3/4"
 FM- 03-0512-25 25 cm/10"



Rabiner
 FM- 03-0513-23
 23 cm/9 1/4"



National Hospital
 FM- 03-0514-50 50 mm Ø
 FM- 03-0514-60 60 mm Ø
 FM- 03-0514-70 70 mm Ø
 33 cm/13"



Queen Sqaure
 FM- 03-0515-26
 26 cm/10 1/4"



Pinard
 FM- 03-0516-18
 18.0cm
 (wooden)



Pinard
 FM- 03-0517-15
 15.0cm
 (plastic)



Pinard
 FM- 03-0518-15
 15.0cm
 (aluminum)



Pinard
 FM- 03-0519-15
 15.0cm
 (aluminum)



Aly
 FM- 03-0520-17
 17cm/6¾"



Wartenberg
 FM- 03-0521-19
 19cm/7½"



Weber
 FM- 03-0522-09
 9cm/3½"



FM- 03-0523-15 15.0cm
 FM- 03-0523-30 30.0cm
 FM- 03-0523-60 60.0cm

Available in conventional and beroptic



FM- 03-0524-00
Otoscope set in Case



FM- 03-0525-00
Otoscope set in Pouch



FM- 03-0526-00
Ophthalmoscope set



FM- 03-0527-00
Ophthalmoscope and Otoscope set



FM- 03-0528-00
Complete ENT set

EN	Scissors	Page 21 to 45
DE	Scheren	
ES	Tijeras	
FR	Les ciseaux	
IT	Forbici	



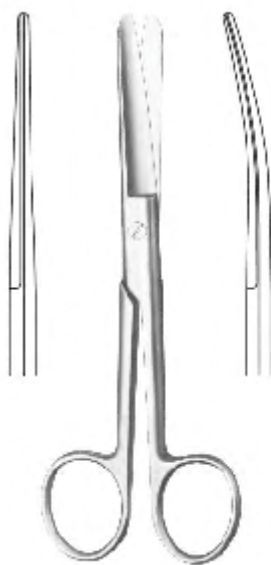

STANDARD
blunt/blunt

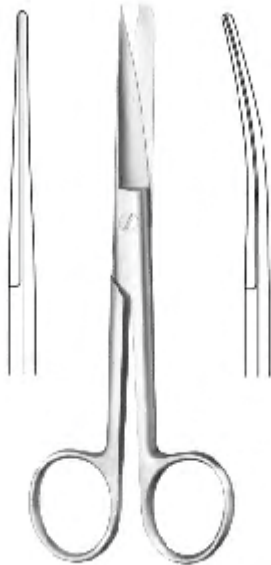

STANDARD
sharp/blunt

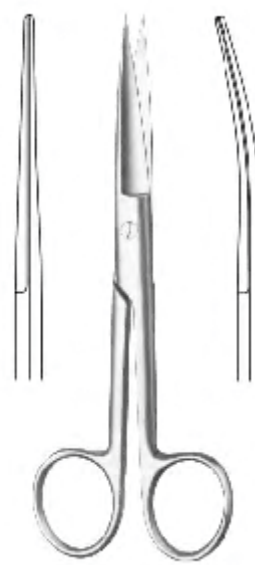

STANDARD
sharp/sharp

cm	in	STANDARD blunt/blunt		STANDARD sharp/blunt		STANDARD sharp/sharp	
		Straight	Curved	Straight	Curved	Straight	Curved
10.5	4 1/8"	FM- 04-0701-10	FM- 04-0702-10	FM- 04-0703-10	FM- 04-0704-10	FM- 04-0705-10	FM- 04-0706-10
11.5	4 1/2"	FM- 04-0701-11	FM- 04-0702-11	FM- 04-0703-11	FM- 04-0704-11	FM- 04-0705-11	FM- 04-0706-11
13.0	5 1/8"	FM- 04-0701-13	FM- 04-0702-13	FM- 04-0703-13	FM- 04-0704-13	FM- 04-0705-13	FM- 04-0706-13
14.5	5 3/4"	FM- 04-0701-14	FM- 04-0702-14	FM- 04-0703-14	FM- 04-0704-14	FM- 04-0705-14	FM- 04-0706-14
15.5	6 1/8"	FM- 04-0701-15	FM- 04-0702-15	FM- 04-0703-15	FM- 04-0704-15	FM- 04-0705-15	FM- 04-0706-15
16.5	6 1/2"	FM- 04-0701-16	FM- 04-0702-16	FM- 04-0703-16	FM- 04-0704-16	FM- 04-0705-16	FM- 04-0706-16
17.5	6 7/8"	FM- 04-0701-17	FM- 04-0702-17	FM- 04-0703-17	FM- 04-0704-17	FM- 04-0705-17	FM- 04-0706-17
18.5	7 1/4"	FM- 04-0701-18	FM- 04-0702-18	FM- 04-0703-18	FM- 04-0704-18	FM- 04-0705-18	FM- 04-0706-18
20.0	7 7/8"	FM- 04-0701-20	FM- 04-0702-20	FM- 04-0703-20	FM- 04-0704-20	FM- 04-0705-20	FM- 04-0706-20

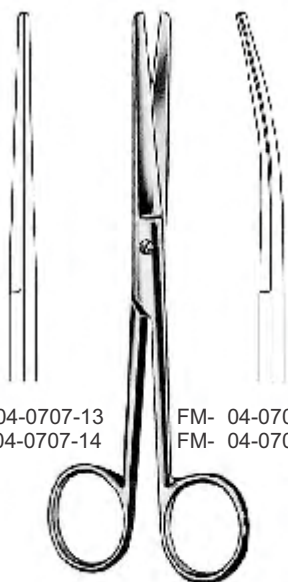

GRAZIL
blunt/blunt

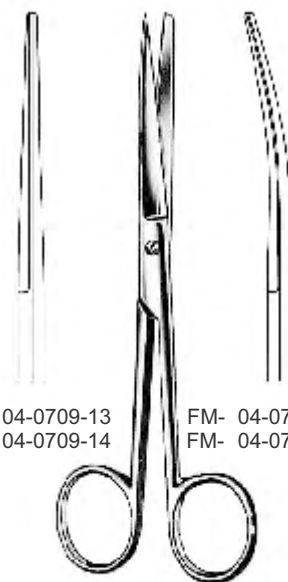

GRAZIL
sharp/blunt

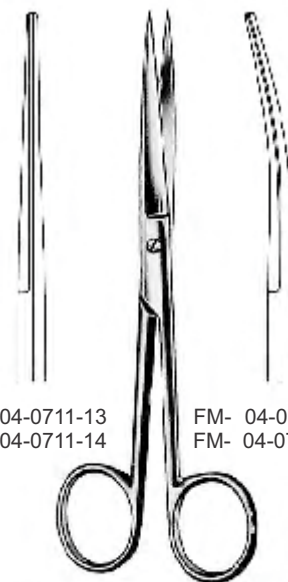

GRAZIL
sharp/sharp

cm	in								
13.0	5 1/8"	FM- 04-0707-13	FM- 04-0708-13	FM- 04-0709-13	FM- 04-0710-13	FM- 04-0711-13	FM- 04-0712-13		
14.5	5 3/4"	FM- 04-0707-14	FM- 04-0708-14	FM- 04-0709-14	FM- 04-0710-14	FM- 04-0711-14	FM- 04-0712-14		



INCISION
 FM- 04-0713-13 13 cm/5 1/8"
 FM- 04-0713-14 14.5 cm/5 3/4"



FM- 04-0714-14
 Straight

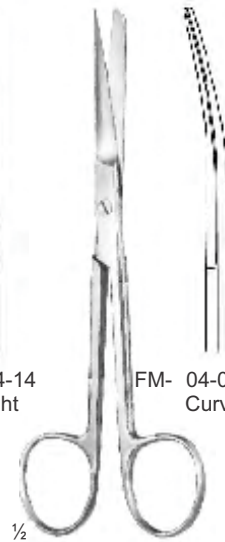

FM- 04-0715-14
 Curved

1/2
DEAVER
 14 cm/5 1/2"

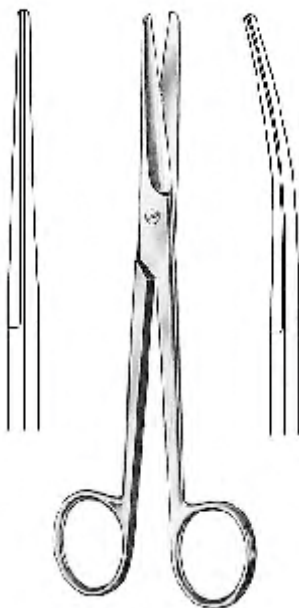

MAYO

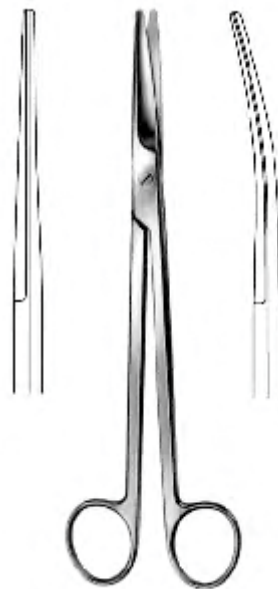

MAYO-HARRINGTON

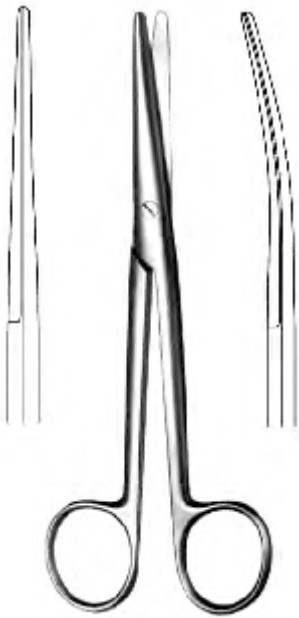

MAYO-STILLE

straight		curved	straight	curved	straight	curved
FM- 04-0716-14	14.5 cm/5 3/4"	FM- 04-0717-14	FM- 04-0718-23	23 cm/9"	FM- 04-0719-23	FM- 04-0720-15
FM- 04-0716-15	15 cm/5 7/8"	FM- 04-0717-15	FM- 04-0718-28	28 cm/11"	FM- 04-0719-28	FM- 04-0720-16
FM- 04-0716-17	17 cm/6 3/4"	FM- 04-0717-17				FM- 04-0720-17
FM- 04-0716-23	23 cm/9"	FM- 04-0717-23				FM- 04-0720-19
						FM- 04-0720-21
						FM- 04-0720-21
						FM- 04-0721-15
						FM- 04-0721-16
						FM- 04-0721-17
						FM- 04-0721-19
						FM- 04-0721-21

SCISSORS



DUBOIS
 FM- 04-0725-27
 27 cm/10 1/2"
 Straight



FM- 04-0726-27
 Curved

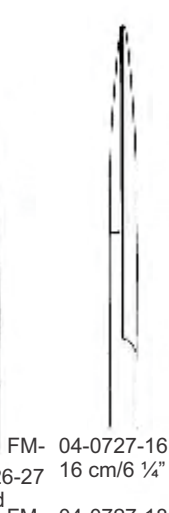

FM- 04-0727-16
 16 cm/6 1/4"

FM- 04-0727-18
 18 cm/7 1/8"
 Straight

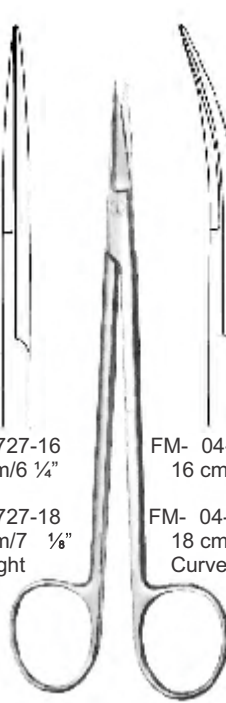

KELLY

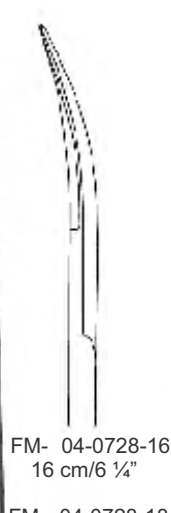

FM- 04-0728-16
 16 cm/6 1/4"

FM- 04-0728-18
 18 cm/7 1/8"
 Curved

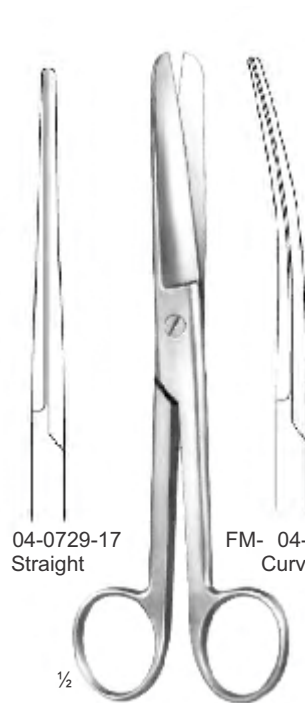

DOYEN
 17.5 cm/6 7/8"

04-0729-17
 Straight



FM- 04-0730-17
 Curved



METZENBAUM BABY
 FM- 04-0731-11
 11.5 cm/4 1/2"
 Straight

FM- 04-0732-11
 Curved



FM- 04-0733-14
 Straight

METZENBAUM
 14.5 cm/5 3/4"
 blunt/blunt

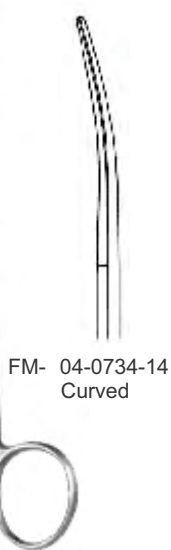

FM- 04-0734-14
 Curved



FM- 04-0735-14
 Straight

METZENBAUM
 14.5 cm/5 3/4"
 sharp/blunt



FM- 04-0736-14
 Curved



FM- 04-0737-14
 Straight

METZENBAUM
 14.5 cm/5 3/4"
 sharp/sharp



FM- 04-0738-14
 Curved

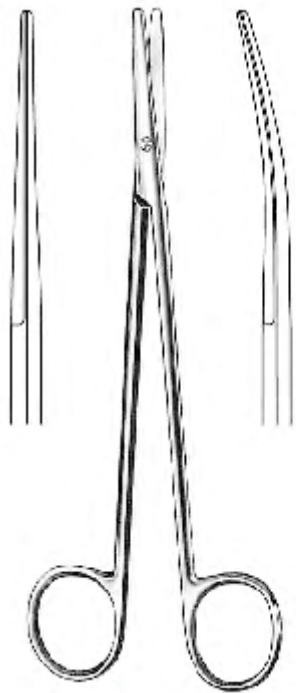

METZENBAUM-NELSON
blunt/blunt

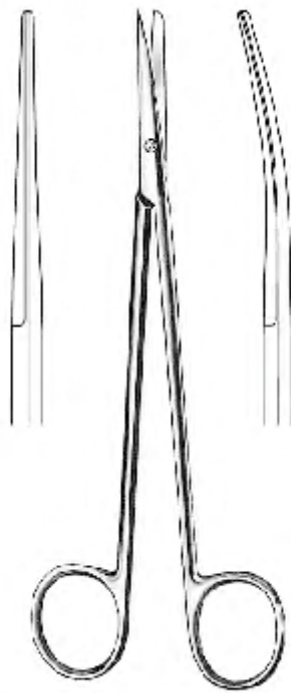

METZENBAUM-NELSON
sharp/blunt

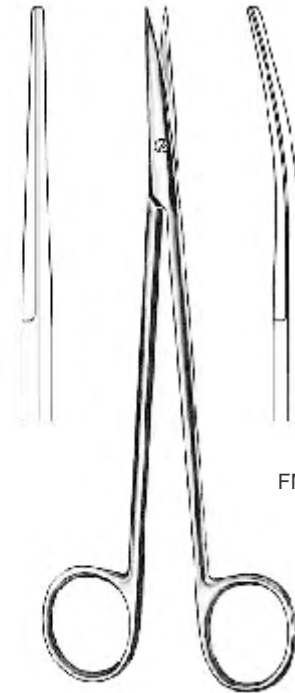

METZENBAUM-NELSON
sharp/sharp

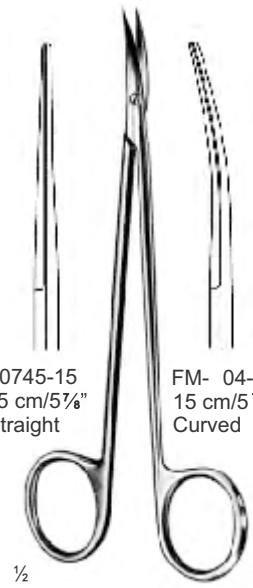

NERVE DISSECTING SCISSORS

FM- 04-0745-15
15 cm/5 7/8"
Straight

FM- 04-0746-15
15 cm/5 7/8"
Curved

cm	in	straight	curved	straight	curved	straight	curved
18	7 1/8"	FM- 04-0739-18	FM- 04-0740-18	FM- 04-0741-18	FM- 04-0742-18	FM- 04-0743-18	FM- 04-0744-18
20	7 7/8"	FM- 04-0739-20	FM- 04-0740-20	FM- 04-0741-20	FM- 04-0742-20	FM- 04-0743-20	FM- 04-0744-20
23	9"	FM- 04-0739-23	FM- 04-0740-23	FM- 04-0741-23	FM- 04-0742-23	FM- 04-0743-23	FM- 04-0744-23
25	9 3/4"	FM- 04-0739-25	FM- 04-0740-25	FM- 04-0741-25	FM- 04-0742-25	FM- 04-0743-25	FM- 04-0744-25
28	11"	FM- 04-0739-28	FM- 04-0740-28	FM- 04-0741-28	FM- 04-0742-28	FM- 04-0743-28	FM- 04-0744-28
30	11 3/4"	FM- 04-0739-30	FM- 04-0740-30	FM- 04-0741-30	FM- 04-0742-30	FM- 04-0743-30	FM- 04-0744-30

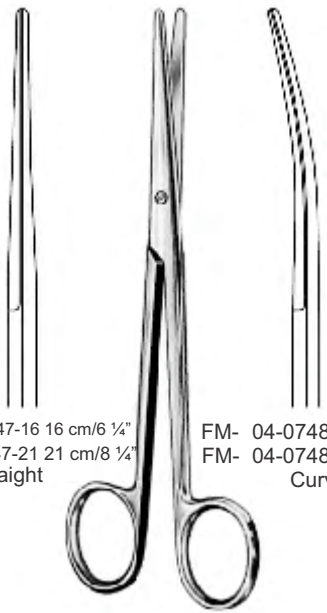

LEXER

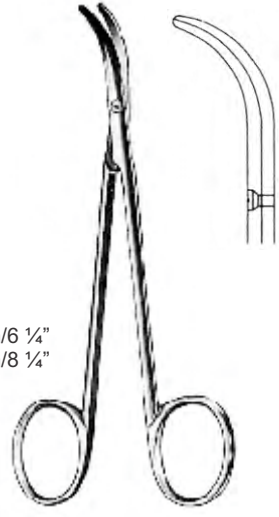

FOMON
FM- 04-0749-13
13.5 cm/5 3/8"

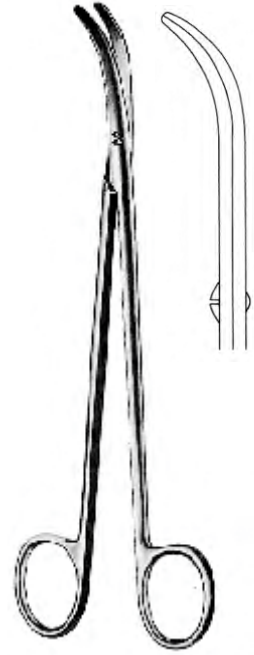

THOREK
FM- 04-0750-19
19 cm/7 1/2"

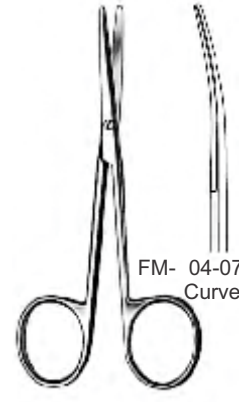

LEXER-BABY
FM- 04-0751-10
10 cm/3 7/8"

FM- 04-0747-16 16 cm/6 1/4"
FM- 04-0747-21 21 cm/8 1/4"
Straight

FM- 04-0748-16 16 cm/6 1/4"
FM- 04-0748-21 21 cm/8 1/4"
Curved

FM- 04-0752-10
Curved

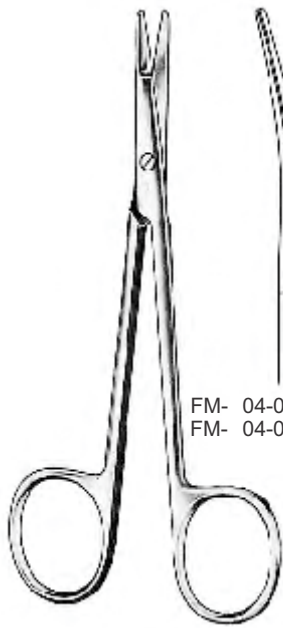

KILNER
 FM- 04-0753-13
 13 cm/5 1/8"

FM- 04-0754-12 12 cm/4 3/4"
 FM- 04-0754-15 15 cm/5 7/8"



CRAFOORD
 FM- 04-0755-30
 30 cm/11 3/4"



SATINSKY
 FM- 04-0756-24
 24.5 cm/9 5/8"

Dissecting Scissors **EN**

Präparierscheren **DE**

Tijeras de disección **ES**

Ciseaux de fonctionnement **FR**

Forbici operative **IT**

04



FAIZAN & MUSA
SPECIAL INSTRUMENTS

SCISSORS



1/2

POTTS-SMITH
19 cm/7 1/2"



25°

FM- 04-0757-19

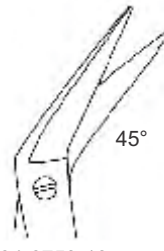

45°

FM- 04-0759-19

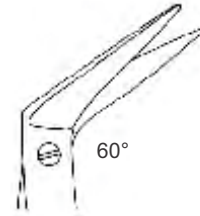

60°

FM- 04-0758-19



DEBAKEY



25°

16 cm/6 1/4" FM- 04-0760-16
23 cm/9" FM- 04-0760-23
28 cm/11" FM- 04-0760-28

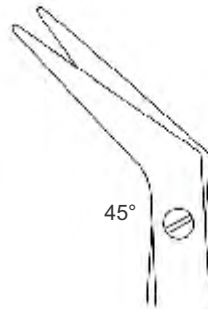

45°

FM- 04-0761-16
FM- 04-0761-23
FM- 04-0761-28

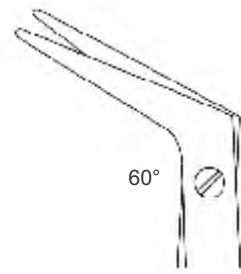

60°

FM- 04-0762-16
FM- 04-0762-23
FM- 04-0762-28

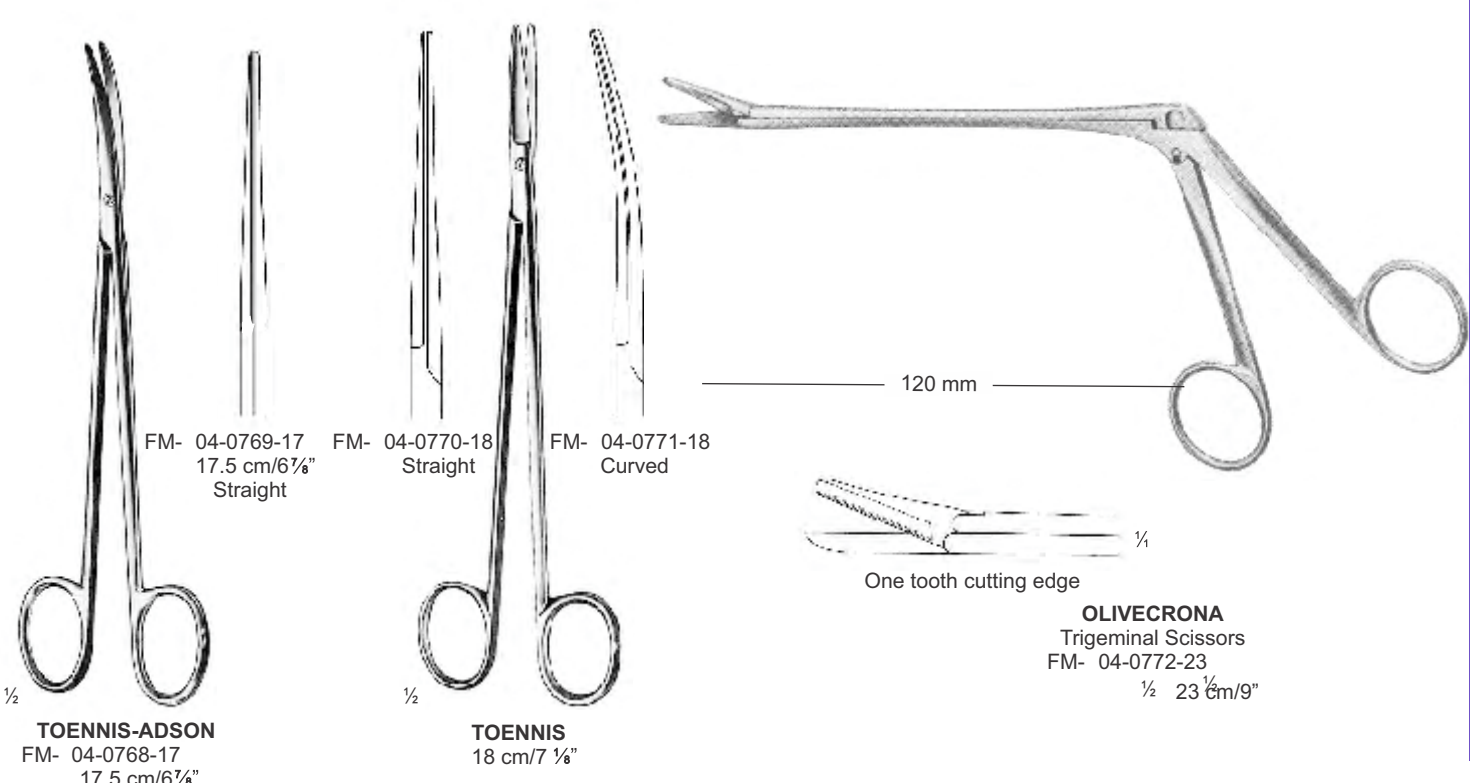
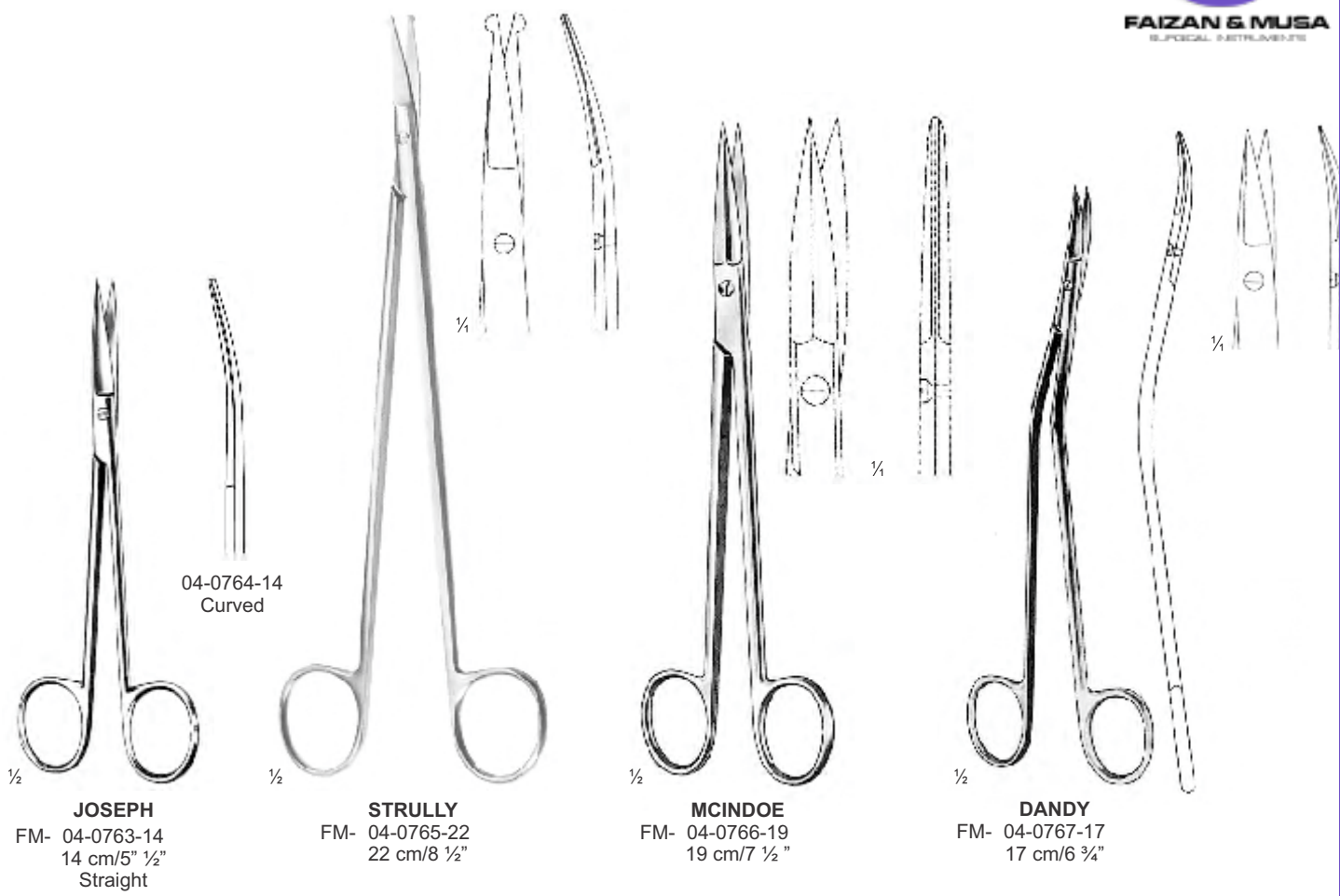

Tonsil and Nasal Scissors **EN**

Tonsillen-und-Nasenscheren **DE**

Tijeras nasales y para amígdalas **ES**

Ciseaux amygdales et nasaux **FR**

Tonsilla e forbici nasali **IT**

04



FAIZAN & MUSA
SPECIAL INSTRUMENTS

SCISSORS

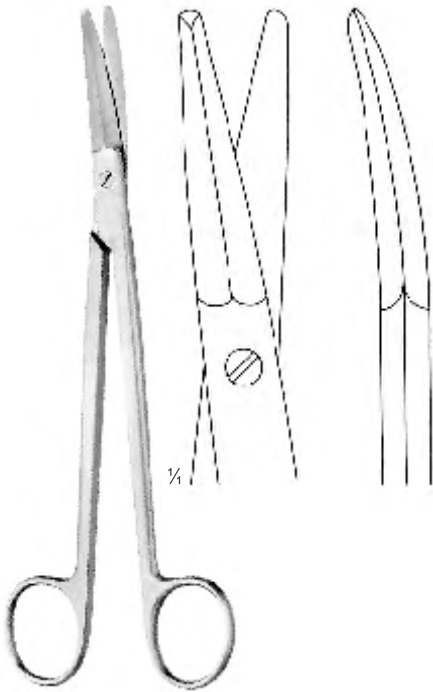

BOETTCHER
FM- 04-0776-18
18 cm/7 1/8"

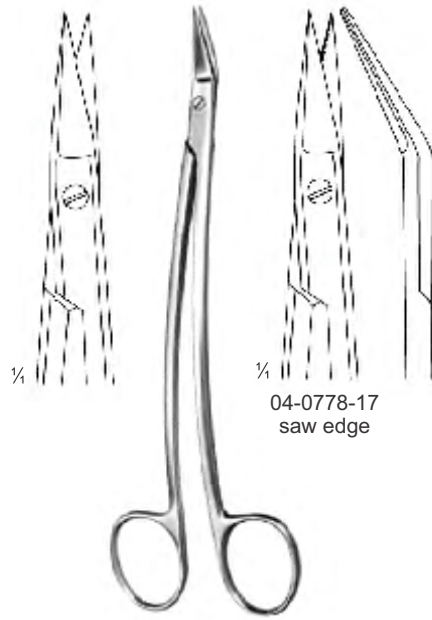

DEAN
FM- 04-0777-17
17 cm/6 3/4"

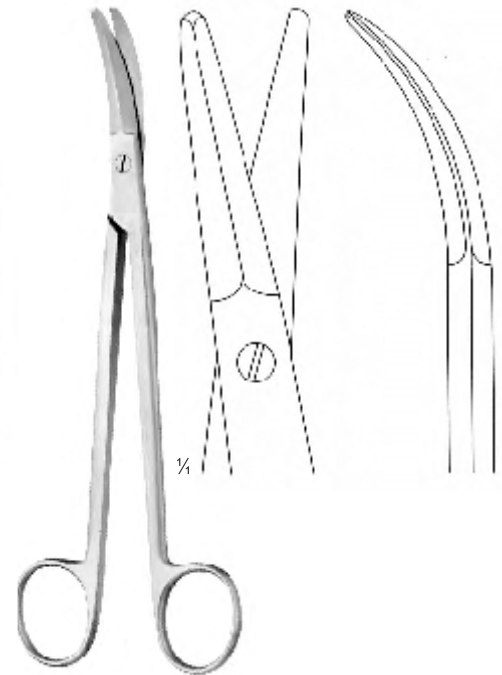

PRINCE
FM- 04-0779-17
17.5 cm/6 7/8"



HEYMANN
FM- 04-0780-18
18 cm/7 1/8"



COTTLE
FM- 04-0781-16
16 cm/6 1/4"



FOMON
FM- 04-0782-15
15 cm/5 7/8"



BRAUN-STADLER
 FM- 04-0783-14
 14.5 cm/5 3/4"

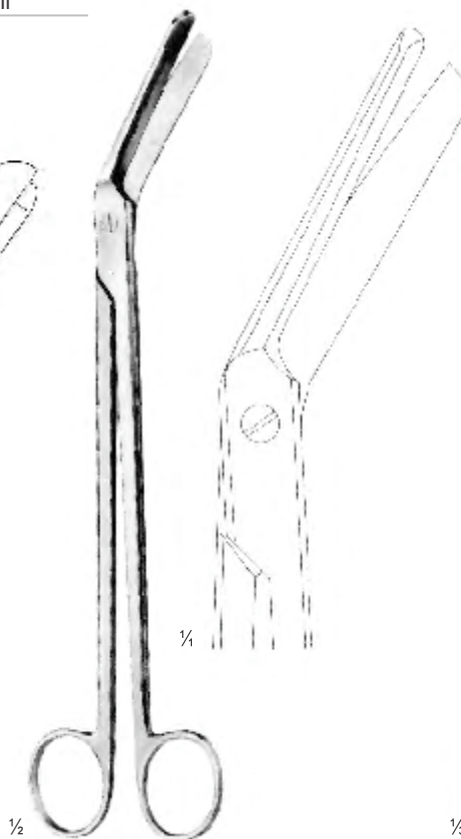

BRAUN-STADLER
 FM- 04-0784-22
 22 cm/8 1/2"

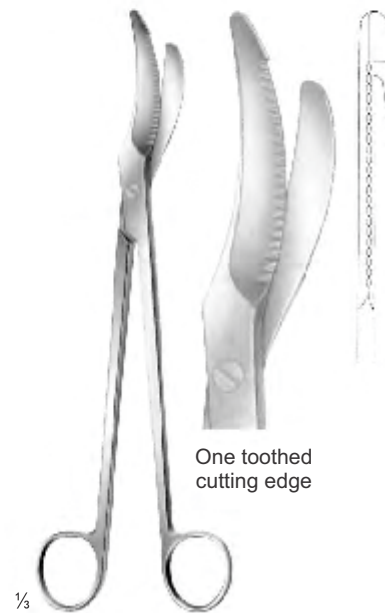

FM- 04-0785-24
 Episiotomy Scissors
 24 cm/9 1/2"

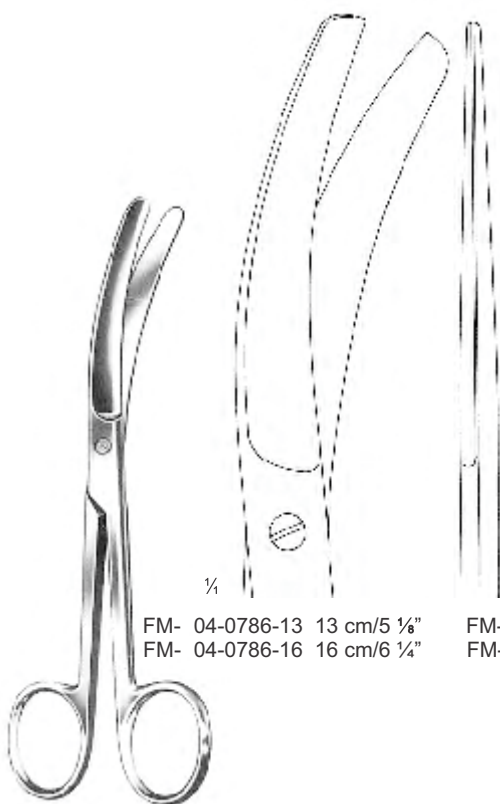

FM- 04-0786-13 13 cm/5 1/8"
 FM- 04-0786-16 16 cm/6 1/4"

BUSCH

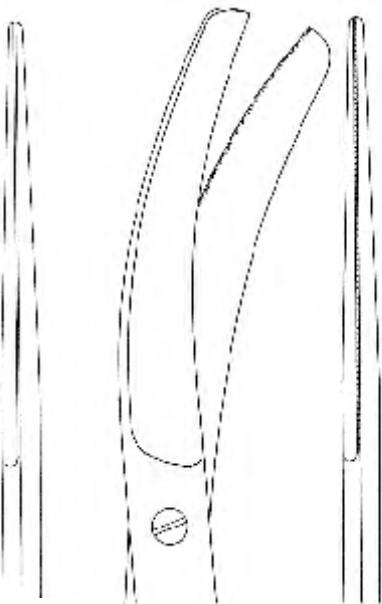

FM- 04-0787-13 13 cm/5 1/8"
 FM- 04-0787-16 16 cm/6 1/4"
 One tooth cutting edge

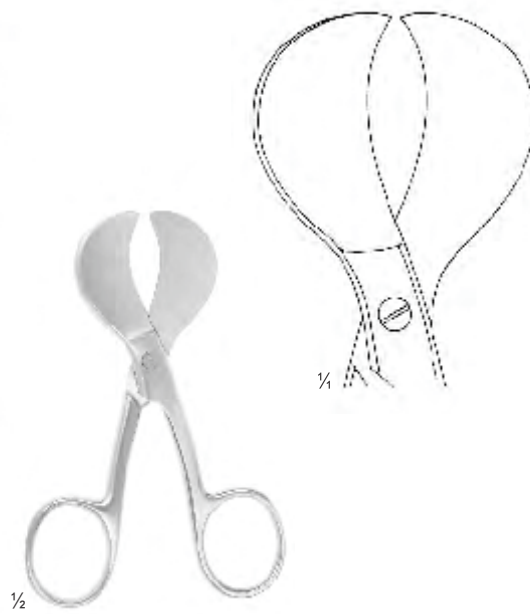

MOD. USA
 FM- 04-0788-10
 10.5 cm/4 1/8"



FAIZAN & MUSA
 SPECIAL INSTRUMENTS

SCISSORS

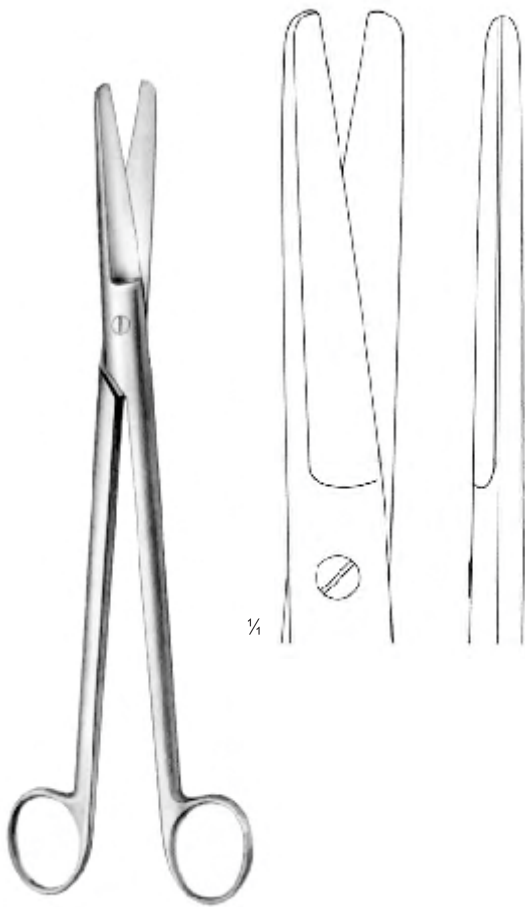

SIMS-SIEBOLD
 straight
 FM- 04-0796-24
 24 cm/9 1/2"

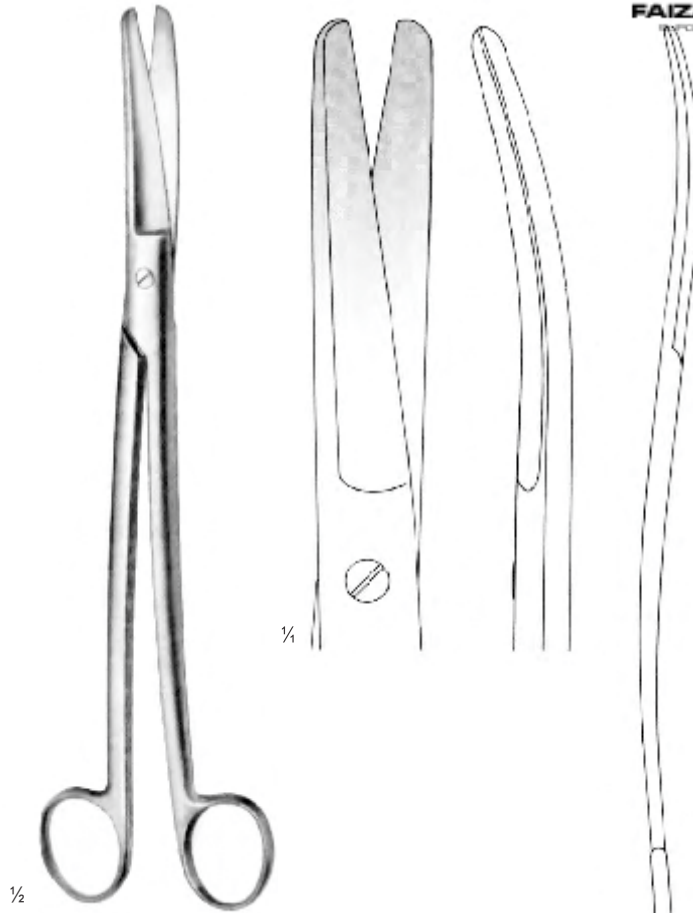

SIMS-SIEBOLD
 S-Shaped
 FM- 04-0797-24
 24 cm/9 1/2"

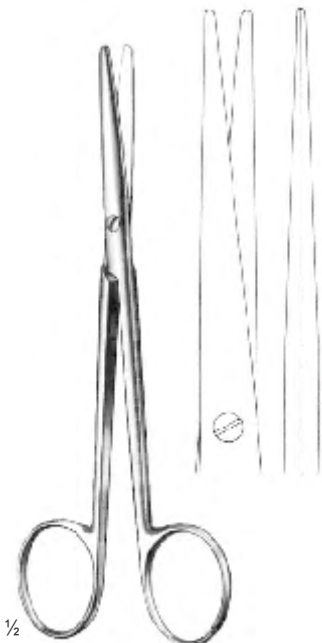

LEXER-FINO
 FM- 04-0798-16
 16 cm/6 1/4"
 Straight

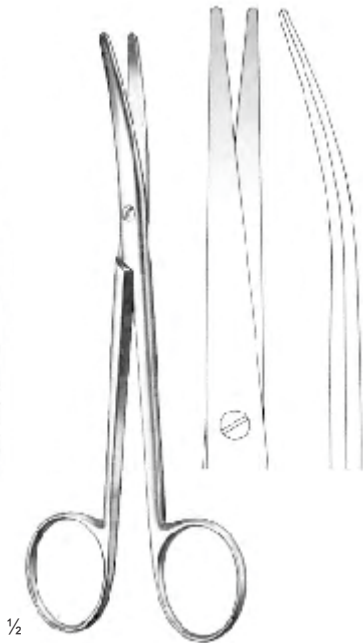

LEXER-FINO
 FM- 04-0799-16
 16 cm/6 1/4"
 Curved



METZENBAUM-FINO
 FM- 04-0800-14
 14.5 cm/5 3/4"
 Straight

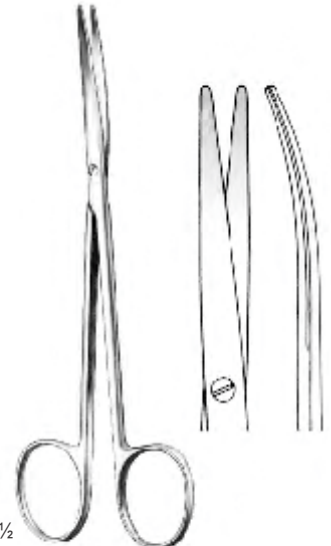

METZENBAUM-FINO
 FM- 04-0801-14
 14.5 cm/5 3/4"
 Curved

SCISSORS

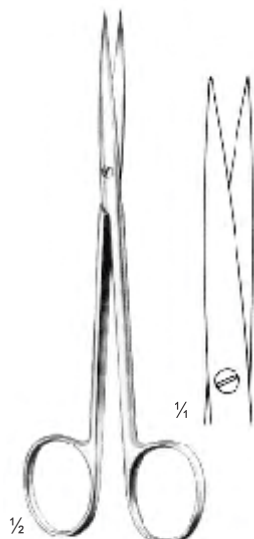

METZENBAUM-FINO
 FM- 04-0802-14
 14.5 cm/5 3/4"
 Straight
 Sharp/Sharp

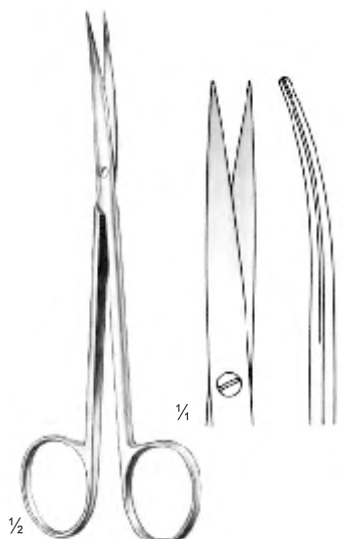

METZENBAUM-FINO
 FM- 04-0803-14
 14.5 cm/5 3/4"
 Curved
 Sharp/Sharp

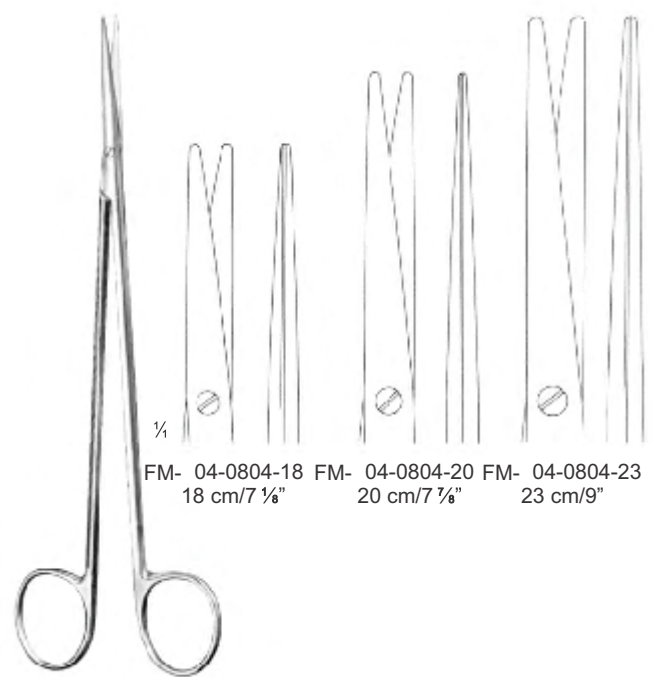

FM- 04-0804-18 18 cm/7 1/8"
 FM- 04-0804-20 20 cm/7 7/8"
 FM- 04-0804-23 23 cm/9"

METZENBAUM-FINO

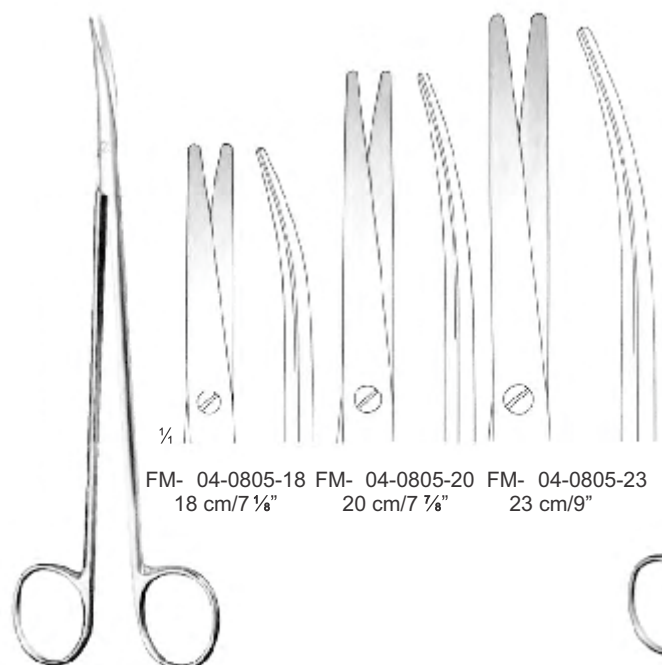

FM- 04-0805-18 18 cm/7 1/8"
 FM- 04-0805-20 20 cm/7 7/8"
 FM- 04-0805-23 23 cm/9"

METZENBAUM-FINO

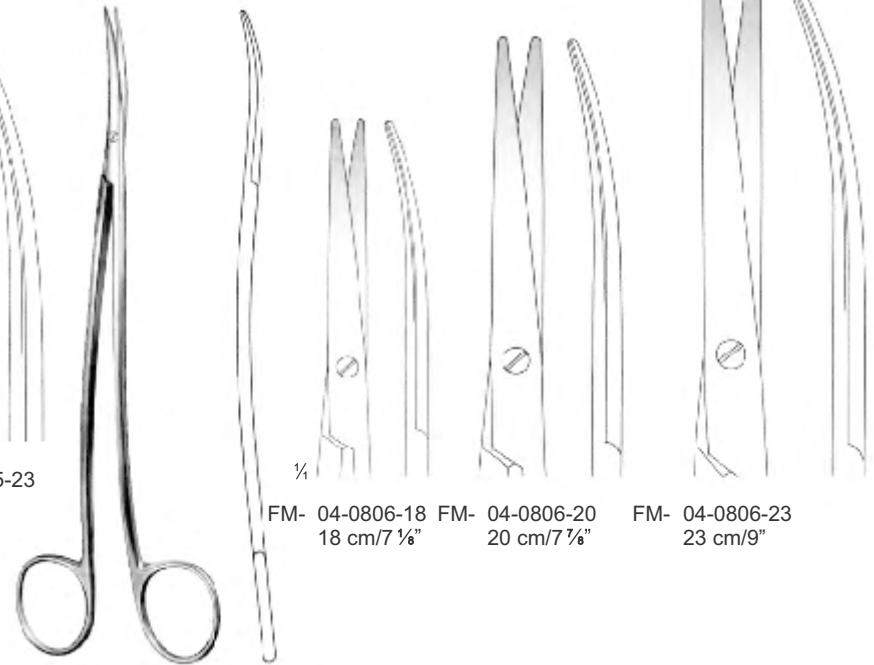

FM- 04-0806-18 18 cm/7 1/8"
 FM- 04-0806-20 20 cm/7 7/8"
 FM- 04-0806-23 23 cm/9"

**METZENBAUM-FINO
 S-SHAPED**



FAIZAN & MUSA
SPECIAL INSTRUMENTS

04

Ligature Scissors, Nail Splitting Scissors **EN**
 Ligaturscheren, Nagelschere **DE**
 Tijeras para ligaduras, Tijeras de uñas Splitting **ES**
 Ciseaux à ligatures, ciseaux à fendre les ongles **FR**
 Forbici per legature, forbici per spaccare le unghie **IT**

SCISSORS



¼

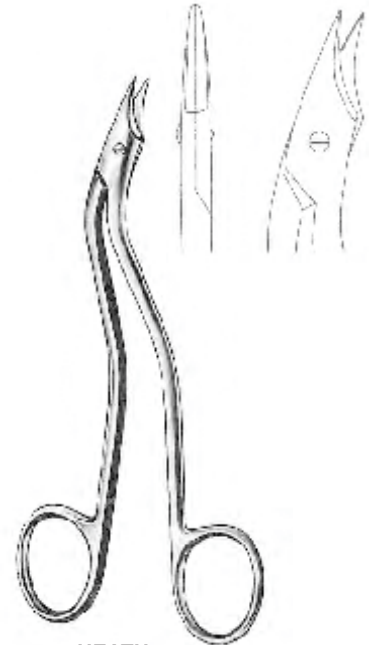
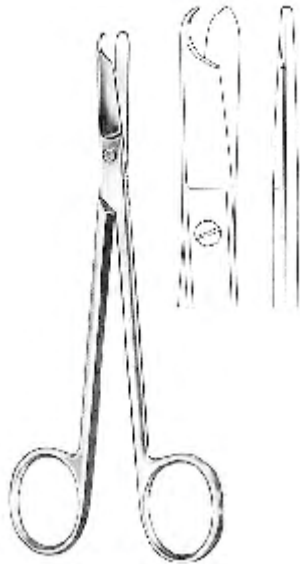

SPENCER
 FM- 04-0807-09 9 cm/3 ½"
 FM- 04-0807-10 10.5 cm/4 ¼"
 FM- 04-0807-13 13 cm/5 ¼"

LITTAUER
 FM- 04-0808-14
 14 cm/5 ½"

BUCK
 FM- 04-0809-14
 14.5 cm/5 ¾"

HEATH
 FM- 04-0810-15
 15 cm/5 7/8"



¼

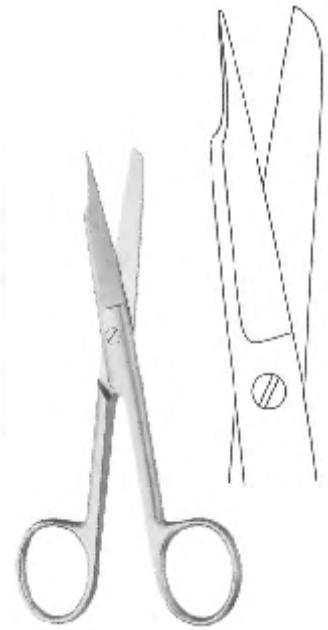
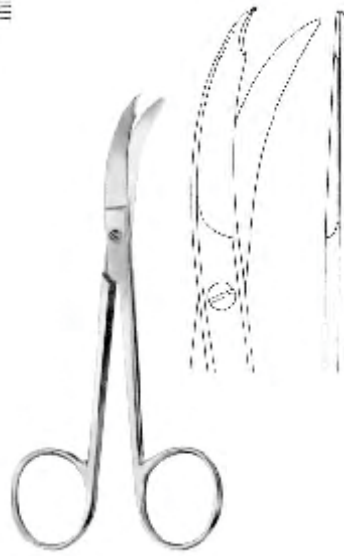

SCHOEMAKER-LOTH
 FM- 04-0811-13
 13 cm/5 ¼"

EISELSBERG
 FM- 04-0812-12
 12 cm/4 ¾"

NORTHBENT
 FM- 04-0813-09 9 cm/3 ½"
 FM- 04-0813-12 12.5 cm/4 7/8"

NAIL SPLITTING SCISSORS
 FM- 04-0814-13 13 cm/5 ¼"
 FM- 04-0814-15 15 cm/5 7/8"

SCISSORS

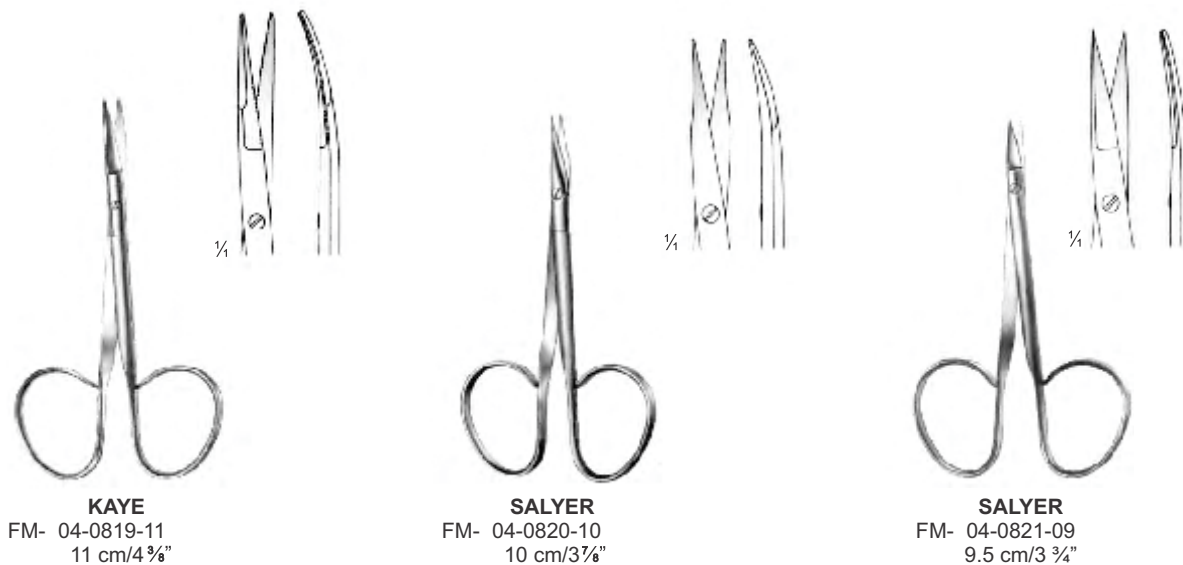
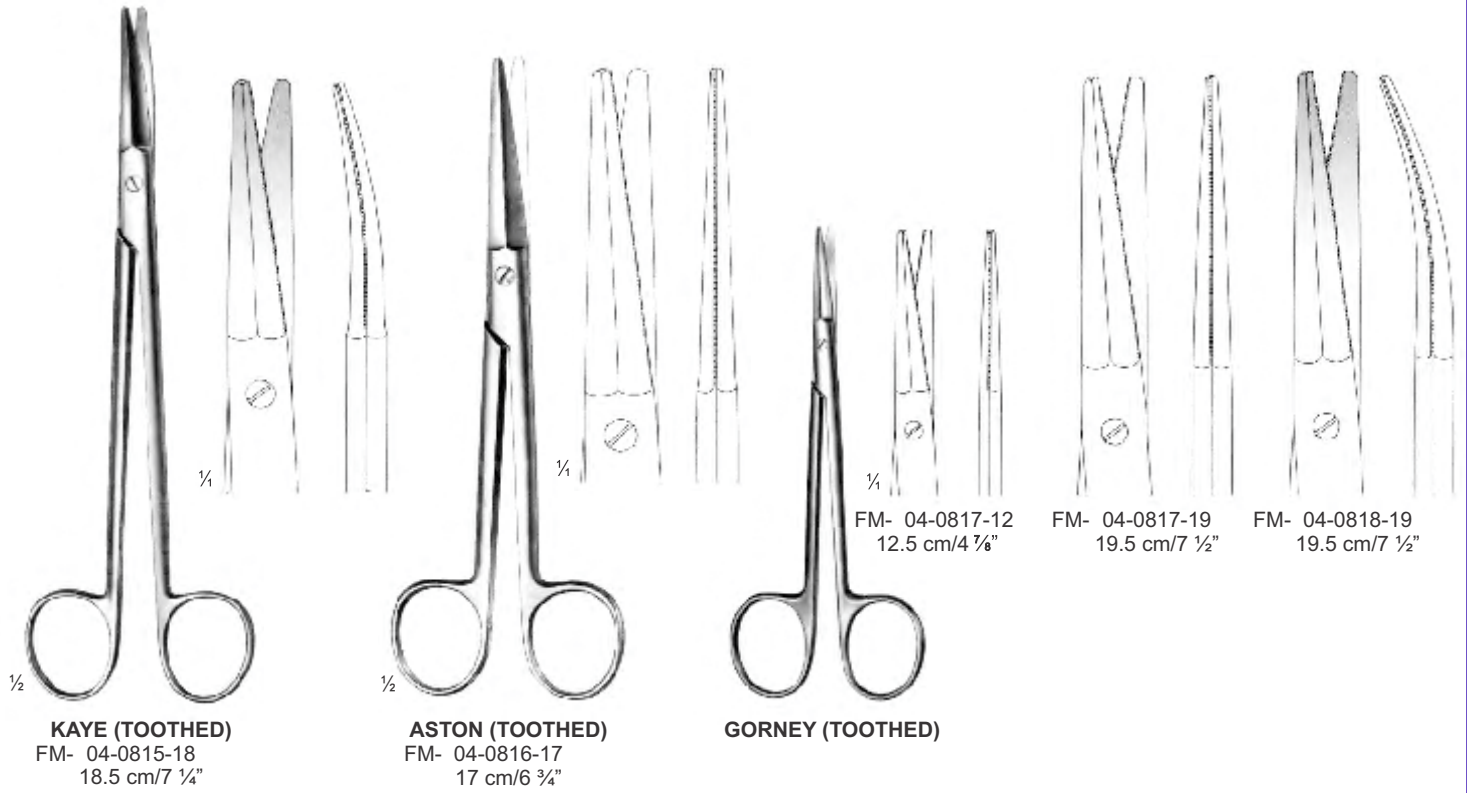



IRIS

Straight Curved
 9 cm/3 1/2" FM- 04-0822-09 FM- 04-0823-09
 10.5 cm/4 1/8" FM- 04-0822-10 FM- 04-0823-10
 11.5 cm/4 1/2" FM- 04-0822-11 FM- 04-0823-11

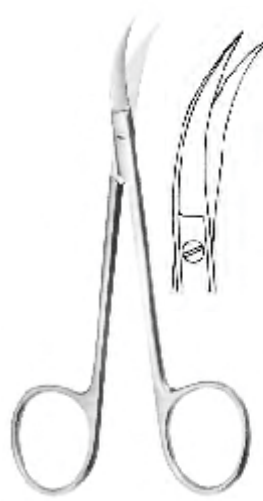

IRIS-FINE

FM- 04-0824-11
 11.5 cm/4 1/2"



IRIS-FINE

FM- 04-0825-11
 11.5 cm/4 1/2"
 angled

Pointed

Blunt



curved

FM- 04-0827-11



straight

FM- 04-0828-11

straight

FM- 04-0826-11

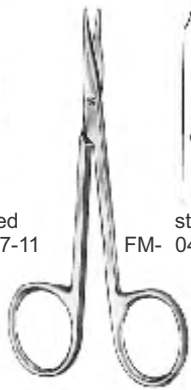

STEVENS-TENOTOMY

11.5 cm/4 1/2"

curved

FM- 04-0829-11



FM- 04-0830-11
 Straight

FM- 04-0831-11
 Curved



STABISMUS

11.5 cm/4 1/2"

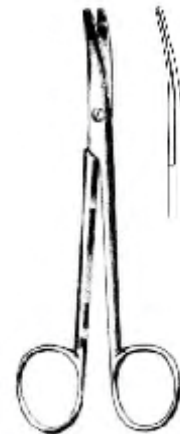

ENUCLEATION

FM- 04-0832-11
 11 cm/4 3/8"

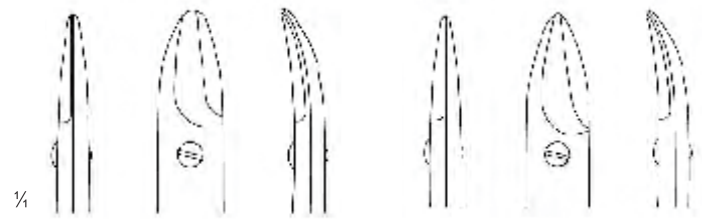

FM- 04-0835-10 Blunt FM- 04-0836-10 FM- 04-0837-10 Sharp FM- 04-0838-10

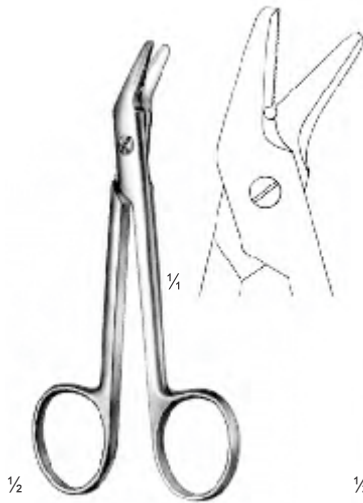

UNIVERSAL
 FM- 04-0833-12
 12 cm/4 3/4"
 one saw edge



FM- 04-0834-10
 10 cm/3 7/8"
 saw edge

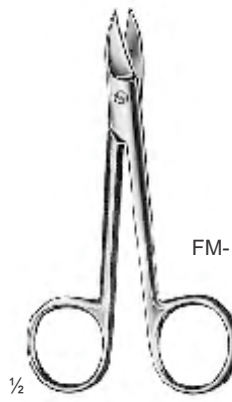

BEEBEE
 10.5 cm/4 1/8"

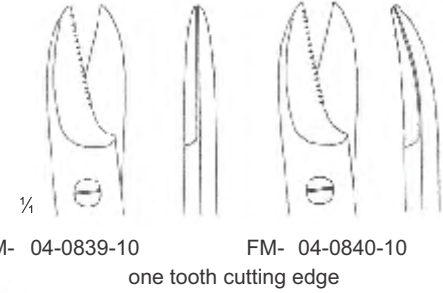

FM- 04-0839-10 FM- 04-0840-10
 one tooth cutting edge

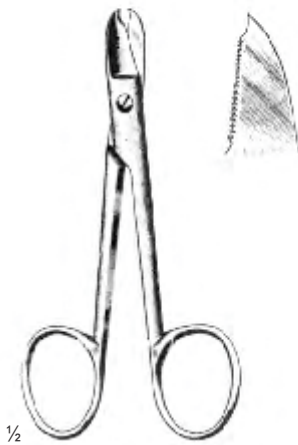

04-0841-12
 12 cm/4 3/4"
 saw edge



04-0842-10
 10.5 cm/4 1/8"
 saw edge



04-0843-15
 15.5 cm/6 1/8"
 saw edge

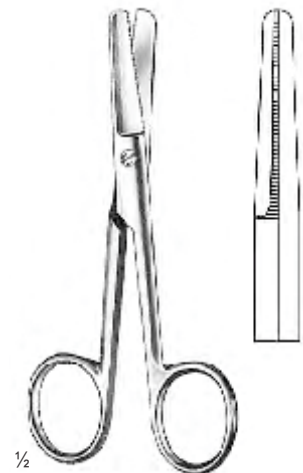

HARVEY
 04-0844-12
 12.5 cm/4 7/8"

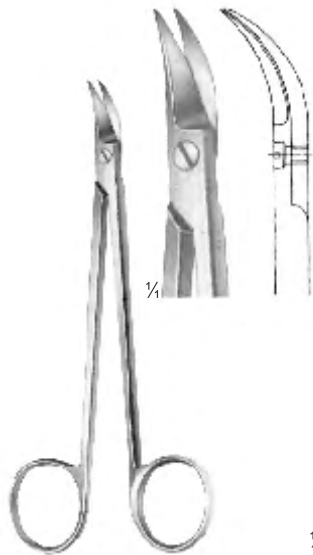

QUINBY
 FM- 04-0853-12
 12.5 cm/4 7/8"



NEUMANN
 FM- 04-0854-12
 12 cm/4 3/4"

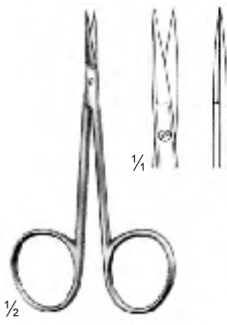

FM- 04-0855-08
 8 cm/3 1/4"
 delicate

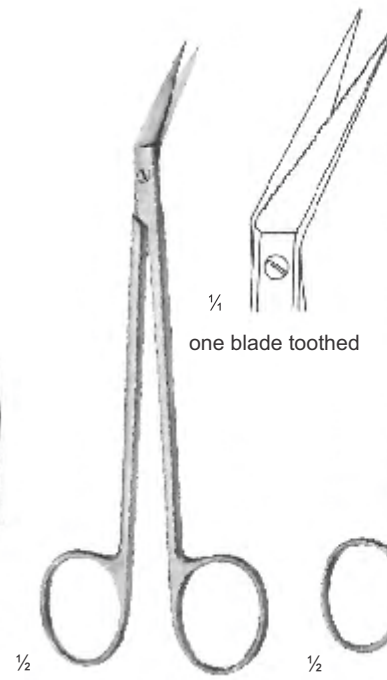

LOCKLIN
 FM- 04-0856-16
 16 cm/6 1/4"

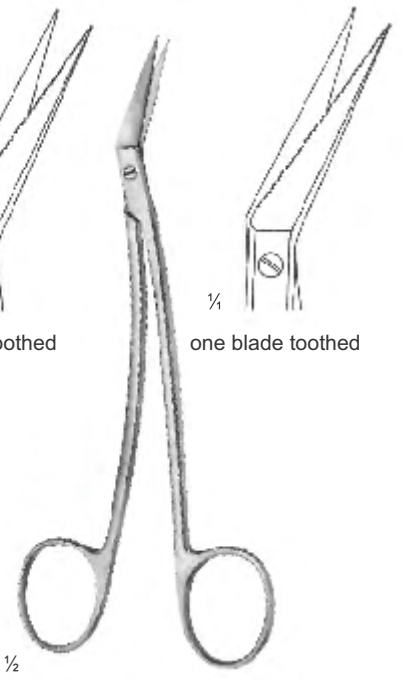

LOCKLIN
 FM- 04-0857-16
 16 cm/6 1/4"

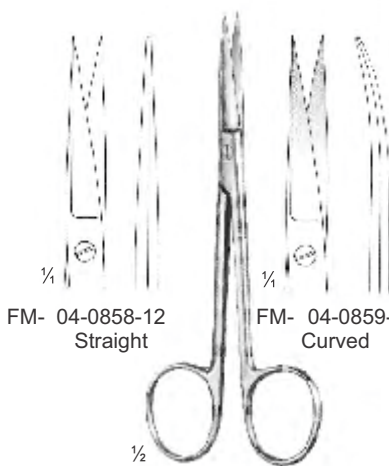

FM- 04-0858-12
 Straight

WAGNER
 12 cm/4 3/4"

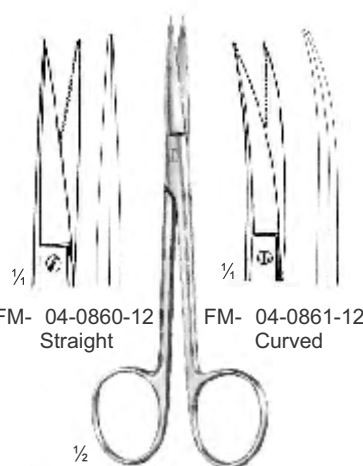

FM- 04-0859-12
 Curved

WAGNER
 12 cm/4 3/4"
 Saw edge

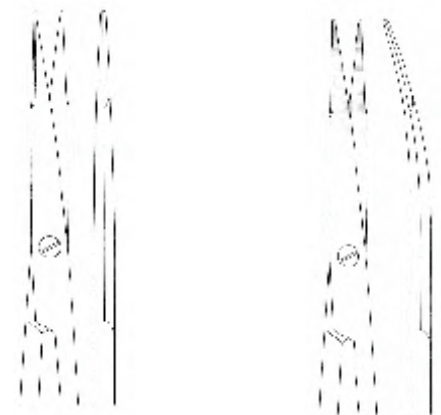

REYNOLDS

Straight		Curved
FM- 04-0862-14	14.5 cm/5 3/4"	FM- 04-0863-14
FM- 04-0862-15	15.5 cm/6 1/8"	FM- 04-0863-15
FM- 04-0862-17	17.5 cm/6 7/8"	FM- 04-0863-17
FM- 04-0862-18	18.0 cm/7 1/8"	FM- 04-0863-18





EN Vascular Scissors, Coronary Scissors
 DE Gefäßscheren, Koronarscheren
 ES Tijeras vasculares, Tijeras coronarias
 FR Ciseaux vasculaires, ciseaux coronaires
 IT Forbici vascolari, Forbici coronarie

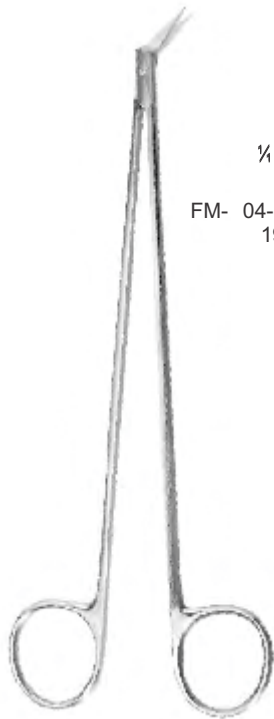

SCISSORS





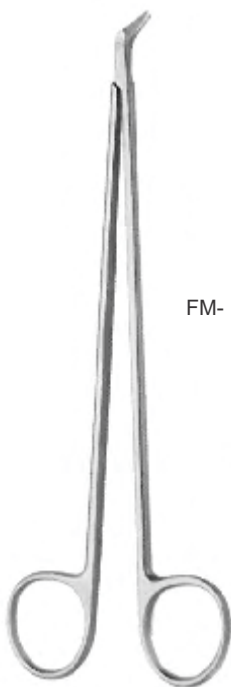

DIETHRICH

				
25° FM- 04-0868-19 19 cm/7 1/2"	45° FM- 04-0868-18 18 cm/7 1/8"	60° FM- 04-0868-17 17.5 cm/6 7/8"	90° FM- 04-0869-17 17.5 cm/6 7/8"	125° FM- 04-0870-17 17.5 cm/6 7/8"



MICRO-HEGEMANN
19 cm/7 1/2"

				
25° FM- 04-0871-19	45° FM- 04-0872-19	60° FM- 04-0873-19	90° FM- 04-0874-19	125° FM- 04-0875-19

Supercut Scissors **EN**
 Supercut Scheren **DE**
 Tijeras Supercut **ES**
 Ciseaux Supercut **FR**
 Forbici supercut **IT**

04



FAIZAN & MUSA
 SURGICAL INSTRUMENTS



STANDARD
 FM- 04-0901-14 14.5 cm/5 3/4"

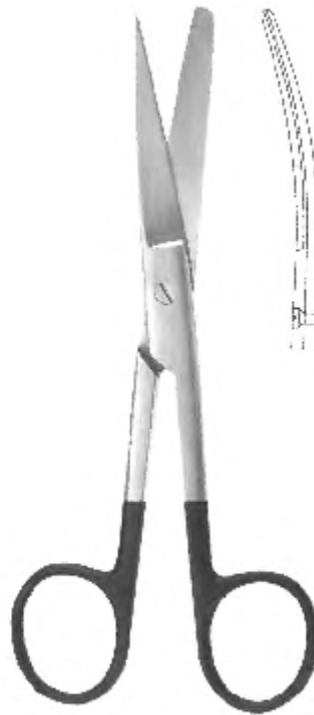

STANDARD
 FM- 04-0902-14 14.5 cm/5 3/4"

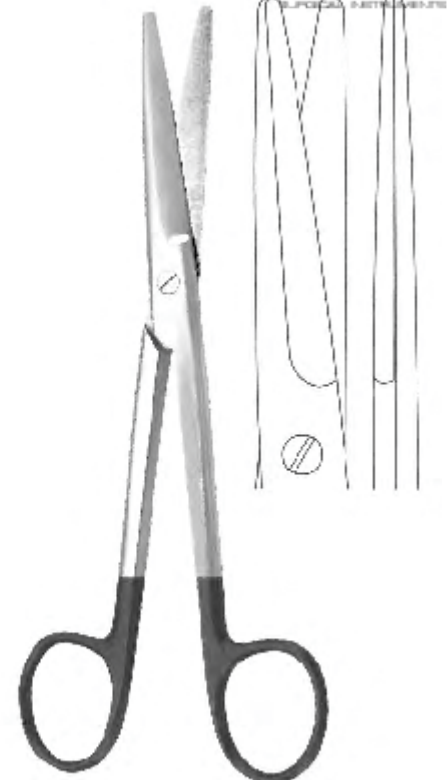

MAYO
 FM- 04-0903-14 14.5 cm/5 3/4"
 FM- 04-0903-17 17 cm/6 3/4"
 FM- 04-0903-23 23 cm/9"

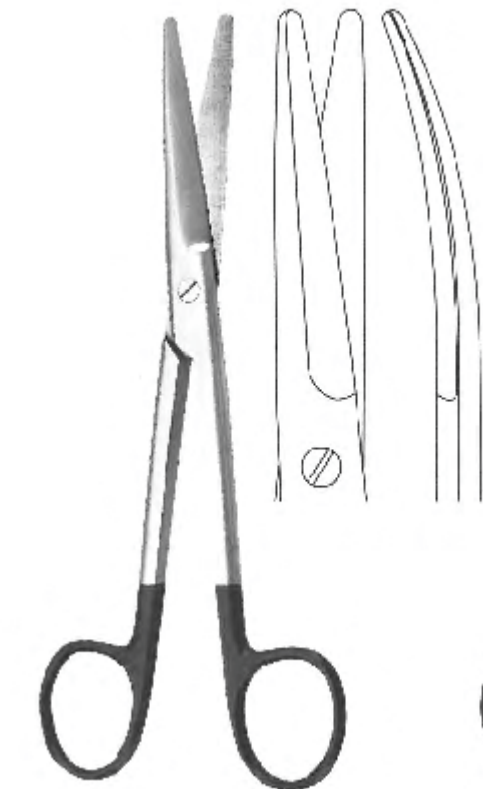

MAYO
 FM- 04-0904-14 14.5 cm/5 3/4"
 FM- 04-0904-17 17 cm/6 3/4"

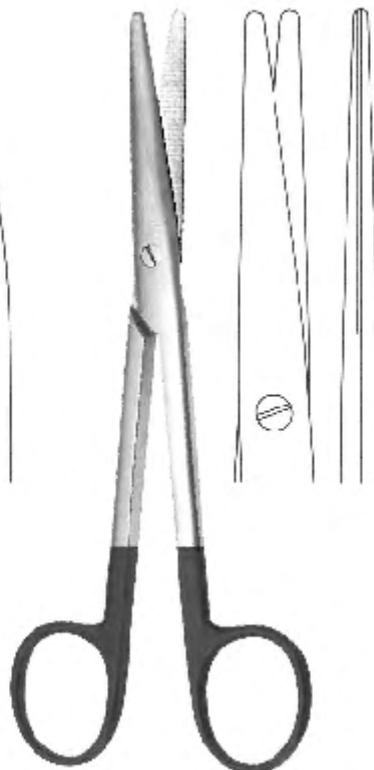

MAYO-STILLE
 FM- 04-0905-15 15 cm/5 7/8"
 FM- 04-0905-17 17 cm/6 3/4"

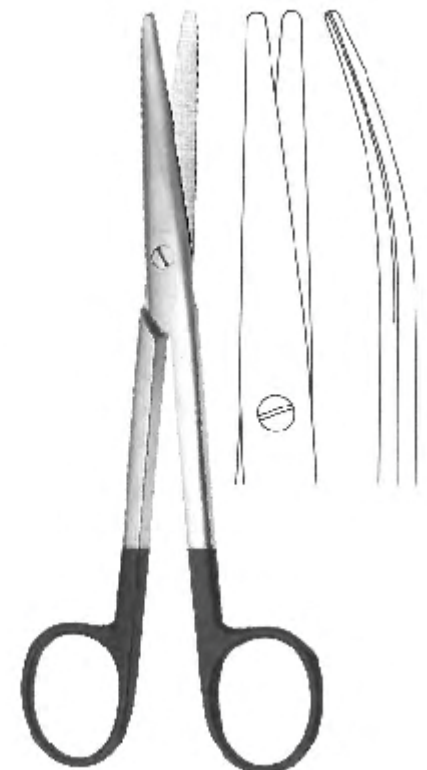

MAYO-STILLE
 FM- 04-0906-16 15 cm/5 7/8"
 FM- 04-0906-17 17 cm/6 3/4"

SUPERCUT SCISSORS

EN	Supercut Scissors
DE	Supercut Scheren
ES	Tijeras Supercut
FR	Ciseaux Supercut
IT	Forbici supercut



FAIZAN & MUSA
SURGICAL INSTRUMENTS

SUPERCUT SCISSORS

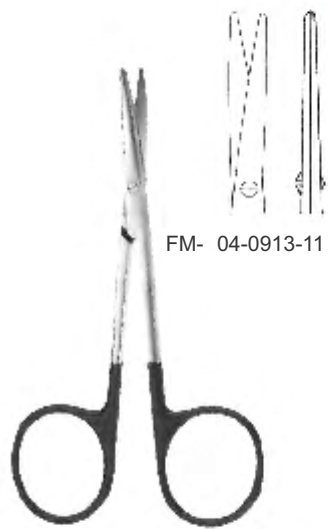

FM- 04-0913-11

STRABISMUS
11.5 cm/4 1/2"

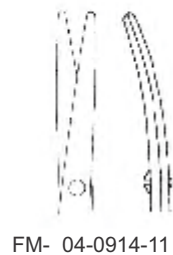

FM- 04-0914-11



FM- 04-0915-16

LEXER
16 cm/6 1/4"



FM- 04-0916-16



FM- 04-0917-14

METZENBAUM-FINO
14.5 cm/5 3/4"



FM- 04-0918-14

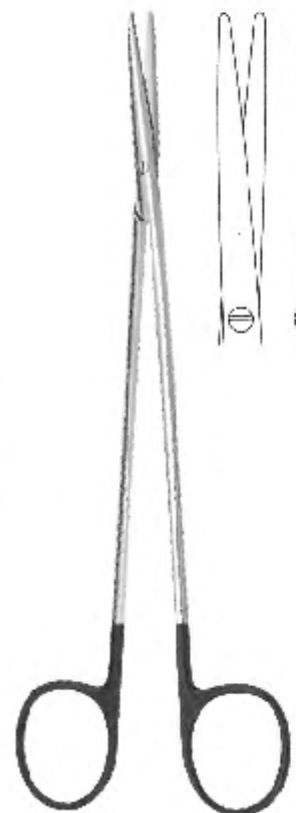

METZENBAUM-FINO
FM- 04-0919-18 18 cm/7 1/8"
FM- 04-0919-20 20 cm/7 7/8"
FM- 04-0919-23 23 cm/9"

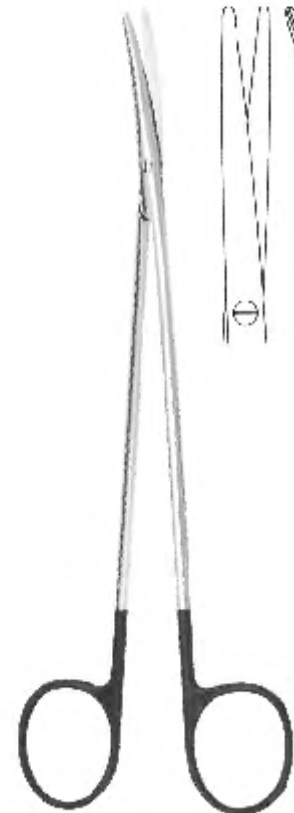

METZENBAUM-FINO
FM- 04-0920-18 18 cm/7 1/8"
FM- 04-0920-20 20 cm/7 7/8"
FM- 04-0920-23 23 cm/9"

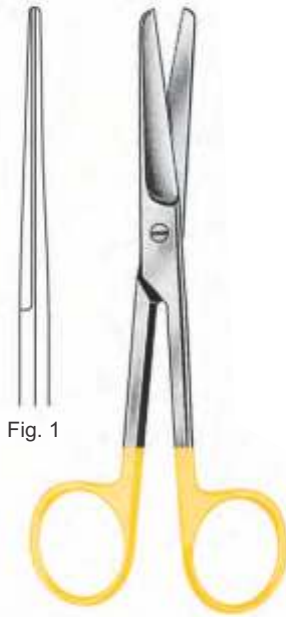

Fig. 1

STANDARD
FM- 04-1001-14
14.5 cm/5 3/4"



Fig. 2

STANDARD
FM- 04-1002-14
14.5 cm/5 3/4"



Fig. 3

STANDARD
FM- 04-1003-14
14.5 cm/5 3/4"

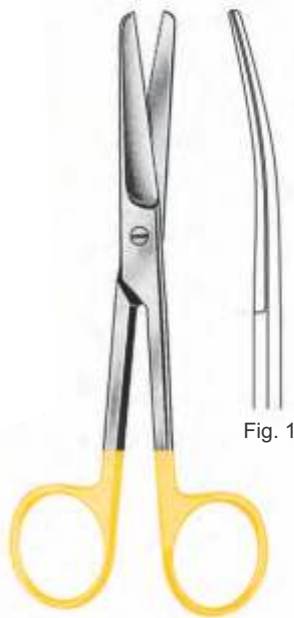

Fig. 1

STANDARD
FM- 04-1004-14
14.5 cm/5 3/4"



Fig. 2

STANDARD
FM- 04-1005-14
14.5 cm/5 3/4"



Fig. 3

STANDARD
FM- 04-1006-14
14.5 cm/5 3/4"

TC SCISSORS

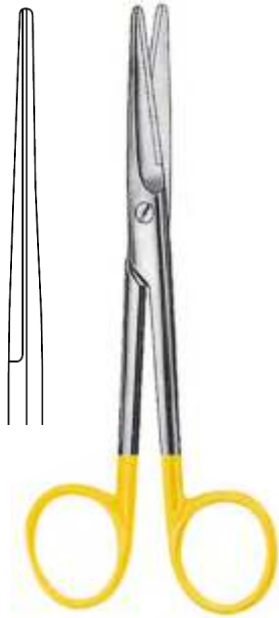

MAYO-Straight
 FM- 04-1007-14 14.5 cm/5 3/4"
 FM- 04-1007-17 17 cm/6 3/4"
 FM- 04-1007-23 23 cm/9"



MAYO-Curved
 FM- 04-1008-14 14.5 cm/5 3/4"
 FM- 04-1008-17 17 cm/6 3/4"
 FM- 04-1008-23 23 cm/9"

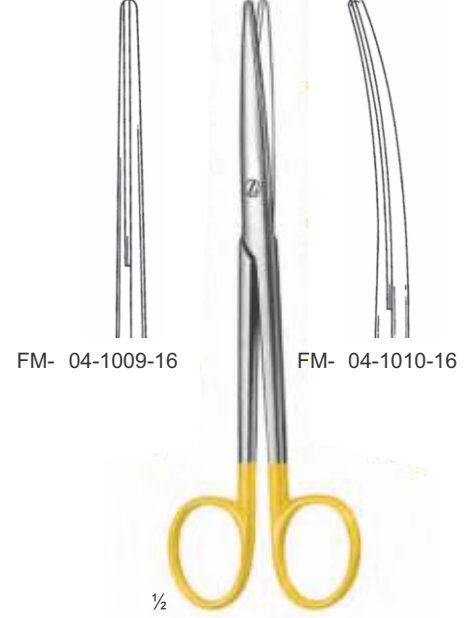

MAYO-LEXER
 Dissecting
 16 cm/6 1/4"

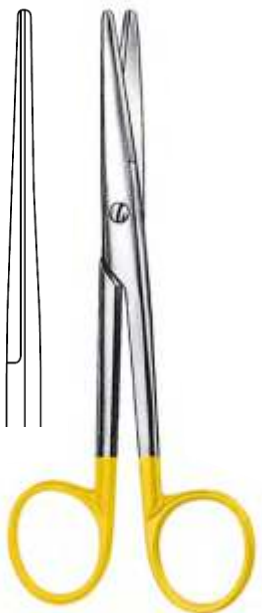

MAYO-STILLE
 FM- 04-1011-14 14.5 cm/5 3/4"
 FM- 04-1011-17 17 cm/6 3/4"

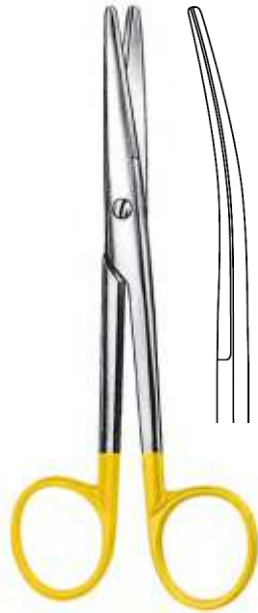

MAYO-STILLE
 FM- 04-1012-14 14.5 cm/5 3/4"
 FM- 04-1012-17 17 cm/6 3/4"

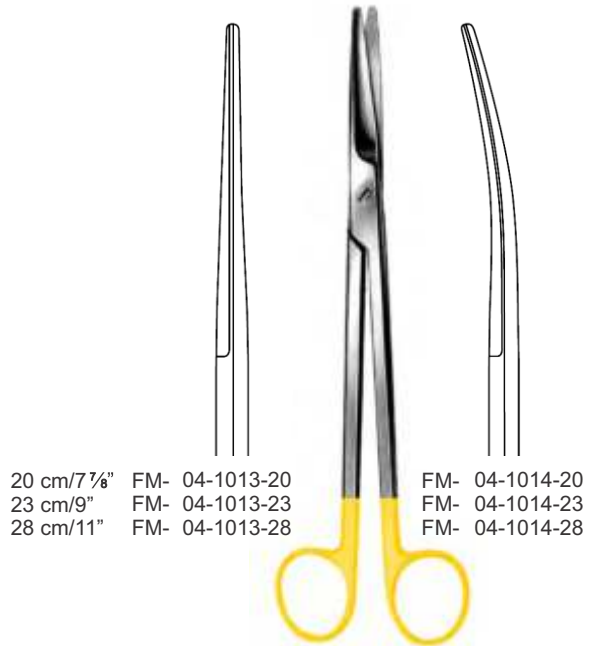

20 cm/7 7/8" FM- 04-1013-20
 23 cm/9" FM- 04-1013-23
 28 cm/11" FM- 04-1013-28
 FM- 04-1014-20
 FM- 04-1014-23
 FM- 04-1014-28

MAYO-HARRINGTON
 Gynecological

Dissecting Scissors EN

Präparierscheren DE

Tijeras para preparaciones ES

Ciseaux à disséquer FR

Forbici da dissezione IT

04



FAIZAN & MUSA
SPECIAL INSTRUMENTS

TC SCISSORS



MAYO-Straight

- FM- 04-1007-14 14.5 cm/5 3/4"
- FM- 04-1007-17 17 cm/6 3/4"
- FM- 04-1007-23 23 cm/9"

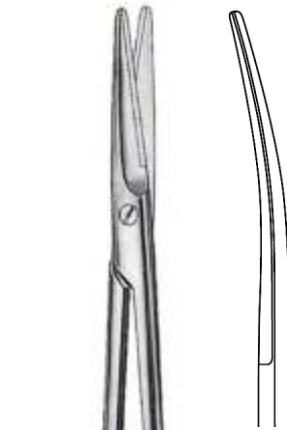

MAYO-Curved

- FM- 04-1008-14 14.5 cm/5 3/4"
- FM- 04-1008-17 17 cm/6 3/4"
- FM- 04-1008-23 23 cm/9"



FM- 04-1009-16

FM- 04-1010-16



1/2

MAYO-LEXER

Dissecting
16 cm/6 1/4"

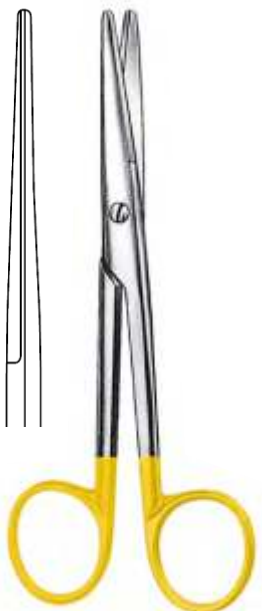

MAYO-STILLE

- FM- 04-1011-14 14.5 cm/5 3/4"
- FM- 04-1011-17 17 cm/6 3/4"

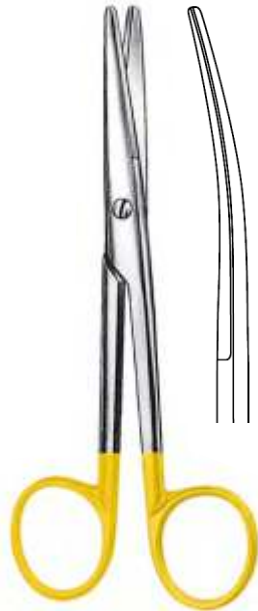

MAYO-STILLE

- FM- 04-1012-14 14.5 cm/5 3/4"
- FM- 04-1012-17 17 cm/6 3/4"

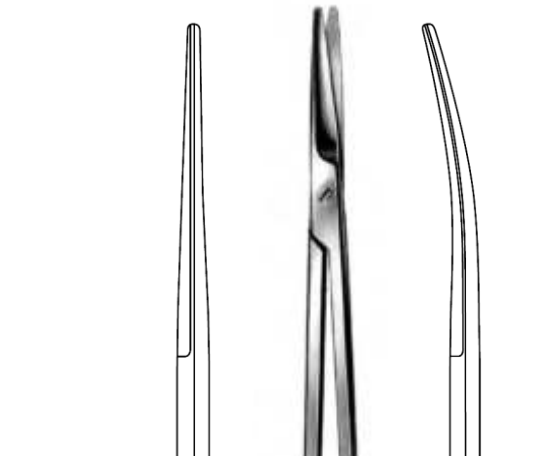

- 20 cm/7 7/8" FM- 04-1013-20
- 23 cm/9" FM- 04-1013-23
- 28 cm/11" FM- 04-1013-28

- FM- 04-1014-20
- FM- 04-1014-23
- FM- 04-1014-28

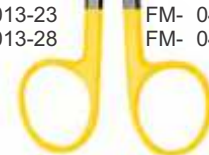

MAYO-HARRINGTON

Gynecological

TC SCISSORS

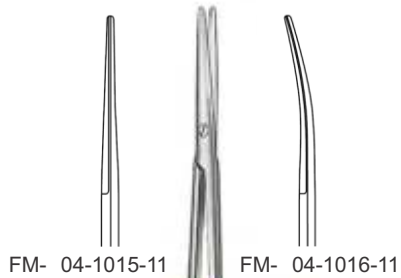

METZENBAUM
11.5 cm/4 1/2"

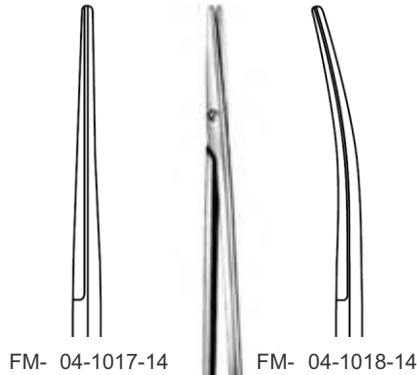

METZENBAUM
14.5 cm/5 3/4"



METZENBAUM

Straight		Curved
FM- 04-1019-18	18 cm/7 1/8"	FM- 04-1020-18
FM- 04-1019-20	20 cm/7 7/8"	FM- 04-1020-20
FM- 04-1019-23	23 cm/9"	FM- 04-1020-23
FM- 04-1019-25	25 cm/9 7/8"	FM- 04-1020-25
FM- 04-1019-28	28 cm/11"	FM- 04-1020-28
FM- 04-1019-30	30 cm/11 3/4"	FM- 04-1020-30



METZENBAUM-Fino
FM- 04-1021-14
14.5 cm/5 3/4"



METZENBAUM-Fino
FM- 04-1022-14
14.5 cm/5 3/4"



METZENBAUM-Fino
FM- 04-1023-14
14.5 cm/5 3/4"



METZENBAUM-Fino
FM- 04-1024-14
14.5 cm/5 3/4"

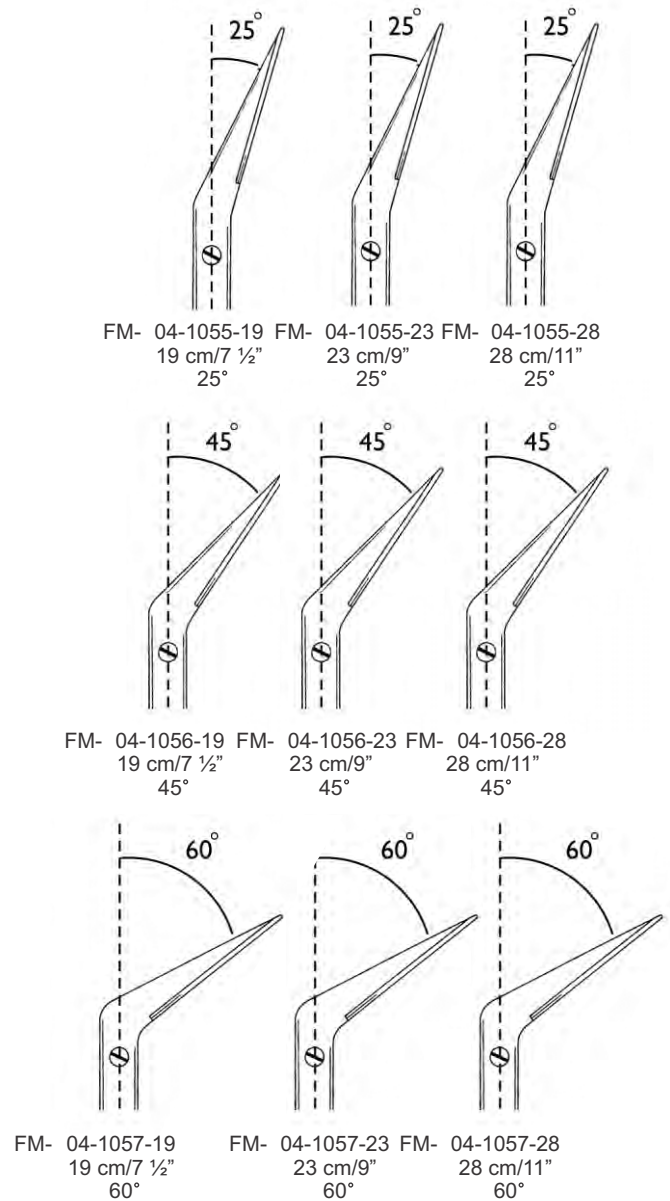
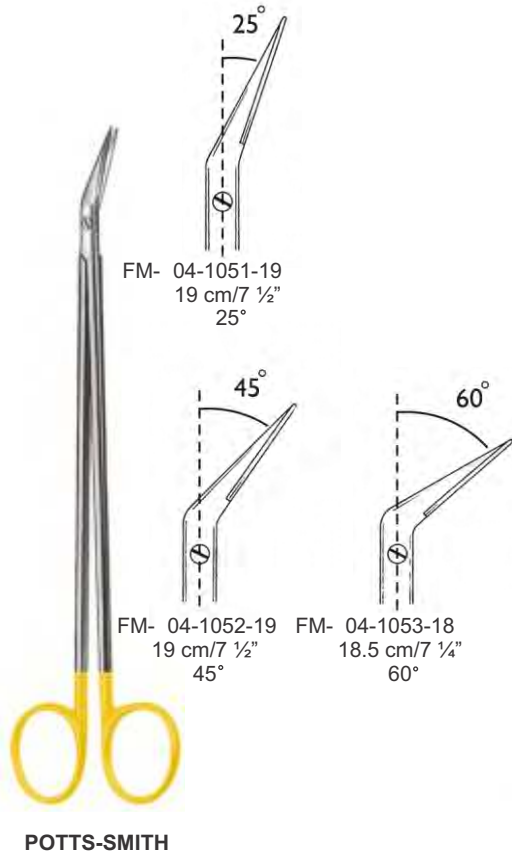

EN	Ligature Scissors
DE	Ligaturscheren
ES	Tijeras para ligaduras
FR	Ciseaux à ligatures
IT	Forbici per legature



For synthetic suture material
one toothed cutting edge



FM- 04-1101-14
14.5 cm/5 3/4"



FM- 04-1101-18
18 cm/7 1/8"



FM- 04-1101-20
20.5 cm/8 1/8"

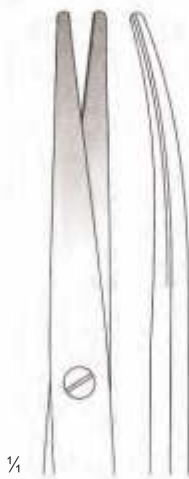

FM- 04-1101-23
23 cm/9"

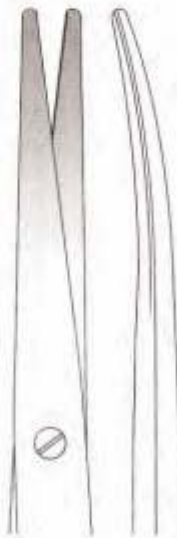

FM- 04-1101-25
25 cm/9 7/8"



FM- 04-1101-30
30 cm/11 3/4"



FAIZAN & MUSA
SPECIAL INSTRUMENTS

- EN** Forceps
- DE** Pinzetten
- ES** Pinzas
- FR** Forceps
- IT** Forcipe

Page 46 to 54



EN	Dissecting Forceps
DE	Anatomische Pinzetten
ES	Pinzas de diseccion
FR	Pinces à dissection
IT	Pinze per dissezione

FORCEPS



Standard



Standard



Narrow

FM- 05-1201-10	10.5cm	FM- 05-1202 10	10.5cm
FM- 05-1201-11	11.5cm	FM- 05-1202 11	11.5cm
FM- 05-1201-13	13.0cm	FM- 05-1202 13	13.0cm
FM- 05-1201-14	14.5cm	FM- 05-1202 14	14.5cm
FM- 05-1201-16	16.0cm	FM- 05-1202 16	16.0cm
FM- 05-1201-18	18.0cm	FM- 05-1202 18	18.0cm
FM- 05-1201-20	20.0cm	FM- 05-1202 20	20.0cm
FM- 05-1201-23	23.0cm	FM- 05-1202 23	23.0cm
FM- 05-1201-25	25.0cm	FM- 05-1202 25	25.0cm
FM- 05-1201-30	30.0cm	FM- 05-1202 30	30.0cm



USA Model



Standard



Narrow

FM- 05-1203-12	12.0cm	FM- 05-1204-12	12.0cm
FM- 05-1203-13	13.0cm	FM- 05-1204-13	13.0cm
FM- 05-1203-14	14.5cm	FM- 05-1204-14	14.5cm
FM- 05-1203-15	15.0cm	FM- 05-1204-15	15.0cm
FM- 05-1203-18	18.0cm	FM- 05-1204-18	18.0cm
FM- 05-1203-21	21.0cm	FM- 05-1204-21	21.0cm
FM- 05-1203-25	25.0cm	FM- 05-1204-25	25.0cm
FM- 05-1203-31	31.0cm		



Stille
FM- 05-1205-15
15.0cm



Ochsner
FM- 05-1206-14
14.0cm



Treves
Turn over
FM- 05-1207-12 12.0cm
FM- 05-1207-15 15.0cm
FM- 05-1207-18 18.0cm
FM- 05-1207-20 20.0cm
FM- 05-1207-25 25.0cm



Treves
Block end
FM- 05-1208-12 12.0cm
FM- 05-1208-15 15.0cm
FM- 05-1208-18 18.0cm
FM- 05-1208-20 20.0cm
FM- 05-1208-25 25.0cm





Cushing

FM- 05-1209-17 17.0cm FM- 05-1210-17



Potts Smith

FM- 05-1211-18 18.0cm
 FM- 05-1211-21 21.0cm
 FM- 05-1211-25 25.0cm
 FM- 05-1211-30 30.0cm



Waugh

FM- 05-1212-15 15.0cm FM- 05-1213-20 20.0cm
 FM- 05-1212-18 18.0cm
 FM- 05-1212-20 20.0cm



Brophy

FM- 05-1214-20

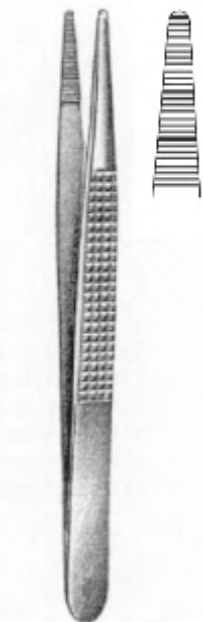

Bonney

FM- 05-1215-17
 17.5cm



Ramsey

FM- 05-1216-18
 18.0cm



Duehrssen

FM- 05-1217-20
 20.0cm



Wangensteen

FM- 05-1218-23
 23.0cm

EN	Dissecting Forceps
DE	Anatomische Pinzetten
ES	Pinzas de diseccion
FR	Pinces à dissection
IT	Pinze per dissezione

FORCEPS



Adson
 FM- 05-1219-12 12.0cm
 FM- 05-1219-15 15.0cm
 FM- 05-1219-18 18.0cm



McIndoe
 FM- 05-1220-15 15.0cm



Semken
 FM- 05-1221-12 12.0cm FM- 05-1222-12
 FM- 05-1221-15 15.0cm FM- 05-1222-15



Gerald
 FM- 05-1223-18 18.0cm



Gerald
 FM- 05-1224-18 18.0cm



Gerald
 FM- 05-1225-18 18.0cm



Taylor
 FM- 05-1226-17 17.5cm Str
 FM- 05-1227-17 17.5cm Cvd



Taylor
 FM- 05-1228-17
 18.5cm



Taylor
 FM- 05-1229-17
 17.5cm



Jefferson
 FM- 05-1230-18
 18.0cm,180mm



Adson
 FM- 05-1231-18
 18.0cm,180mm

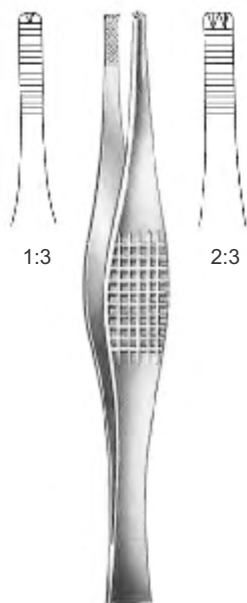

Ferris-Smith
 FM- 05-1232-18 18.0cm FM- 05-1233-18

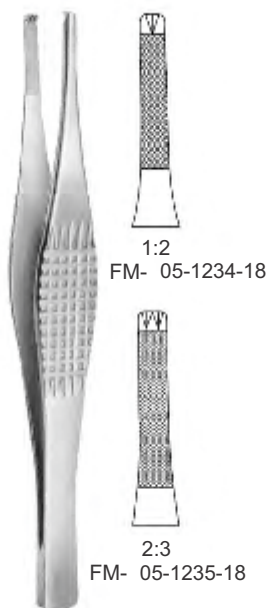

Ramsay
 18.0cm

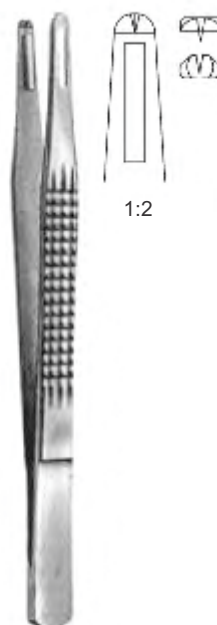

Charnley
 FM- 05-1236-18 18.0cm



Jeans
 FM- 05-1237-14 14.5cm
 FM- 05-1237-17 17.5cm

EN	Tissue Forceps
DE	Chirurgische Pinzetten
ES	Pinzas de diseccion con dientes
FR	Pinces à dissection à griffes
IT	Pinze per dissezione con denti

FORCEPS



Adson
FM- 05-1260-18 18.0cm

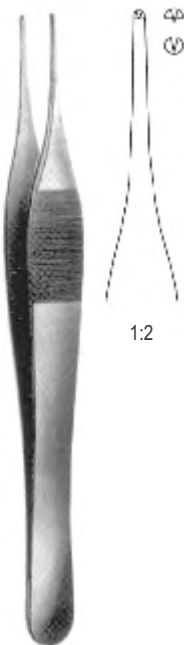

Jefferson
FM- 05-1261-18 18.0cm



Lanes
FM- 05-1262-12 12.5cm
FM- 05-1262-15 15.0cm
FM- 05-1262-18 18.0cm
FM- 05-1262-20 20.0cm

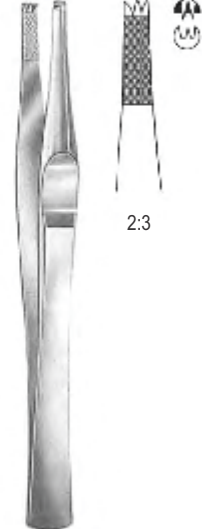

Lanes
FM- 05-1263-12 12.5cm
FM- 05-1263-15 15.5cm
FM- 05-1263-18 18.0cm
FM- 05-1263-20 20.0cm

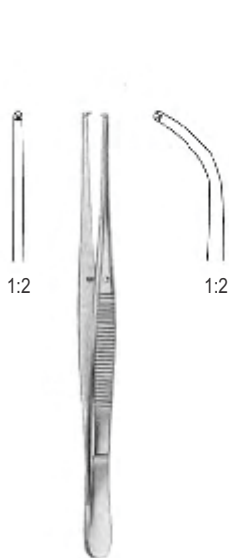

Semken
FM- 05-1264-12 12.5cm FM- 05-1265-12
FM- 05-1264-15 15.0cm FM- 05-1265-15

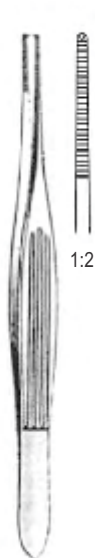

McIndoe
FM- 05-1266-15 15.0cm

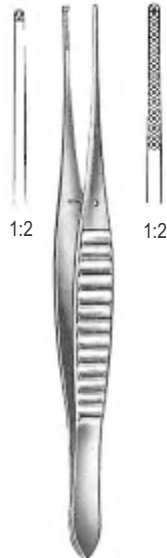

Gillies
FM- 05-1267-15 Plain FM- 05-1267-15S Serrated
FM- 05-1267-15S Serrated 15.0cm



Waugh
FM- 05-1268-15 15.0cm FM- 05-1268-18 18.0cm
FM- 05-1268-20 20.0cm



Potts Smith
FM- 05-1269-18 18.0cm FM- 05-1269-21 21.0cm
FM- 05-1269-25 25.0cm FM- 05-1269-30 30.0cm

Tissue Forceps EN

Chirurgische Pinzetten DE

Pinzas de diseccion con dientes ES

Pinces à dissection à griffes FR

Pinze per dissezione con denti IT

05

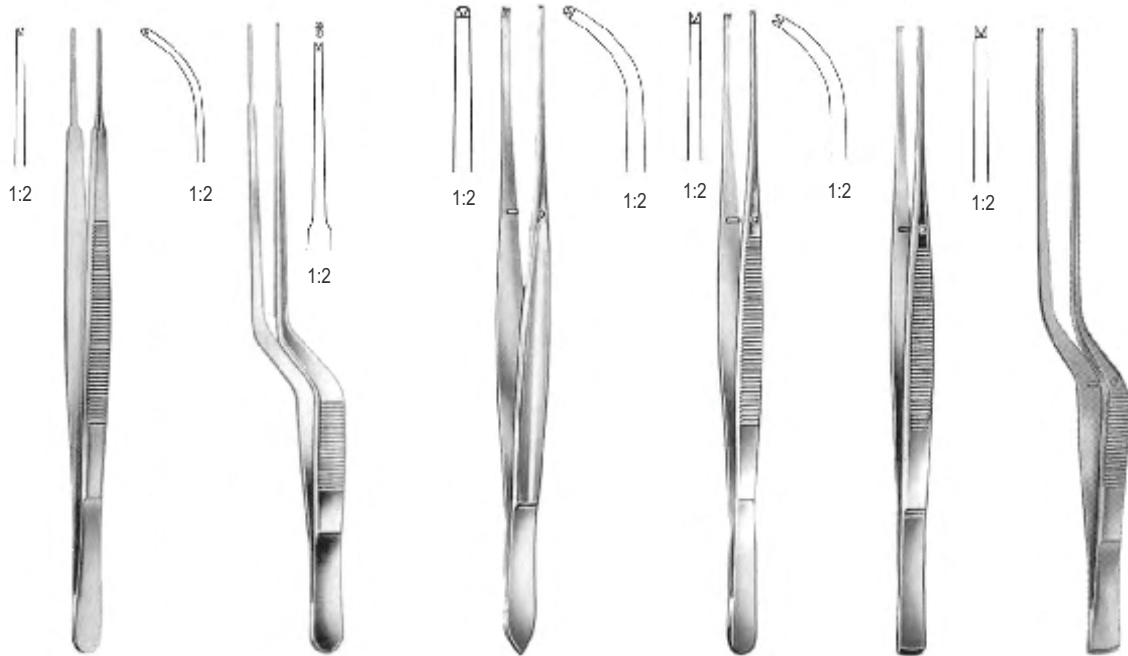

Gerald

FM- 05-1270-01 18.0cm
FM- 05-1270-02 18.0cm

Gerald

FM- 05-1271-18 18.0cm

Cushing

FM- 05-1272-01 17.5cm
FM- 05-1272-02 17.5cm

Taylor

FM- 05-1273-01 17.5cm
FM- 05-1273-02 17.5cm

Taylor

FM- 05-1274-17 17.5cm

Taylor

FM- 05-1275-17 17.5cm

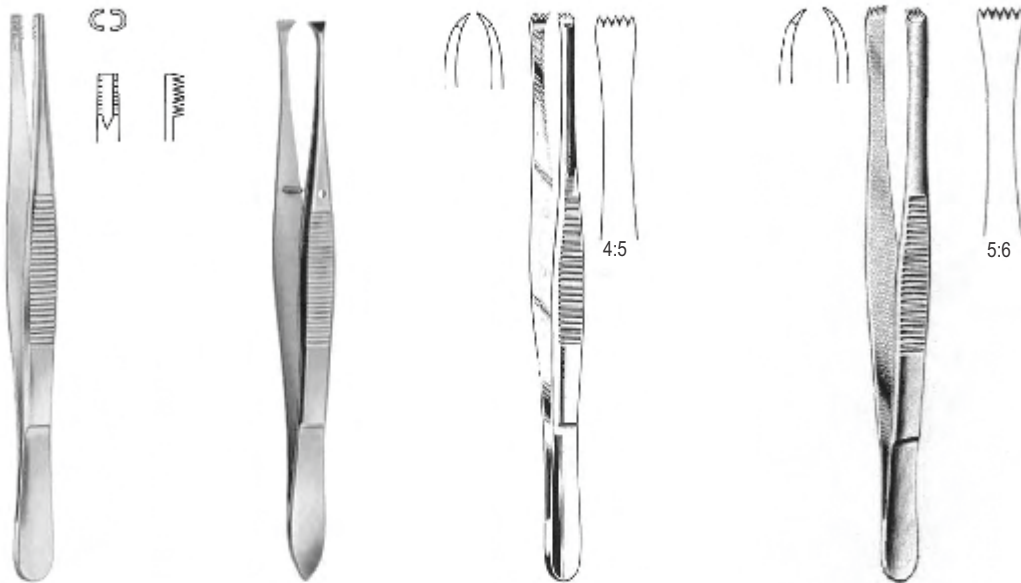

Brown

FM- 05-1276-15 15.0cm
FM- 05-1276-20 20.0cm
FM- 05-1276-25 25.0cm

Graefe

FM- 05-1277-10 10.0cm

Stone

FM- 05-1278-15 15.0cm

Lerche

FM- 05-1279-15 15.0cm

EN Splinter Forceps

DE Spitter-Pinzetten

ES Pinzas para espinas

FR Pincés à échardes

IT Pinze per scheggie



Peet
FM- 05-1326-11 11.5cm

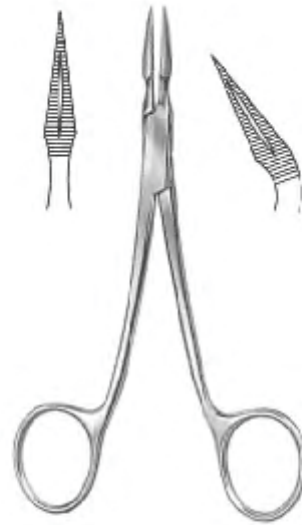

Arther
FM- 05-1327-14 14.0cm 05-1327-14A

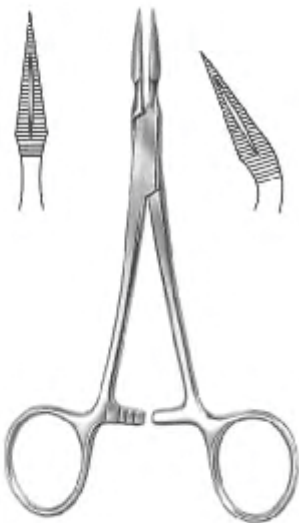

Stieglitz
FM- 05-1328-13 13.5cm 05-1329-13

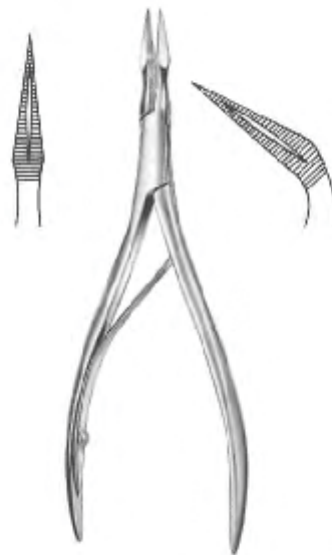

Ralk
FM- 05-1330-15 15.0cm 05-1331-15

Dissecting Forceps	EN
Anatomische Pinzetten	DE
Pinzas de diseccion	ES
Pinces à dissection	FR
Pinze per dissezione	IT

05



FAIZAN & MUSA
SPECIAL INSTRUMENTS

TC GOLD

FORCEPS



Standard

- FM- 05-1332-14 14.5cm/5 3/4"
- FM- 05-1332-16 16cm/6 1/4"
- FM- 05-1332-18 18cm/7"
- FM- 05-1332-20 20cm/8"
- FM- 05-1332-25 25cm/10"



Adson

- FM- 05-1333-12 12cm/4 3/4"
- FM- 05-1333-15 15.5cm/6"



McIndoe

- FM- 05-1334-15 15cm/6"



Semken

- FM- 05-1335-12 12cm/4 3/4"
- FM- 05-1335-15 15cm/6"



- FM- 05-1336-18 18cm/7"



Cushing

- FM- 05-1337-18 18cm/7"



Cushing-Taylor

- FM- 05-1338-18 18cm/7"



Grunwald

- FM- 05-1339-18 18cm/7"

EN	Grasping Forceps
DE	Faßpinzetten
ES	Pinzas para coger
FR	Forceps Grasping
IT	Pinze

TC GOLD

FORCEPS



Wangensteen
FM- 05-1340-15 15cm/6"
FM- 05-1340-23 13cm/9"
FM- 05-1340-25 25cm/10"



FM- 05-1341-15 15cm/6"
FM- 05-1341-18 18cm/7"
FM- 05-1341-20 20cm/8"
FM- 05-1341-23 23cm/9"
FM- 05-1341-25 25cm/10"



Oehler
1:2
FM- 05-1342-14 14.5cm/5 1/2"
FM- 05-1342-16 16cm/6 1/4"
FM- 05-1342-18 18cm/7"
FM- 05-1342-20 20cm/8"
FM- 05-1342-25 25cm/10"
FM- 05-1342-30 30cm/12"



Micro-Adson
FM- 05-1343-12 12cm/4 3/4"
FM- 05-1343-15 15.5cm/6"



Standard-Adson
FM- 05-1344-12 12cm/4 3/4"
FM- 05-1344-15 15.5cm/6"



Adson-Brown
FM- 05-1345-12 12cm/4 3/4"



Gillies
FM- 05-1346-15 15 cm/6"

EN	Artery Forceps	Page 55 to 70
DE	Arterienklemmen	
ES	Pinzas hemostáticas	
FR	Forceps de l'artère	
IT	Arteria Forcipe	



EN	Haemostatic Forceps
DE	Arterienklemmen
ES	Pinzas hemostáticas
FR	Pinces hémostatiques
IT	Pinza emostatica

ARTERY FORCEPS



HALSTED-MOSQUITO

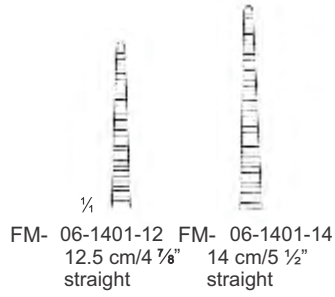

FM- 06-1401-12 12.5 cm/4 7/8" straight
 FM- 06-1401-14 14 cm/5 1/2" straight

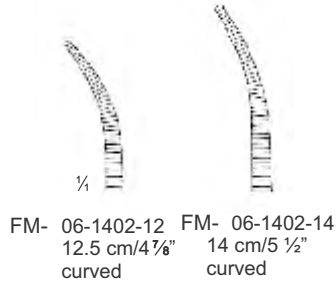

FM- 06-1402-12 12.5 cm/4 7/8" curved
 FM- 06-1402-14 14 cm/5 1/2" curved



HALSTED-MOSQUITO

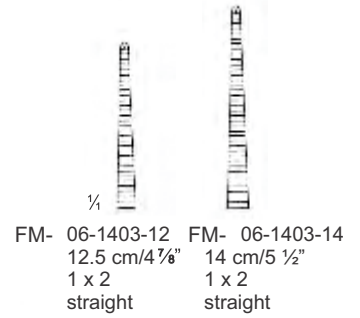

FM- 06-1403-12 12.5 cm/4 7/8" 1 x 2 straight
 FM- 06-1403-14 14 cm/5 1/2" 1 x 2 straight

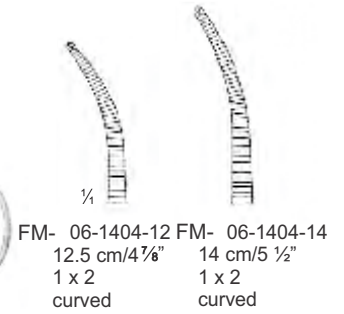

FM- 06-1404-12 12.5 cm/4 7/8" 1 x 2 curved
 FM- 06-1404-14 14 cm/5 1/2" 1 x 2 curved

ATRAUMA

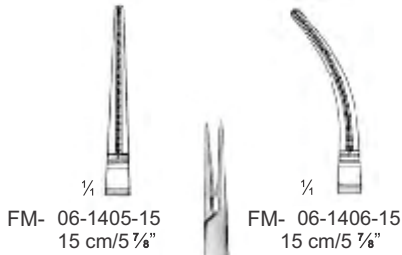

FM- 06-1405-15 15 cm/5 7/8"
 FM- 06-1406-15 15 cm/5 7/8"

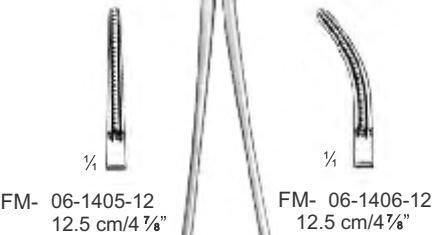

FM- 06-1405-12 12.5 cm/4 7/8"
 FM- 06-1406-12 12.5 cm/4 7/8"

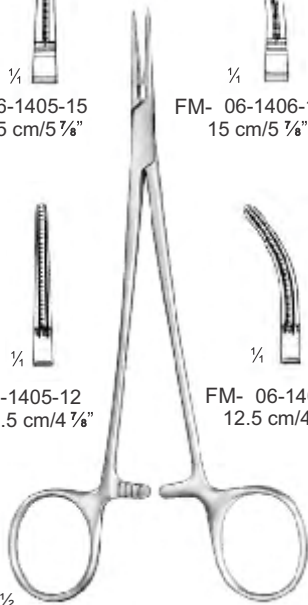

DEBAKEY-MOSQUITO

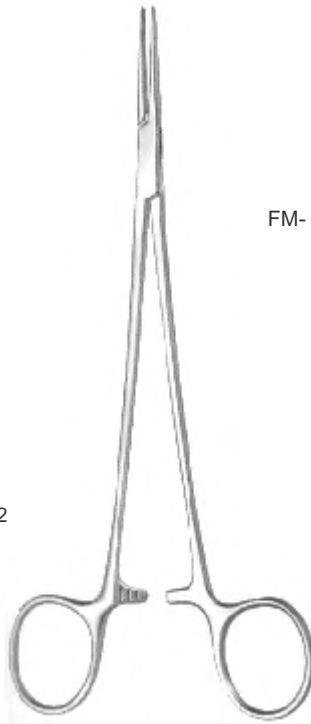

HALSTED-MOSQUITO

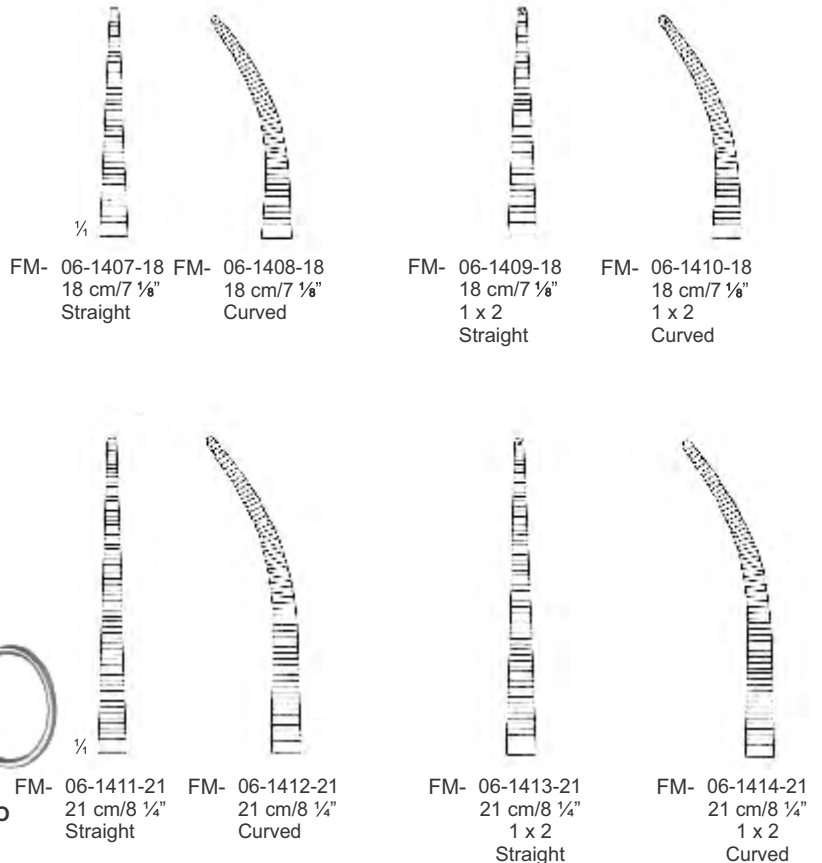

FM- 06-1407-18 18 cm/7 1/8" Straight
 FM- 06-1408-18 18 cm/7 1/8" Curved
 FM- 06-1409-18 18 cm/7 1/8" 1 x 2 Straight
 FM- 06-1410-18 18 cm/7 1/8" 1 x 2 Curved
 FM- 06-1411-21 21 cm/8 1/4" Straight
 FM- 06-1412-21 21 cm/8 1/4" Curved
 FM- 06-1413-21 21 cm/8 1/4" 1 x 2 Straight
 FM- 06-1414-21 21 cm/8 1/4" 1 x 2 Curved

Haemostatic Forceps **EN**
 Arterienklemmen **DE**
 Pinzas hemostáticas **ES**
 Pincas hémostatiques **FR**
 Pinza emostatica **IT**

06



ARTERY FORCEPS

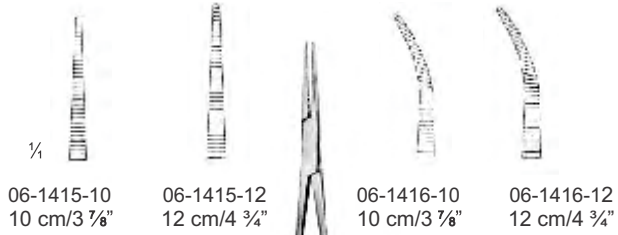

06-1415-10 10 cm/3 7/8" $\frac{1}{4}$
 06-1415-12 12 cm/4 3/4"
 06-1416-10 10 cm/3 7/8"
 06-1416-12 12 cm/4 3/4"

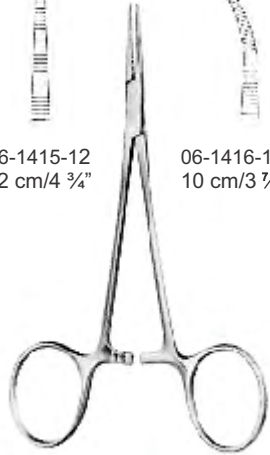

MICRO-MOSQUITO

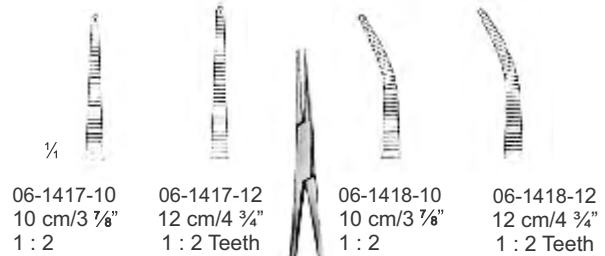

06-1417-10 10 cm/3 7/8" $\frac{1}{4}$
 06-1417-12 12 cm/4 3/4" 1 : 2 Teeth
 06-1418-10 10 cm/3 7/8" 1 : 2
 06-1418-12 12 cm/4 3/4" 1 : 2 Teeth

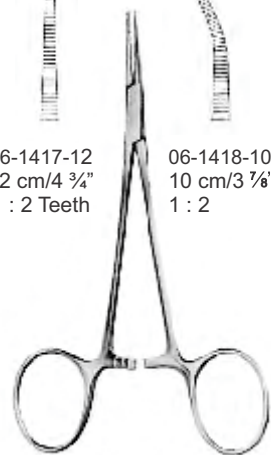

MICRO-MOSQUITO

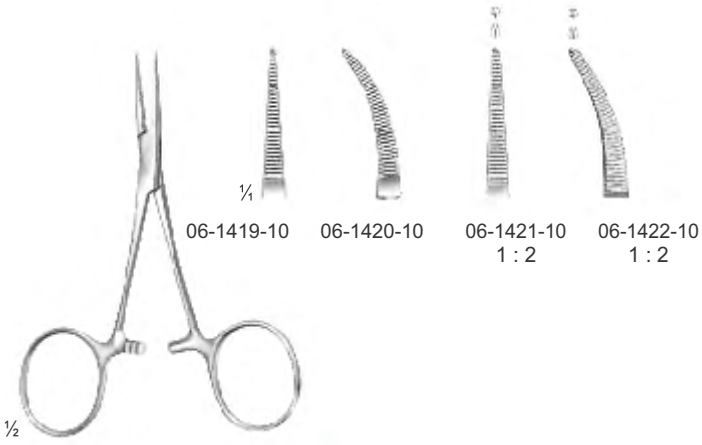

06-1419-10 $\frac{1}{2}$
 06-1420-10
 06-1421-10 1 : 2
 06-1422-10 1 : 2

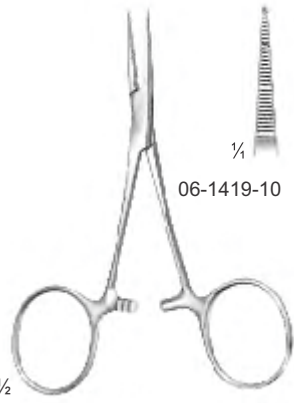

HARTMANN (BABY-MOSQUITO)
 10 cm/3 7/8"



CARREL
 FM- 06-1423-08
 8.5 cm/3 3/8"

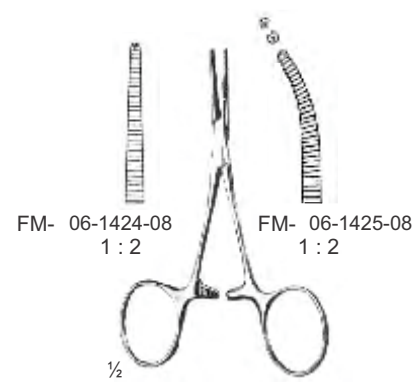

FM- 06-1424-08 1 : 2
 FM- 06-1425-08 1 : 2

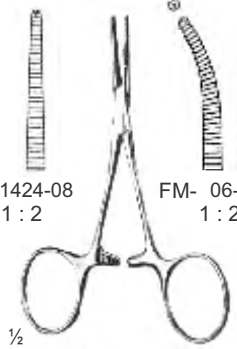

TERRIER
 8.5 cm/3 3/8"

EN	Haemostatic Forceps
DE	Arterienklemmen
ES	Pinzas hemostáticas
FR	Pinces hémostatiques
IT	Pinza emostatica

ARTERY FORCEPS

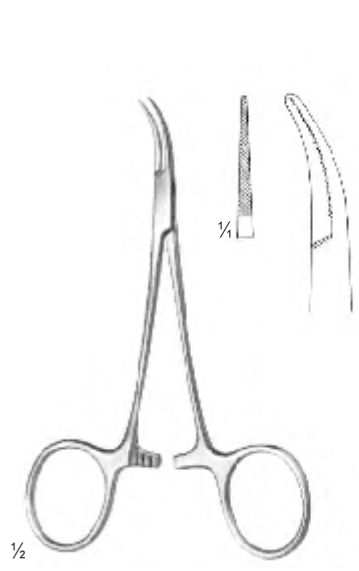

MOSQUITO-DANDY
06-1426-12
12 cm/4 3/4"

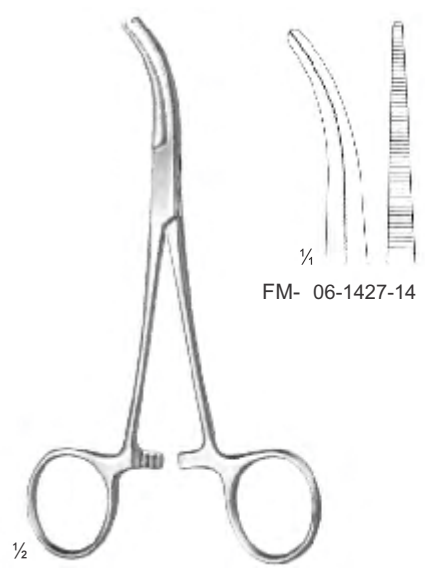

DANDY
14 cm/5 1/2"

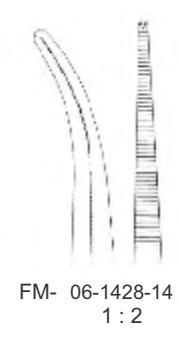

FM- 06-1427-14

FM- 06-1428-14
1 : 2

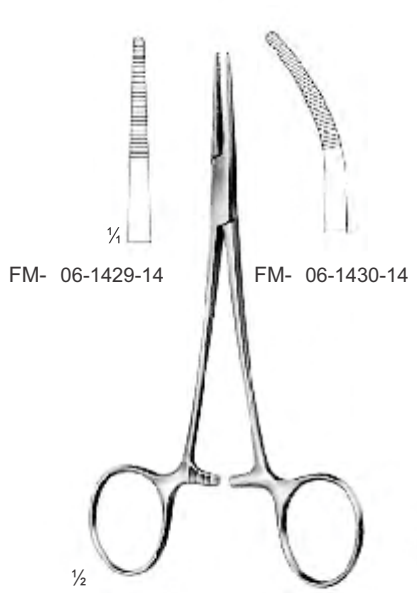

PROVIDENCE-HOSPITAL
14 cm/5 1/2"

FM- 06-1429-14

FM- 06-1430-14

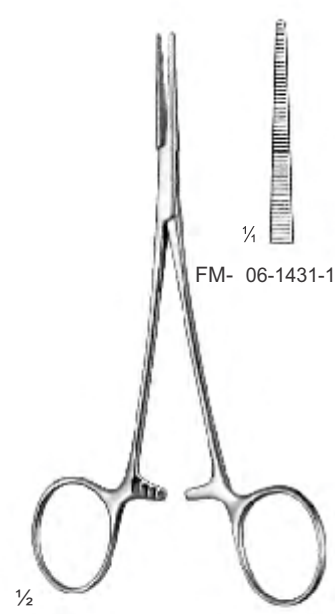

LERICHE
15 cm/5 7/8"

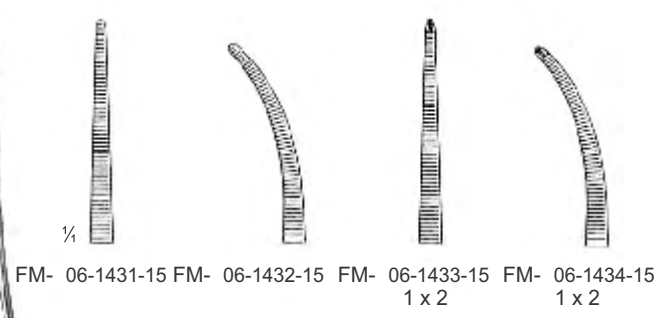

FM- 06-1431-15

FM- 06-1432-15

FM- 06-1433-15
1 x 2

FM- 06-1434-15
1 x 2

Haemostatic Forceps **EN**
 Arterienklemmen **DE**
 Pinzas hemostáticas **ES**
 Pincers hémostatiques **FR**
 Pinza emostatica **IT**

06



FAIZAN & MUSA
 SPECIAL INSTRUMENTS

ARTERY FORCEPS

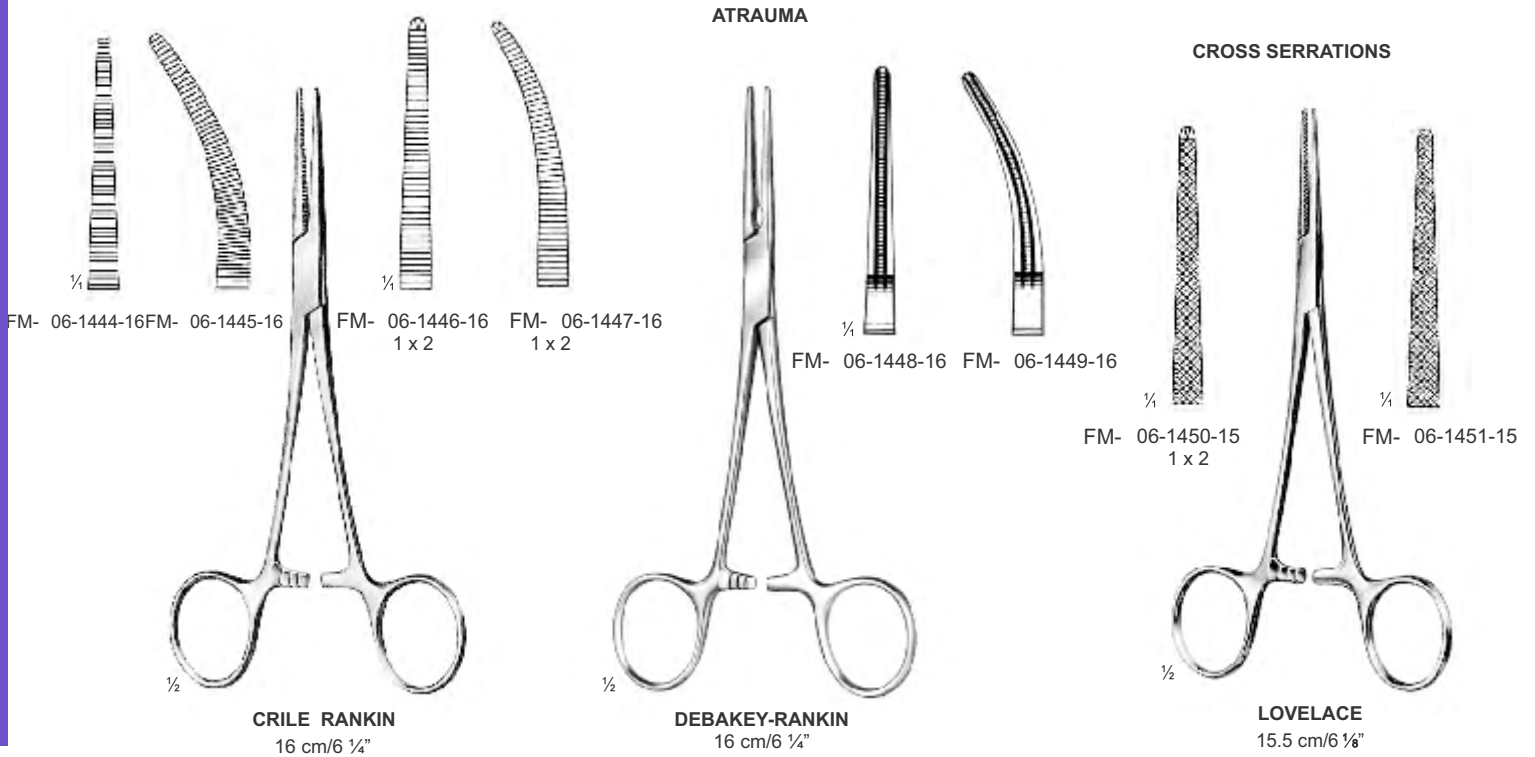
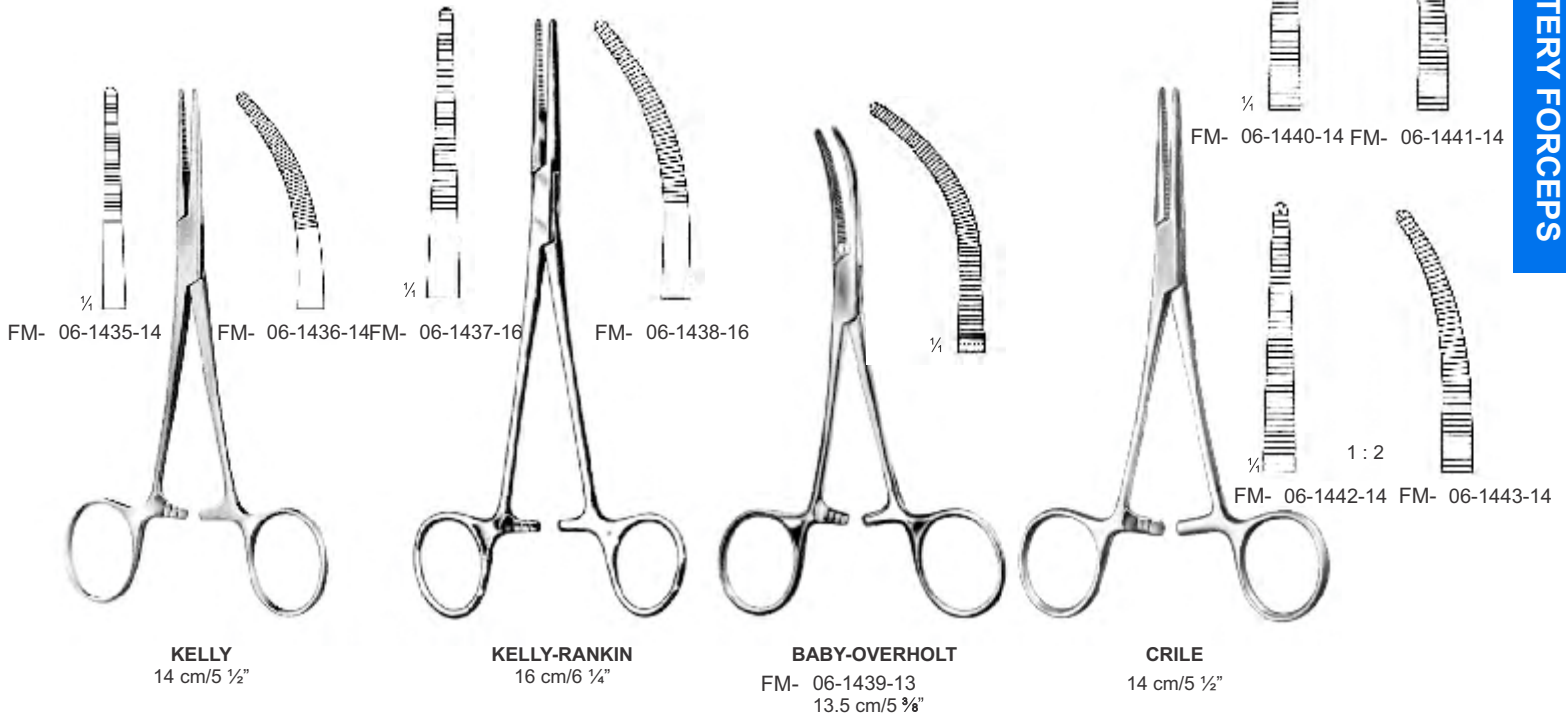

- EN Haemostatic Forceps
- DE Arterienklemmen
- ES Pinzas hemostáticas
- FR Pincès hémostatiques
- IT Pinza emostatica



ARTERY FORCEPS



SPENCER-WELLS/JONES



FM- 06-1452-13
13 cm/5 1/8"



FM- 06-1452-14
14.5 cm/5 3/4"

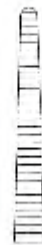

FM- 06-1452-15
15.5 cm/6 1/8"



FM- 06-1452-18
18.5 cm/7 1/4"



FM- 06-1452-20
20 cm/7 7/8"



FM- 06-1453-13
13 cm/5 1/8"



FM- 06-1453-14
14 cm/5 1/2"



FM- 06-1453-15
15 cm/5 7/8"



FM- 06-1453-18
18 cm/7 1/8"



FM- 06-1453-20
20 cm/7 7/8"



FM- 06-1454-13
13.5 cm/5 3/8"



FM- 06-1454-14
14.5 cm/5 3/4"

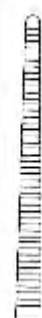

FM- 06-1454-17
17 cm/6 3/4"

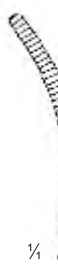

FM- 06-1455-13
13 cm/5 1/8"

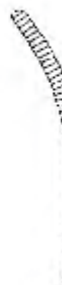

FM- 06-1455-14
14 cm/5 1/2"



FM- 06-1455-16
16.5 cm/6 1/2"

Cm	In	FM-
18	7 1/8"	FM- 06-1457-18
20	7 7/8"	FM- 06-1457-20
22	8 1/2"	FM- 06-1457-22
24	9 1/2"	FM- 06-1457-24
26	10 1/4"	FM- 06-1457-26
28	11"	FM- 06-1457-28



Straight



Curved



FM- 06-1459-18
1 x 2

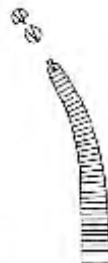

FM- 06-1460-18
1 x 2

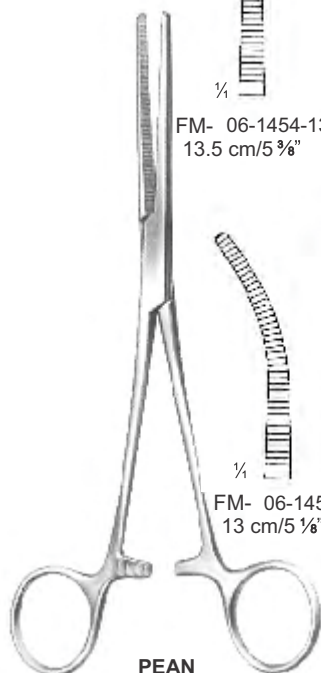

PEAN
DELICATE PATTERN

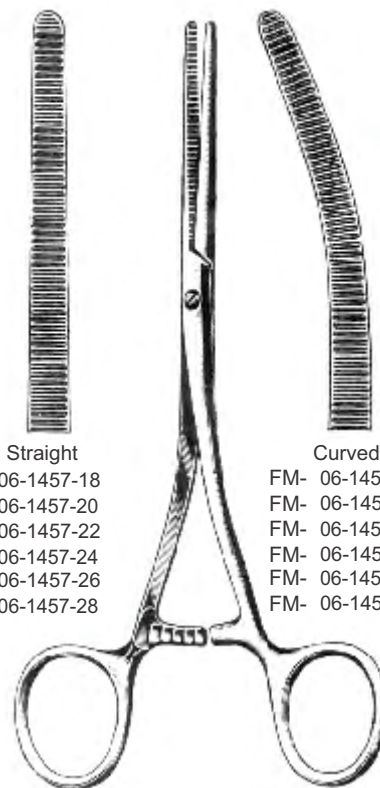

PEAN

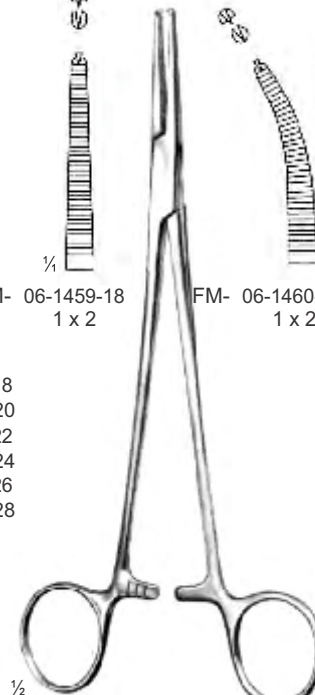

ADSON
18.5 cm/7 1/4"

Haemostatic Forceps **EN**
 Arterienklemmen **DE**
 Pinzas hemostáticas **ES**
 Pincas hémostatiques **FR**
 Pinza emostatica

06



FAIZAN & MUSA
 SPECIAL INSTRUMENTS

ARTERY FORCEPS

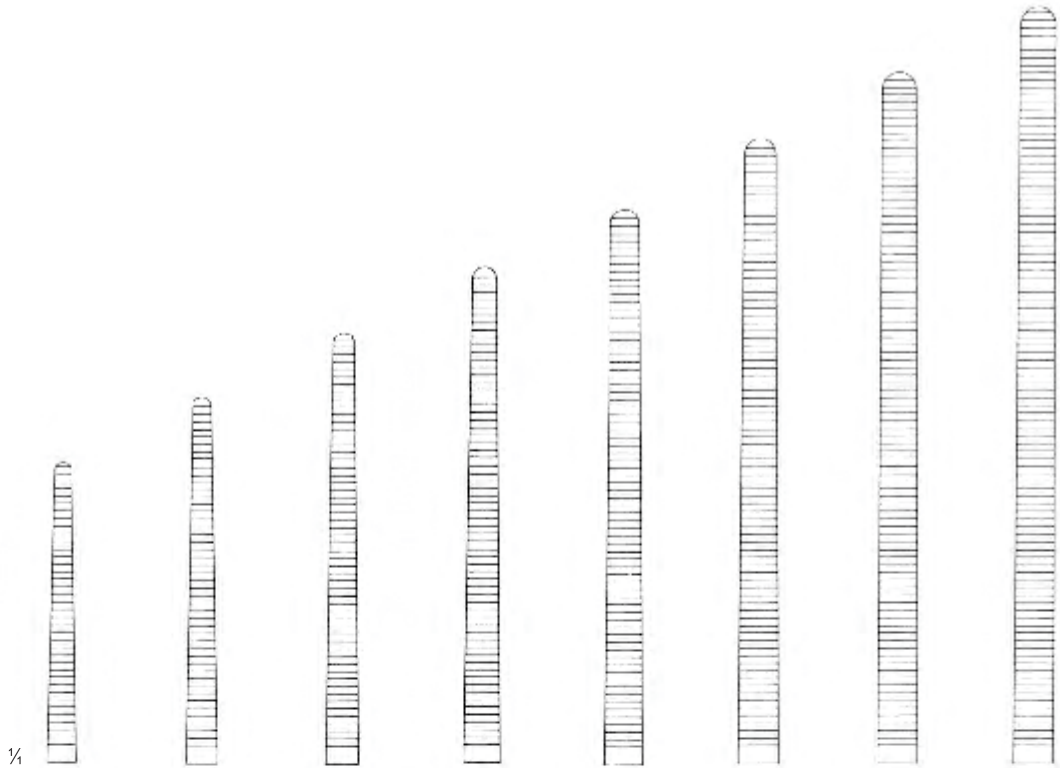

FM- 06-1461-14 FM- 06-1461-16 FM- 06-1461-18 FM- 06-1461-20 FM- 06-1461-22 FM- 06-1461-24 FM- 06-1461-26 FM- 06-1461-30
 14.5 cm/5 3/4" 16.5 cm/6 1/2" 18.5 cm/7 1/4" 20.5 cm/8 1/8" 22.5 cm/8 3/4" 24.5 cm/9 5/8" 26 cm/10 1/4" 30.5 cm/12"



ROCHESTER-PEAN

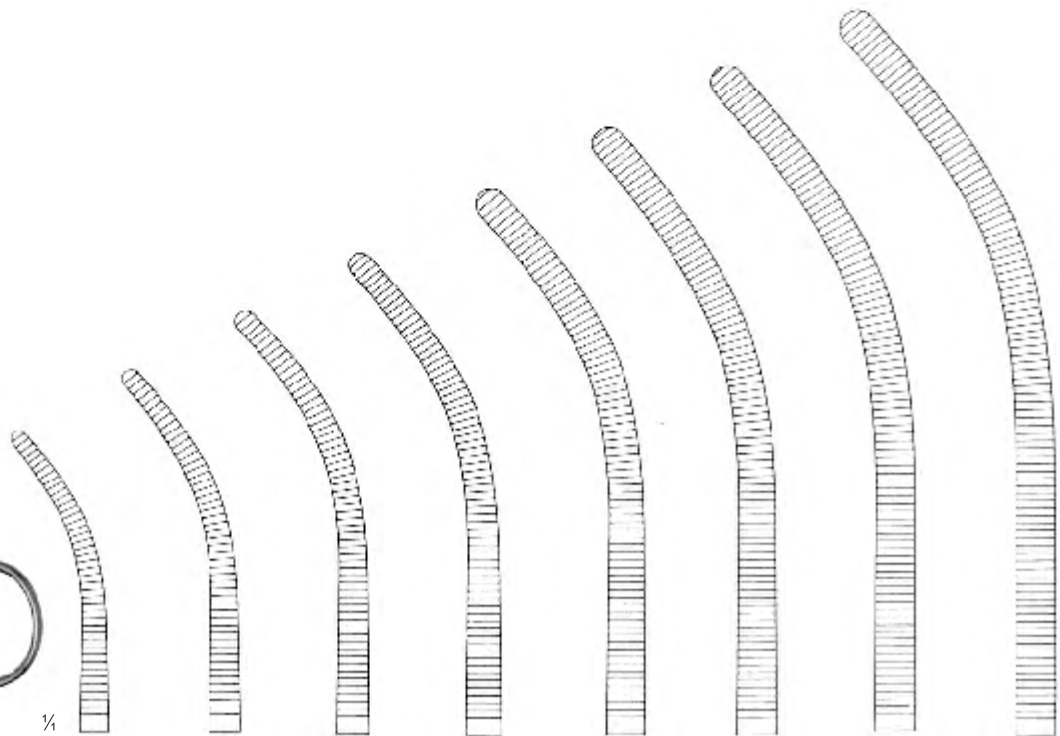

FM- 06-1462-14 FM- 06-1462-16 FM- 06-1462-18 FM- 06-1462-20 FM- 06-1462-22 FM- 06-1462-24 FM- 06-1462-26 FM- 06-1462-30
 14.5 cm/5 3/4" 16.5 cm/6 1/2" 18.5 cm/7 1/4" 20.5 cm/8 1/8" 22.5 cm/8 3/4" 24.5 cm/9 5/8" 26 cm/10 1/4" 30.5 cm/12"



ARTERY FORCEPS

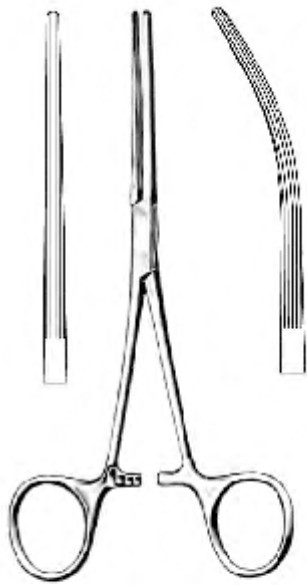

BAINBRIDGE

FM- 06-1503-15 15 cm/5 7/8" FM- 06-1504-15
 FM- 06-1503-18 18.5 cm/7 1/4" FM- 06-1504-18

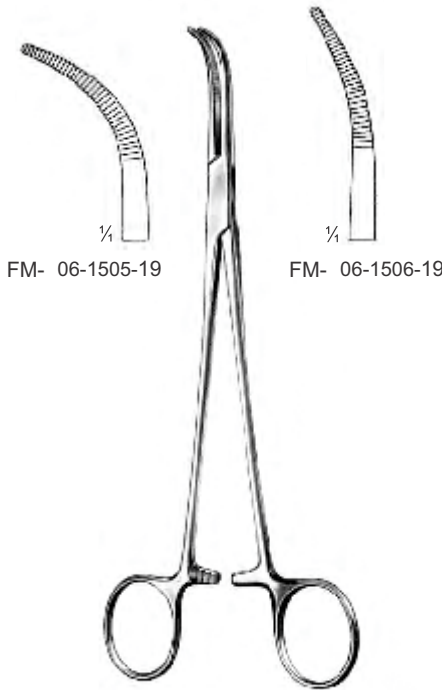

SCHNIDT

19 cm/7 1/2"

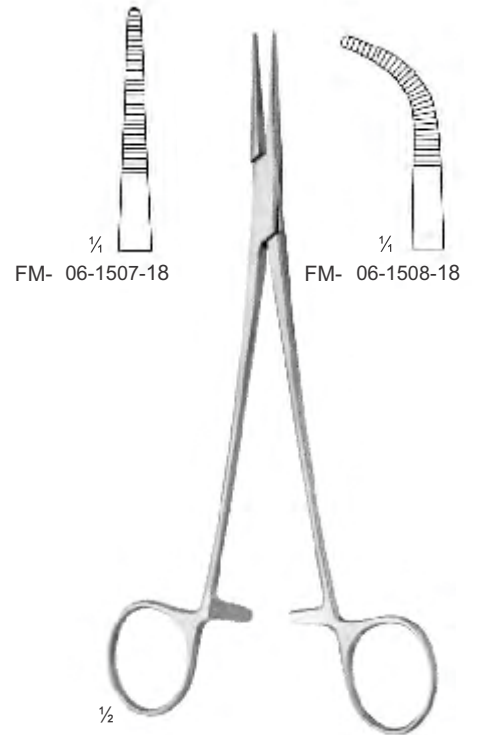

ADSON

18.5 cm/7 1/4"

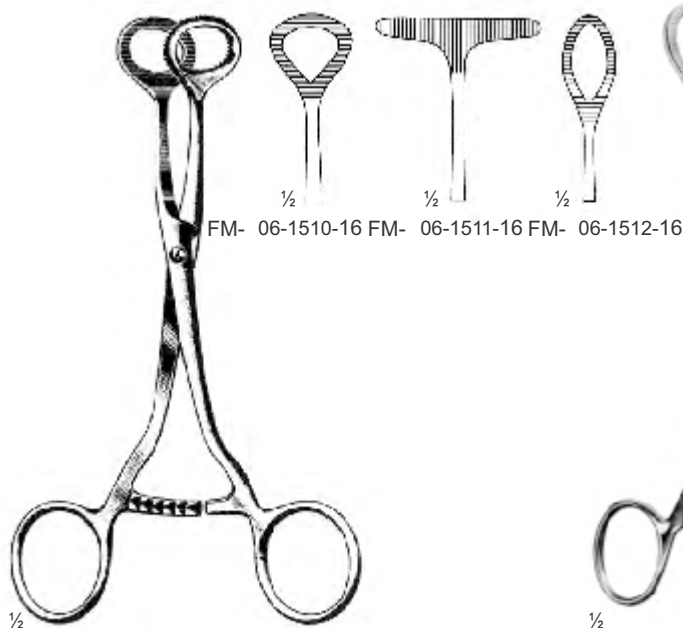

COLLIN

FM- 06-1509-16
 16 cm/6 1/4"

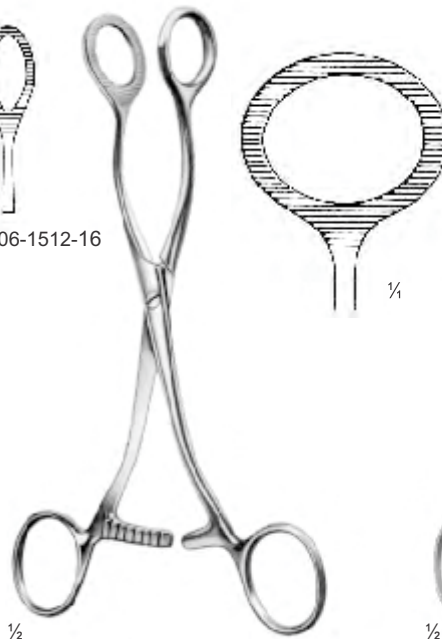

COLLIN

FM- 06-1513-16
 16.5 cm/6 1/2"

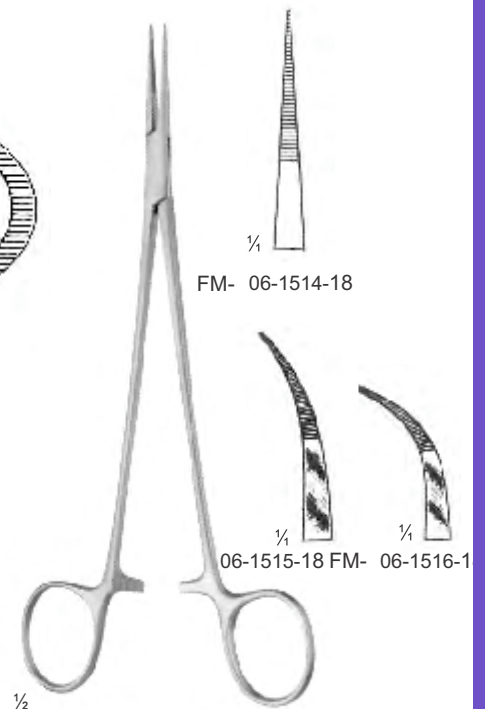

JACOBSON-MICRO

18 cm/7 1/8"



FAIZAN & MUSA
SPECIAL INSTRUMENTS



1/2

BABY-MIXTER

FM- 06-1517-18
18 cm/7 1/8"



MICRO-ADSON

FM- 06-1518-14
14 cm/5 1/2"

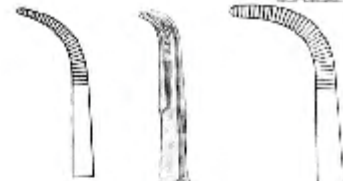

FM- 06-1519-14
14 cm/5 1/2"

FM- 06-1519-18
18 cm/7 1/8"

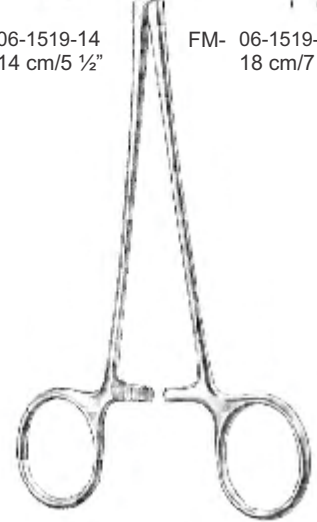

ADSON-BABY

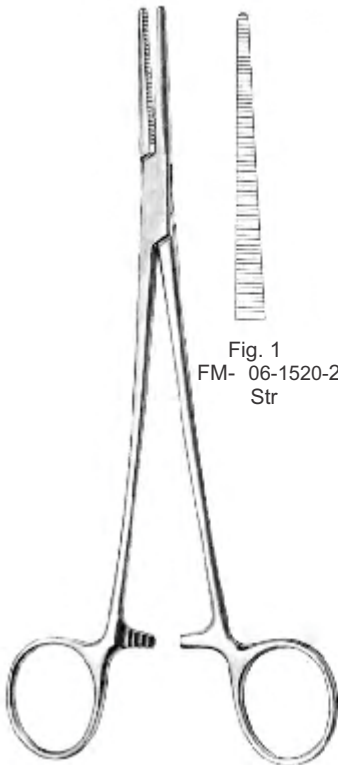

1/2

HEISS

20 cm/7 7/8"



Fig. 1
FM- 06-1520-20
Str



Fig. 2
FM- 06-1521-20
Slightly Cvd

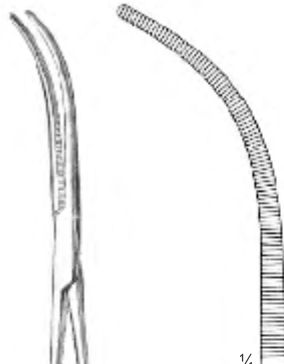
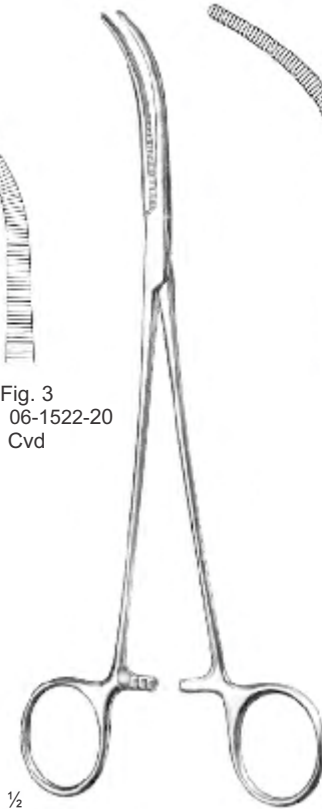

Fig. 3
FM- 06-1522-20
Cvd



1/2

OVERHOLT-MIXTER

FM- 06-1523-21
21 cm/8 1/4"



FM- 06-1524-22



FM- 06-1525-22

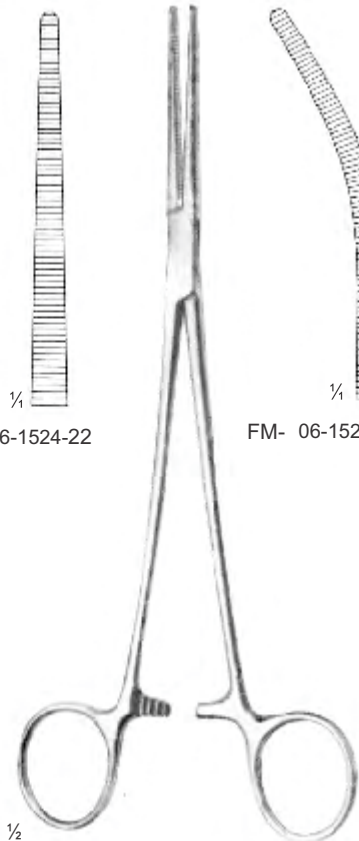

1/2

ROBERTS

22 cm/8 1/2"

ARTERY FORCEPS

- EN Dissecting and Ligature Forceps, Bile Duct Clamps
- DE Präparierklemmen, Gallenkanalklemmen
- ES Pinzas para preparación y ligadura, Pinzas para conducto biliar
- FR Pincès à dissection et à ligatures, pincès à canal biliaire
- IT Pinze per dissezione e legatura, morsetti per dotto biliare

ARTERY FORCEPS

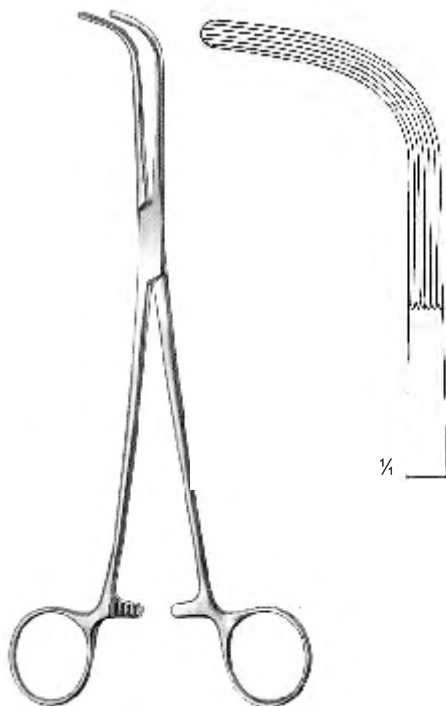

MCQUIGG-MIXTER
FM- 06-1526-23
23.5 cm/9 1/4"

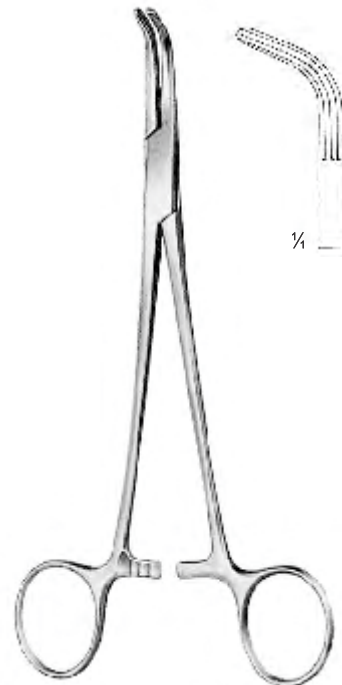

LAHEY
FM- 06-1527-18
18.5 cm/7 1/4"



LAHEY



FM- 06-1528-19
19.5 cm/7 1/2"



FM- 06-1529-22
22.5 cm/8 3/4"

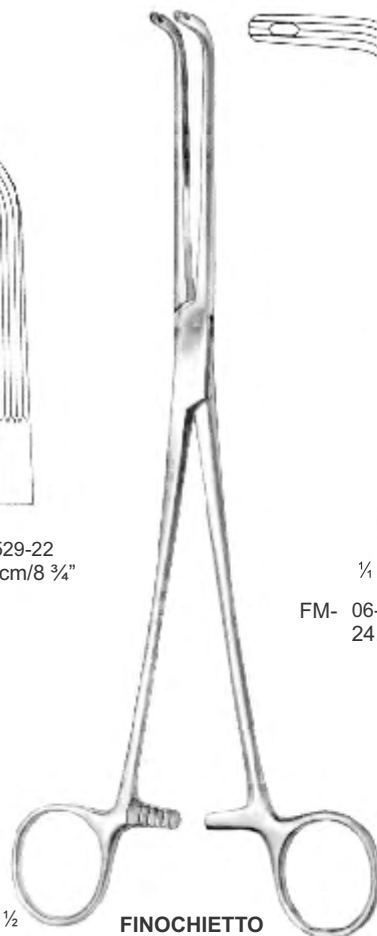

FINOCHIETTO



FM- 06-1530-24
24.5 cm/9 5/8"

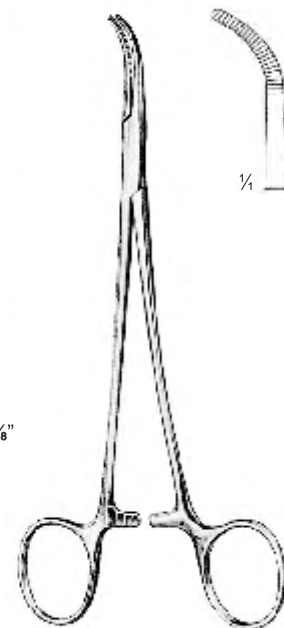

MIXTER-BABY
FM- 06-1531-14
14 cm/5 1/2"



KELLY



Fig. 1
FM- 06-1532-19
19 cm/7 1/2"



Fig. 1
FM- 06-1532-22
22.5 cm/8 3/4"



Fig. 1
FM- 06-1532-24
24.5 cm/9 5/8"



Fig. 2
FM- 06-1533-19
19 cm/7 1/2"



Fig. 2
FM- 06-1533-22
22 cm/8 1/2"



Fig. 2
FM- 06-1533-23
23.5 cm/9 1/4"



Fig. 3
FM- 06-1534-18
18.5 cm/7 1/4"



Fig. 3
FM- 06-1534-21
21.5 cm/8 1/2"



Fig. 3
FM- 06-1534-23
23.5 cm/9 1/4"

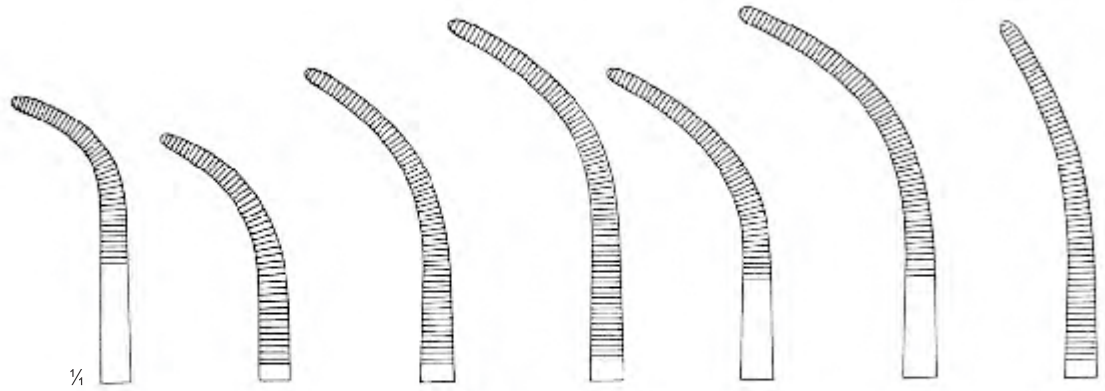

Fig. 1	Fig. 2	Fig. 3	Fig. 4	Fig. 5	Fig. 6	Fig. 7
FM- 06-1554-20	FM- 06-1555-20	FM- 06-1555-21	FM- 06-1555-22	FM- 06-1556-21	FM- 06-1556-22	FM- 06-1557-22
20.5 cm/8 1/8"	20 cm/7 7/8"	21.5 cm/8 1/2"	22 cm/8 1/2"	21.5 cm/8 1/2"	22 cm/8 1/2"	22 cm/8 1/2"

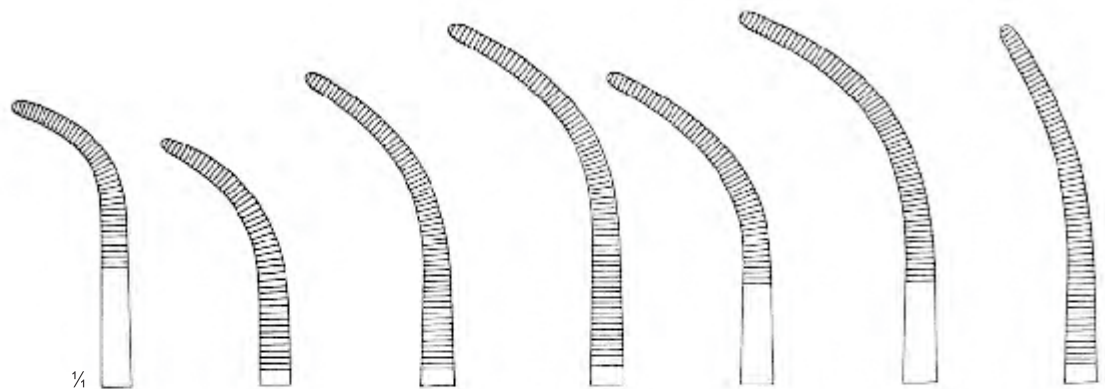
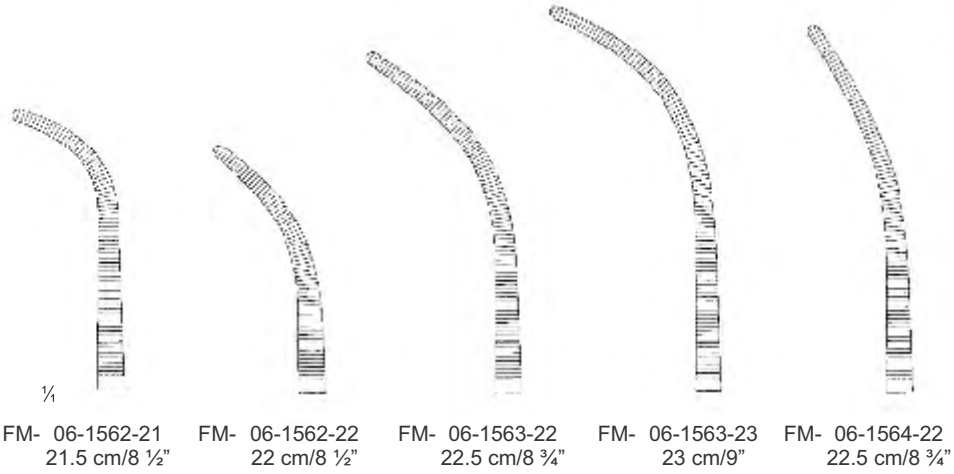

Fig. 1	Fig. 2	Fig. 3	Fig. 4	Fig. 5	Fig. 6	Fig. 7
FM- 06-1558-27	FM- 06-1558-26	FM- 06-1559-27	FM- 06-1559-28	FM- 06-1560-27	FM- 06-1560-28	FM- 06-1561-28
27 cm/10 1/2"	26.5 cm/10 3/8"	27.5 cm/10 3/4"	28 cm/11"	27.5 cm/10 3/4"	28 cm/11"	27.5 cm/10 3/4"

OVERHOLT-GEISSENDORFER



OVERHOLT-FINO



OVERHOLT-SLIM

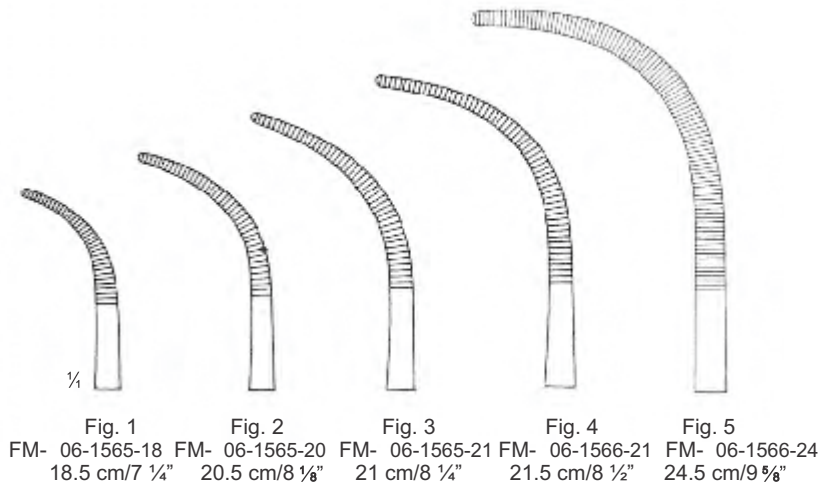

EN	Peritoneal Clamp Forceps
DE	Peritoneumklemmen
ES	Pinzas-clamps para peritoneo
FR	Pince à pince péritonéale
IT	Pinze per morsetto peritoneale

ARTERY FORCEPS

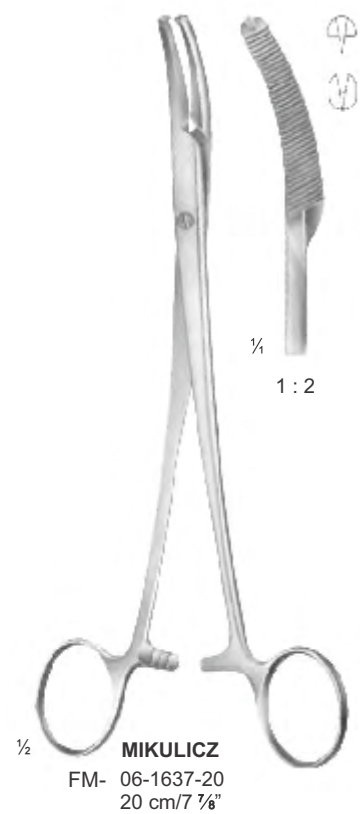
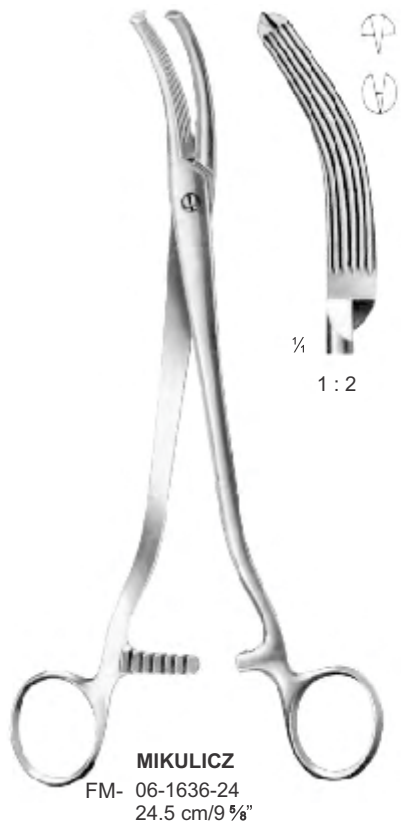
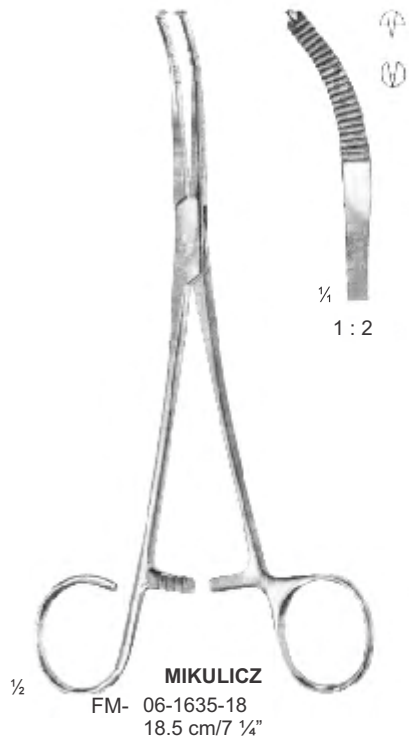
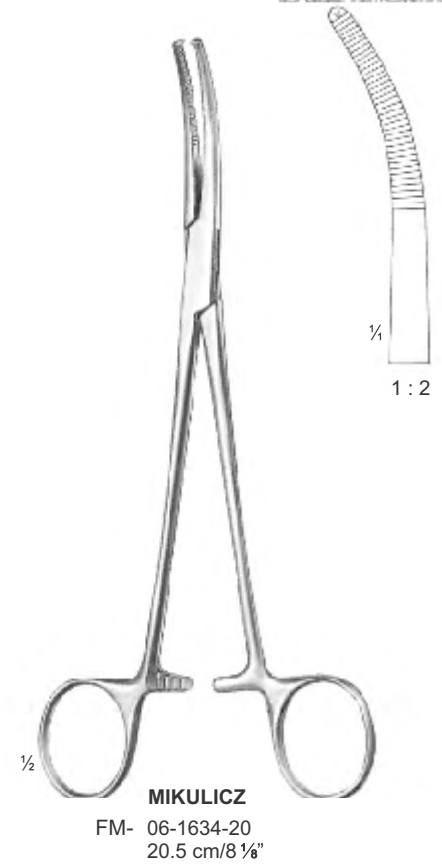
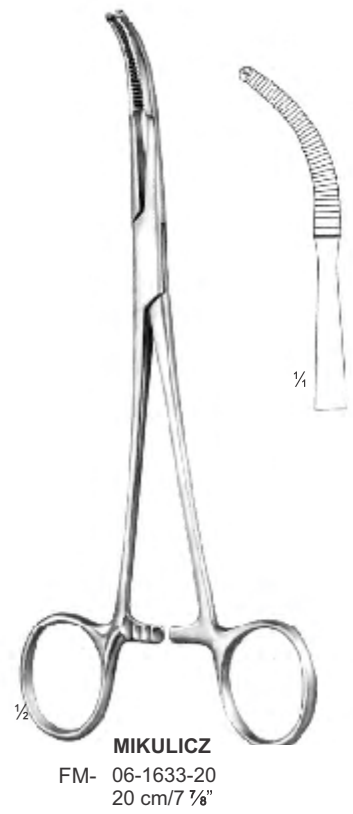
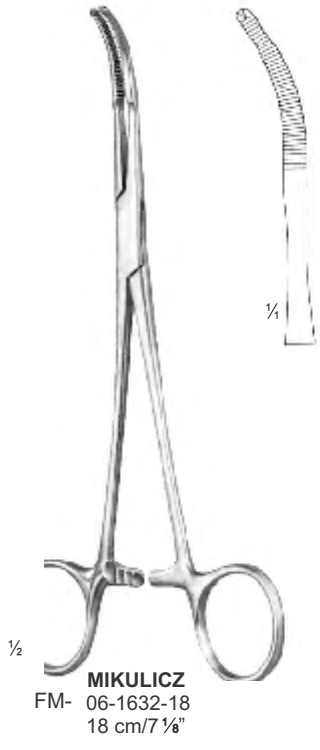

Towel Clamps	EN
Tuchklemmen	DE
Pinzas de campo	ES
Pinces à serviettes	FR
Morsetti per asciugamano	IT

06



ARTERY FORCEPS



1/2



1/2



1/2



SCHAEDEL
FM- 06-1638-09
9 cm/3 1/2"

ENGL. MODELL
FM- 06-1639-09
9 cm/3 1/2"

JONES
FM- 06-1640-05 5 cm/2"
FM- 06-1640-09 9 cm/3 1/2"

JONES
FM- 06-1641-09
9 cm/3 1/2"

DOYEN
FM- 06-1642-11
11 cm/4 3/8"

DOYEN
FM- 06-1643-18
18 cm/7 1/8"

With Clip for Tubing or Cable



BACKHAUS

06-1644-11 11 cm/4 3/8"
06-1644-13 13 cm/5 1/8"

Delicate pattern, sharp



1/2

BACKHAUS

FM- 06-1645-11
11 cm/4 3/8"

With Clip for Tubing or Cable

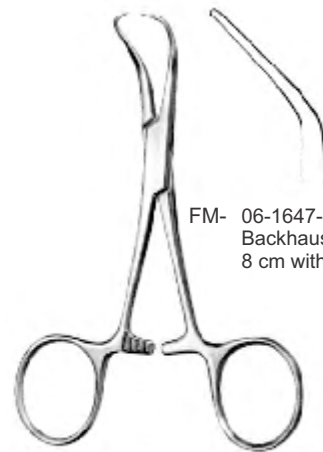

FM- 06-1647-08
Backhaus Towel
8 cm with open jaws

BACKHAUS

FM- 06-1646-08 8 cm/3 1/4"
FM- 06-1646-08 11 cm/4 3/8"
FM- 06-1646-08 13 cm/5 1/8"
FM- 06-1646-08 15 cm/5 7/8"

EN	Towel Clamps
DE	Tuchklemmen
ES	Pinzas de campo
FR	Pinces à serviettes
IT	Morsetti per asciugamano



FAIZAN & MUSA



BALL & SOCKET

FM- 06-1648-11 11.5 cm/4 1/2"

FM- 06-1648-14 14 cm/5 1/2"

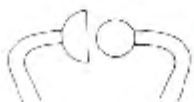

TOHOKU

FM- 06-1649-10 10.5 cm/4 1/8"

FM- 06-1649-13 13.5 cm/5 3/8"

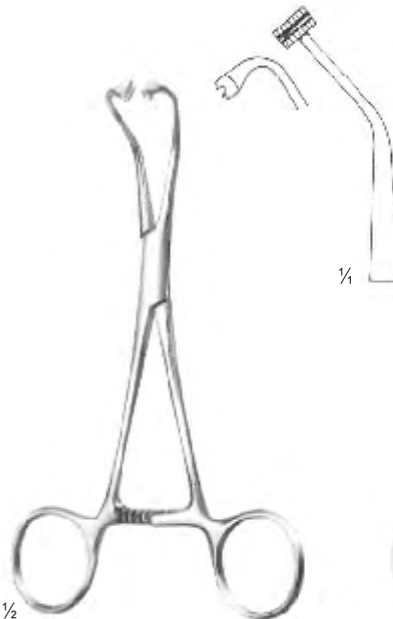

PEERS BERTRAM

FM- 06-1650-14 14.5 cm/5 3/4"



PEERS-BERTRAM MODIF.

FM- 06-1651-15 15.5 cm/6 1/8"

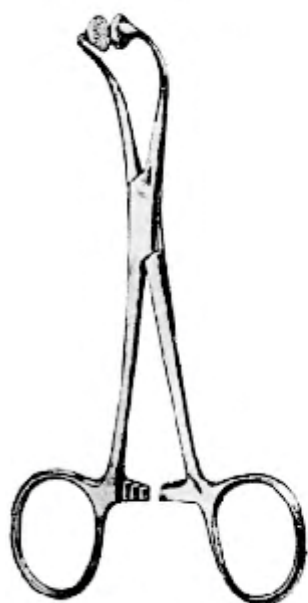

HOFF

FM- 06-1652-11 11 cm/4 3/8"
FM- 06-1652-14 14.5 cm/5 3/4"



ROBIN

FM- 06-1653-13 13.5 cm/5 3/8"
with holder for cable up to 5 mm



ROBIN

FM- 06-1654-13 13.5 cm/5 3/8"
with holder for cable up to 13 mm tubing

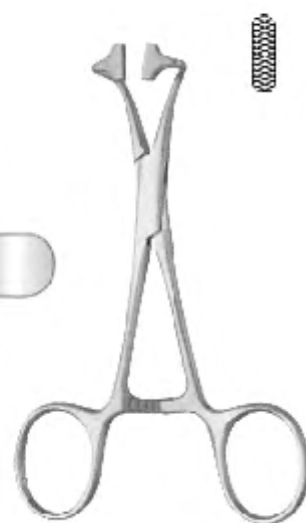

PAPER TOWEL FORCEPS

FM- 06-1655-10 10 cm/3 7/8"
FM- 06-1655-13 13 cm/5 1/8"



ROEDER
 FM- 06-1656-13 13 cm/5 1/8"
 FM- 06-1656-15 15 cm/5 7/8"



LORNA
 FM- 06-1657-10 10 cm/3 7/8"
 FM- 06-1657-13 13 cm/5 1/8"



BERNHARD
 FM- 06-1658-16
 16.5 cm/6 1/2"



LANE
 FM- 06-1659-20
 20 cm/7 7/8"

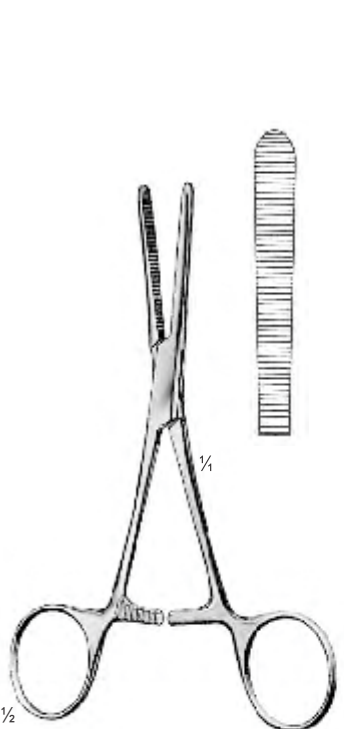

FM- 06-1660-14
 14.5 cm/5 3/4"
 with extra long ratchet

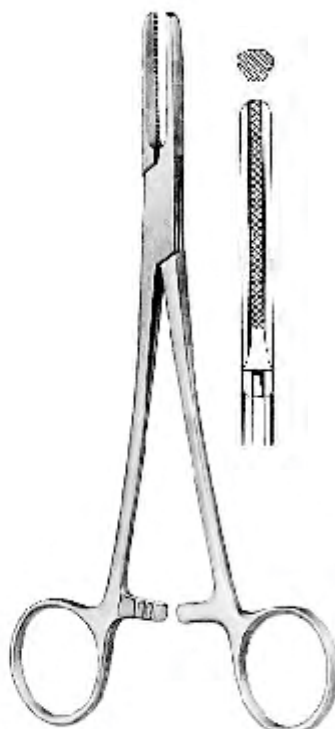

SCHOENBERG
 FM- 06-1661-15 15.5 cm/6 1/8"
 FM- 06-1661-19 19 cm/7 1/2"
 FM- 06-1661-20 20 cm/7 7/8"



SCHOENBERG
 FM- 06-1662-15 15.5 cm/6 1/8"
 FM- 06-1662-19 19 cm/7 1/2"
 FM- 06-1662-20 20 cm/7 7/8"
 with safety guard

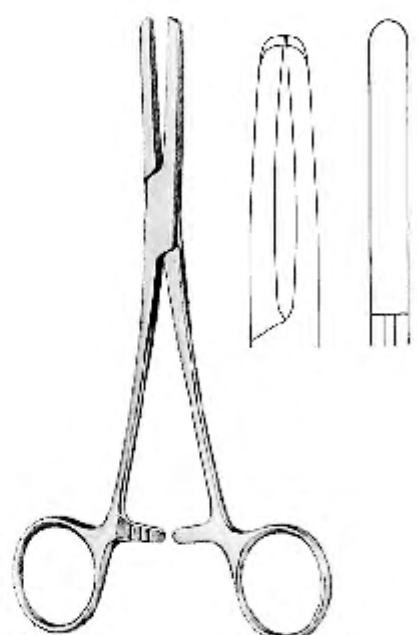

PRESBYTERIAN-HOSPITAL
 FM- 06-1663-15 15.5 cm/6 1/8"
 FM- 06-1663-19 19 cm/7 1/2"
 FM- 06-1663-20 20 cm/7 7/8"

EN	Cotton Swab Forceps	Page 71 to 76
DE	Tupfer-und Kornzangen	
ES	Pinzas para tapones y curaciones	
FR	Forceps de coton-tige	
IT	Pinza per tampone di cotone	



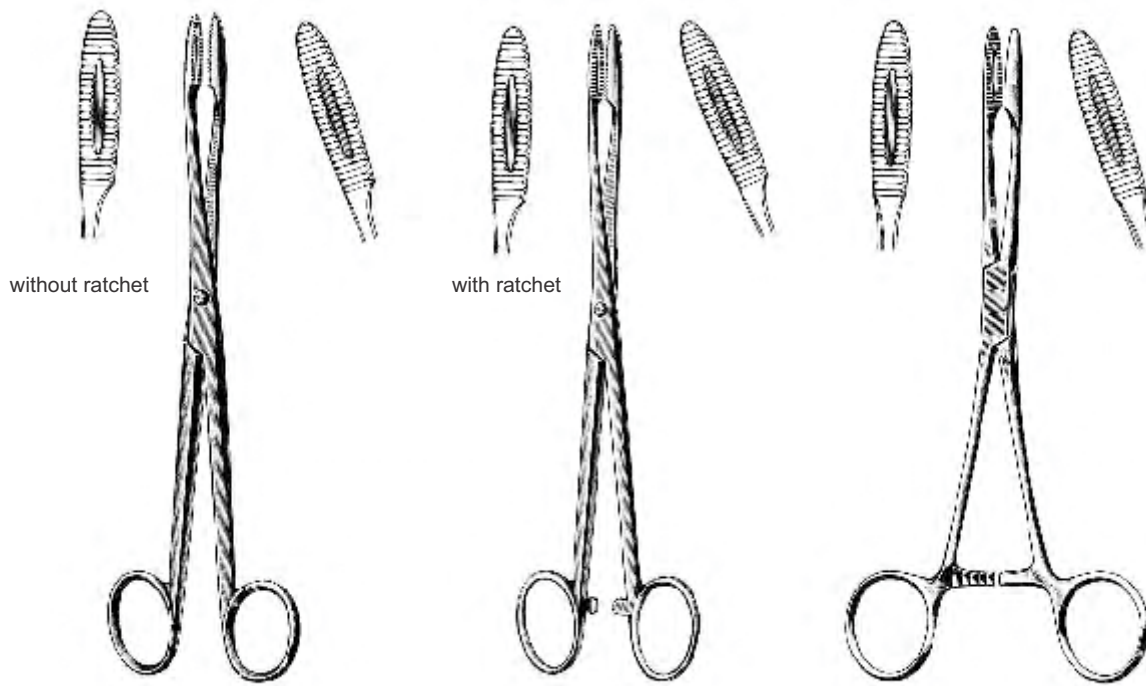

GROSS-MAIER				GROSS-MAIER				GROSS-MAIER			
straight		curved		straight		curved		straight		curved	
cm	in	cm	in	cm	in	cm	in	cm	in	cm	in
14.5	5 3/4"	16	6 1/4"	14	5 1/2"	16	6 1/4"	20	7 7/8"	22	8 1/2"
16	6 1/4"	18	7 1/8"	16	6 1/4"	18	7 1/8"	22	8 1/2"	25	9 7/8"
18	7 1/8"	20	7 7/8"	18	7 1/8"	20	7 7/8"	25	9 7/8"		
20	7 7/8"	25	9 7/8"	20	7 7/8"	25	9 7/8"				
25	9 7/8"			25	9 7/8"						

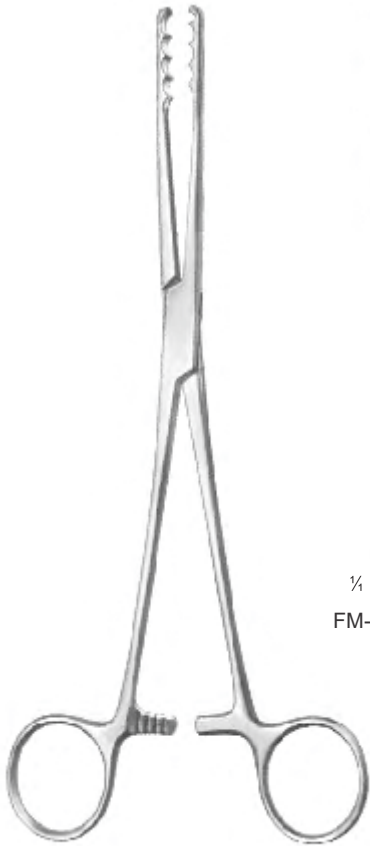

ULRICH

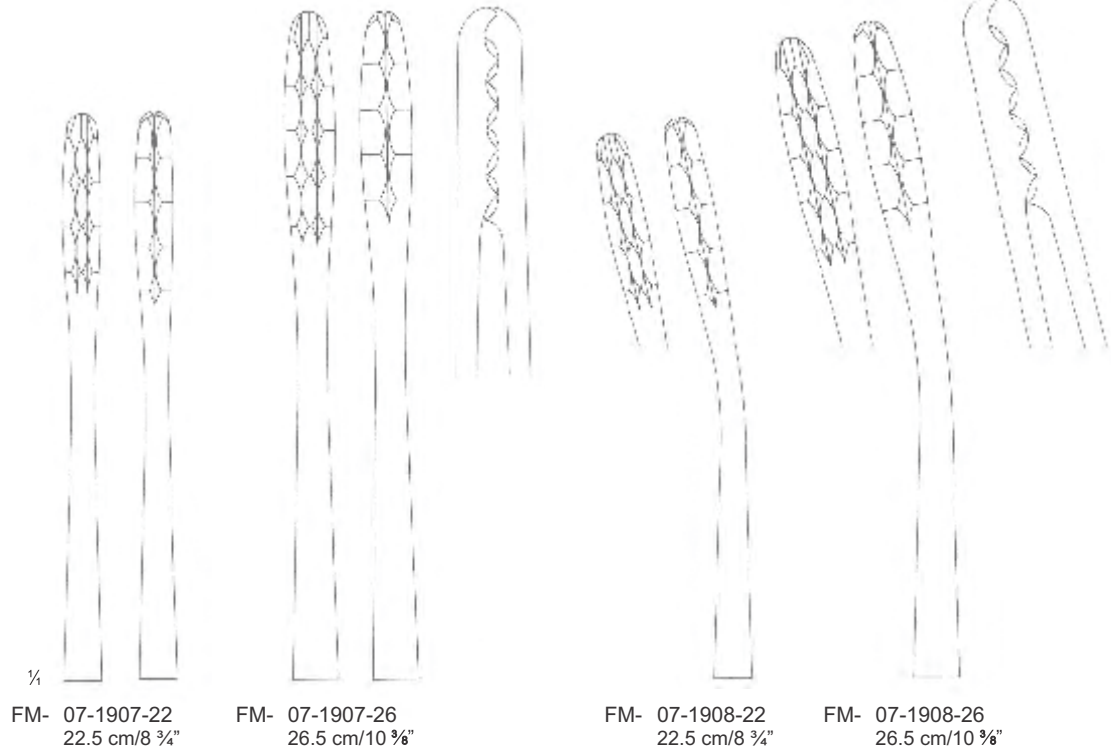

FM- 07-1907-22
 22.5 cm/8 3/4"

FM- 07-1907-26
 26.5 cm/10 3/8"

FM- 07-1908-22
 22.5 cm/8 3/4"

FM- 07-1908-26
 26.5 cm/10 3/8"



EMMET
 FM- 07-1909-21
 21 cm/8 1/4"

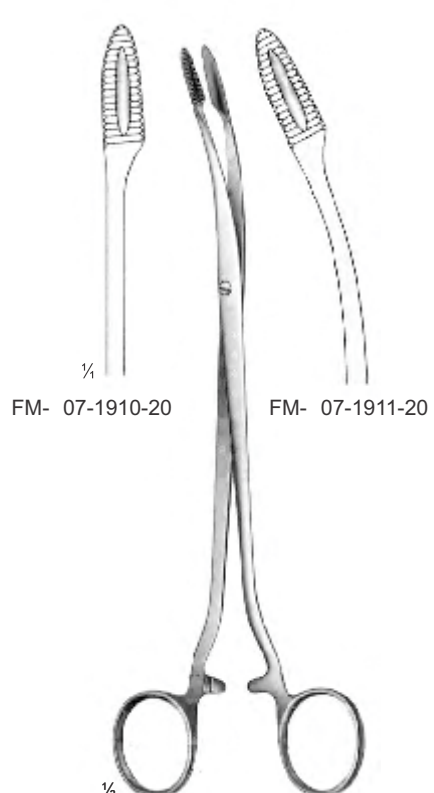

DUPLAY
 20 cm/7 7/8"

COTTON SWAB FORCEPS

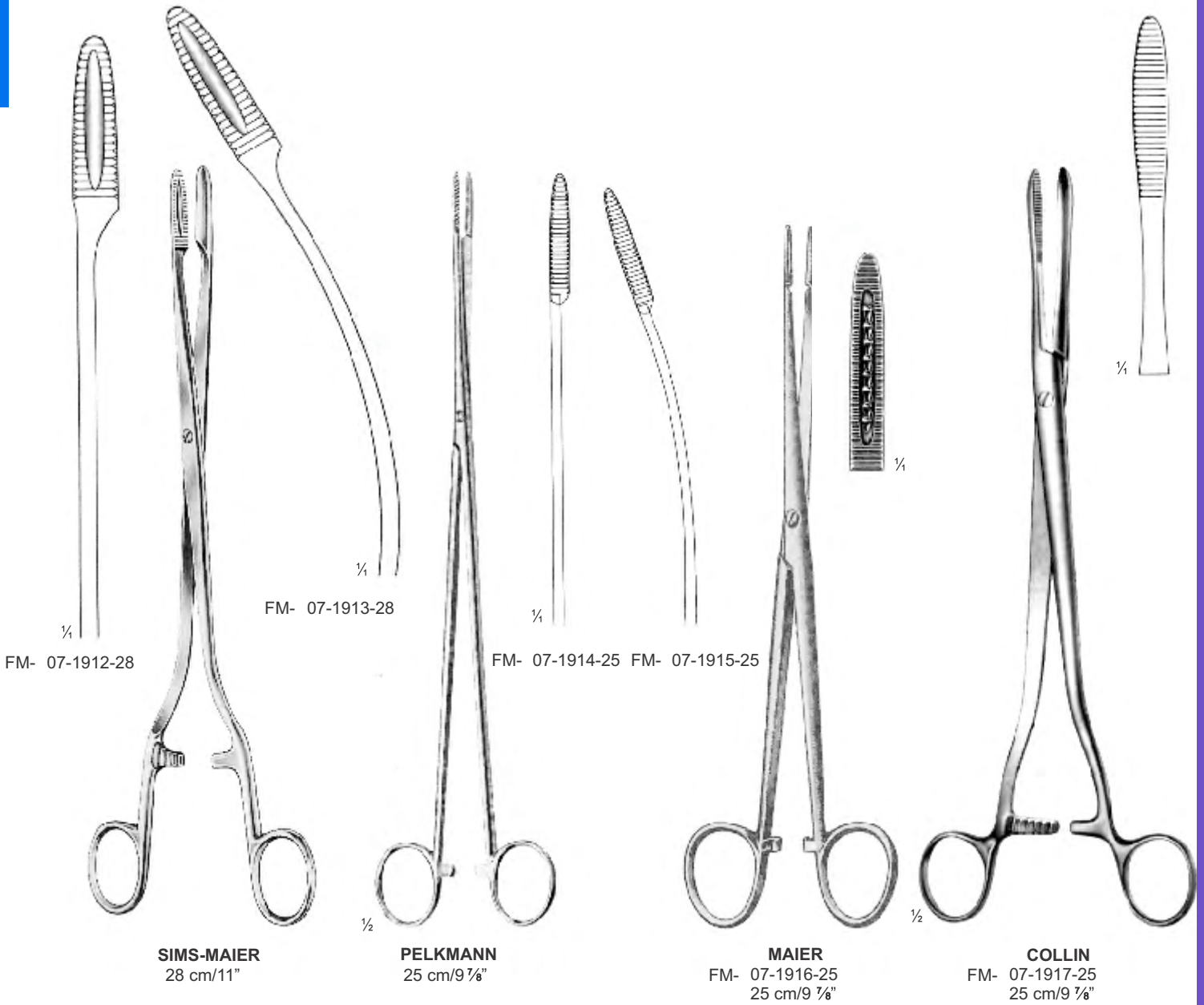

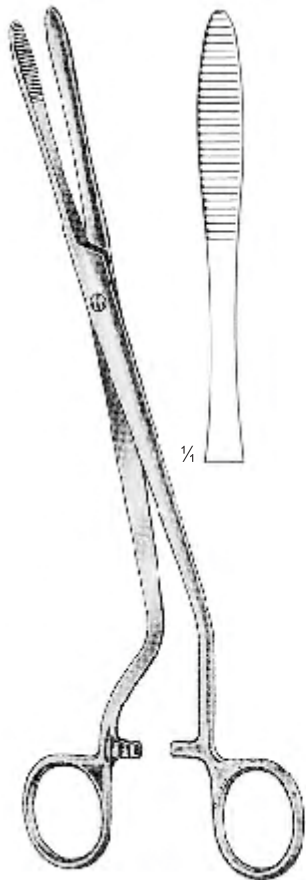

CHERON
 FM- 07-1918-25
 25 cm/9 7/8"

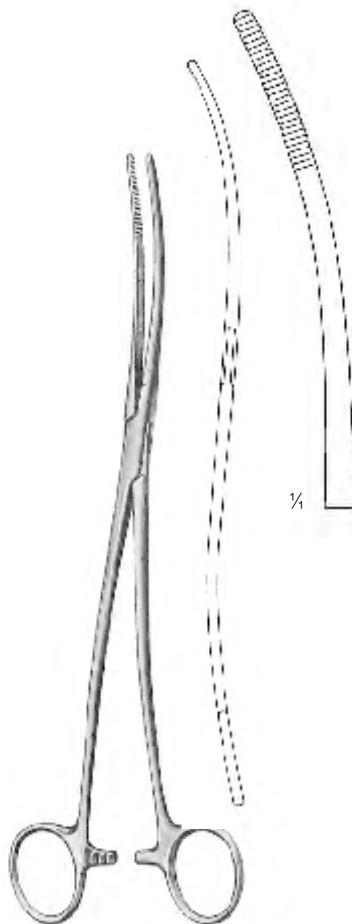

BOZEMANN
 FM- 07-1919-26
 26 cm/10 1/4"
 S-shaped

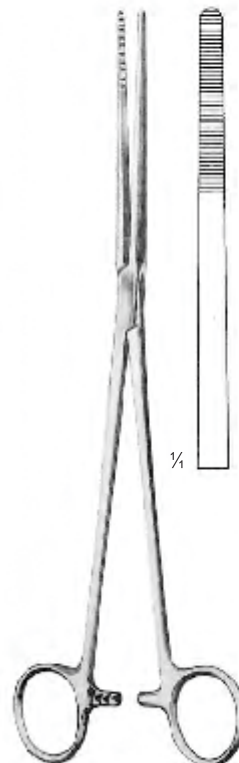

BOZEMANN
 FM- 07-1920-26
 26 cm/10 1/4"

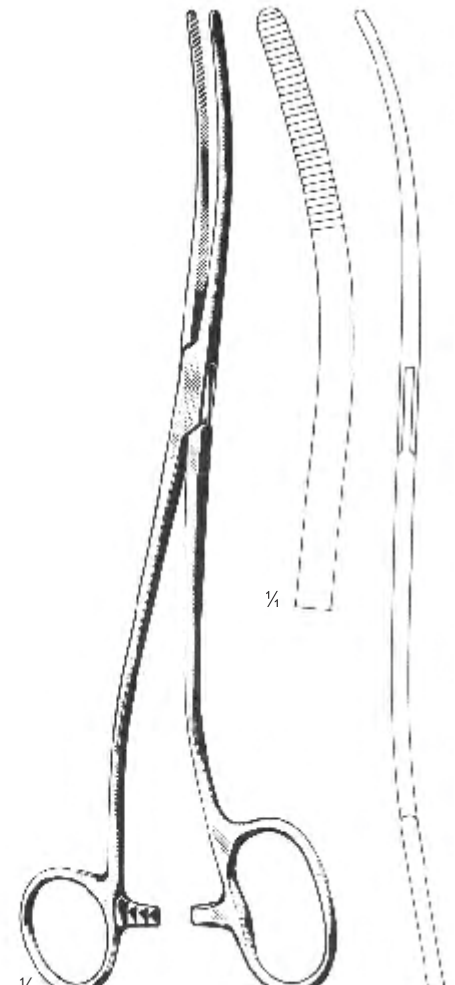

BOZEMANN DOUGLAS
 FM- 07-1921-26
 26 cm/10 1/4"



FOERSTER

18 cm/7 1/8" FM- 07-1922-18
 20 cm/7 7/8" FM- 07-1922-20
 25 cm/9 7/8" FM- 07-1922-25



FM- 07-1923-18
 FM- 07-1923-20
 FM- 07-1923-25

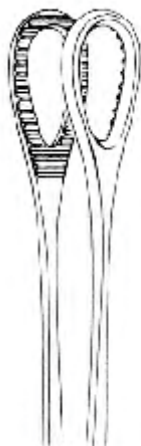

FM- 07-1924-18
 FM- 07-1924-20
 FM- 07-1924-25



FM- 07-1925-18
 FM- 07-1925-20
 FM- 07-1925-25

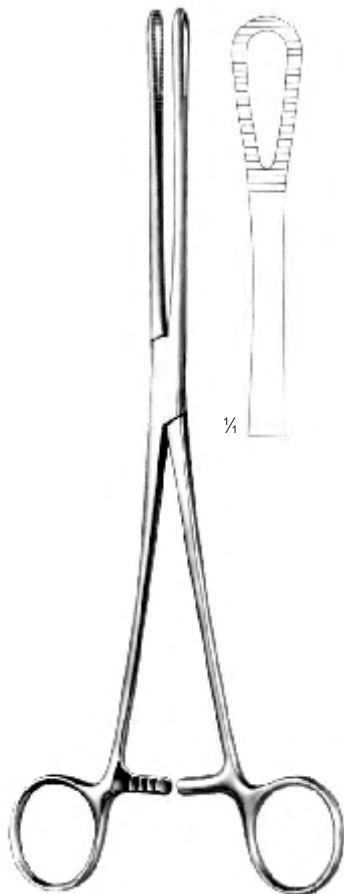

RAMPLEY

FM- 07-1926-18 18.5 cm/7 1/4"
 FM- 07-1926-24 24.5 cm/9 5/8"

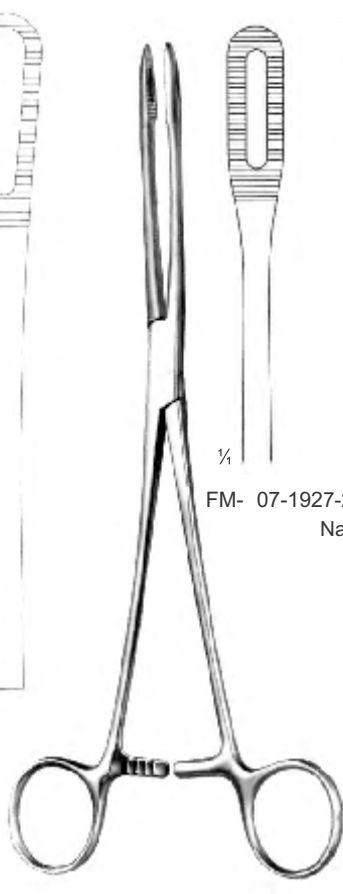

FOERSTER

25 cm/9 7/8"

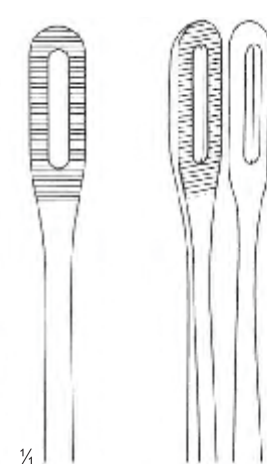

FM- 07-1927-25 FM- 07-1928-25
 Narrow

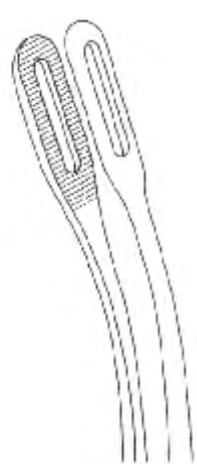

FM- 07-1929-25

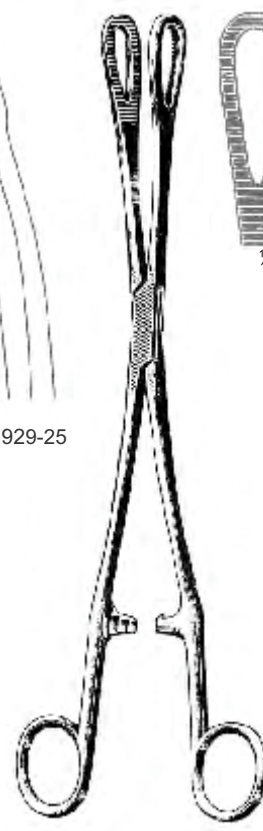

RAMPLEY

FM- 07-1930-25
 25 cm/9 7/8"



BERGMANN-FOERSTER
 FM- 07-1931-24
 24 cm/9 1/2"

BERGMANN-FOERSTER
 FM- 07-1932-24
 24 cm/9 1/2"

FLETCHER (JAVERTS)
 FM- 07-1933-24
 24 cm/9 1/2"

FLETCHER (JAVERTS)
 FM- 07-1934-24
 24 cm/9 1/2"

EN	Probes, Applicators, Spatulas	Page 77 to 79
DE	Sonden, Watteträger, Spatel	
ES	Sondas, Porta-algodones, Espátula	
FR	Sondes, applicateurs, spatules	
IT	Sonde, applicatori, Spatole	



EN	Probes
DE	Knopfsonden
ES	Sondas abotonadas
FR	Sondes
IT	sonde

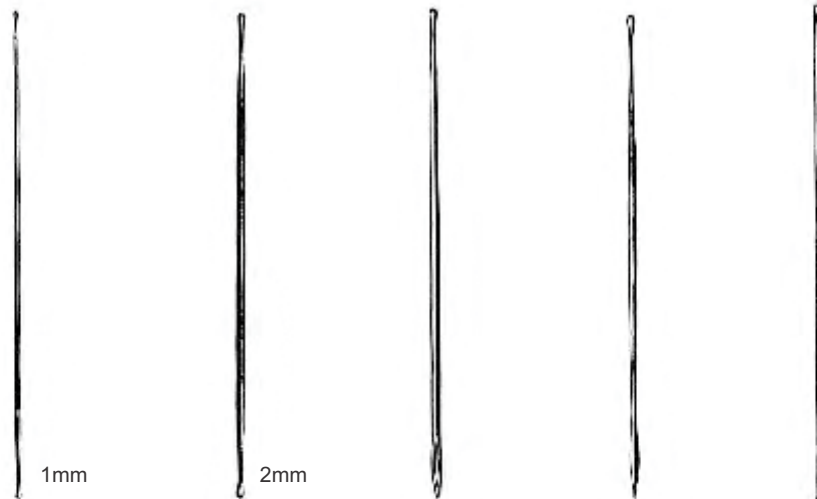

	1mm		2mm			
11.5cm FM-	08-2001-11	FM-	08-2002-11	FM-	08-2003-11	
12.5cm FM-	08-2001-12	FM-	08-2002-12	FM-	08-2003-12	FM- 08-2004-12
14.0cm FM-	08-2001-14	FM-	08-2002-14	FM-	08-2003-14	FM- 08-2004-14
16.0cm FM-	08-2001-16	FM-	08-2002-16	FM-	08-2003-16	FM- 08-2004-16
18.0cm FM-	08-2001-18	FM-	08-2002-18	FM-	08-2003-18	FM- 08-2004-18
20.0cm FM-	08-2001-20	FM-	08-2002-20	FM-	08-2003-20	FM- 08-2004-20
25.0cm FM-	08-2001-25	FM-	08-2002-25	FM-	08-2003-25	FM- 08-2005-12
						FM- 08-2005-14
						FM- 08-2005-16
						FM- 08-2005-18
						FM- 08-2005-20



		Silver		FISH	FISH
10.5cm FM-	08-2006-10	11.5cm FM-	08-2007-11	FM- 08-2008-11	FM- 08-2009-14
13.0cm FM-	08-2006-13	12.5cm FM-	08-2007-12	FM- 08-2008-12	FM- 08-2009-18
14.5cm FM-	08-2006-14	14.0cm FM-	08-2007-14	FM- 08-2008-14	14.5cm FM-
16.0cm FM-	08-2006-16	16.0cm FM-	08-2007-16	FM- 08-2008-16	08-2010-10
18.0cm FM-	08-2006-18	18.0cm FM-	08-2007-18	FM- 08-2008-18	18.0cm
20.0cm FM-	08-2006-20	20.0cm FM-	08-2007-20	FM- 08-2008-20	10.0cm
		25.0cm FM-	08-2007-25	FM- 08-2008-25	



11.5cm FM- 08-2011-11
 12.5cm FM- 08-2011-12
 14.0cm FM- 08-2011-14
 16.0cm FM- 08-2011-16
 18.0cm FM- 08-2011-18
 20.0cm FM- 08-2011-20



FM- 08-2012-11
 FM- 08-2012-12
 FM- 08-2012-14
 FM- 08-2012-16
 FM- 08-2012-18
 FM- 08-2012-20



DOYEN
 FM- 08-2013-14
 14.0cm



NELATON
 FM- 08-2014-16
 16.0cm



FM- 08-2015-12
 12.0cm



KRONECKER
 FM- 08-2016-16
 13.0 cm



JOHNS-HOPKINS
 FM- 08-2017-15
 15.0 cm



ROSER
 FM- 08-2018-12
 12.5 cm



SYME
 FM- 08-2019-17
 17.0 cm



FM- 08-2020-17
 17.0 cm

EN Cotton Applicators
 DE Watteträger
 ES Porta-algodones
 FR Appicateurs de coton
 IT Applicatori di cotone

PROBES, APPLICATORS,
 SPATULAS

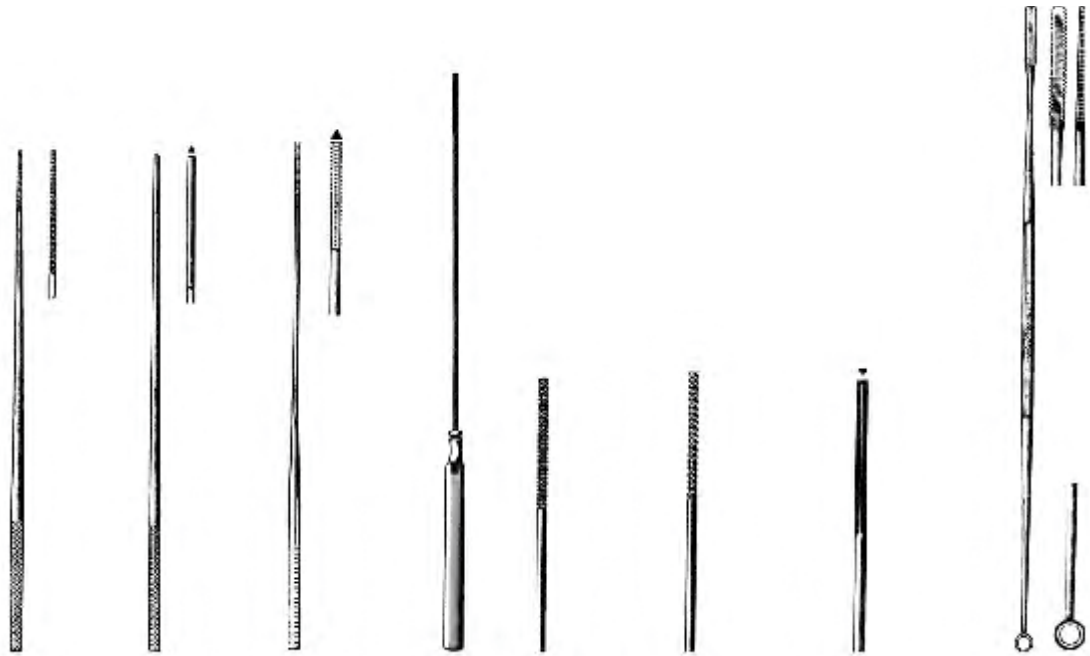

FARREL

- 12.0cm FM- 08-2029-12
- 14.0cm FM- 08-2029-14
- 16.0cm FM- 08-2029-16
- 18.0cm FM- 08-2029-18
- 23.0cm FM- 08-2029-23

FARREL

- FM- 08-2030-12
- FM- 08-2030-14
- FM- 08-2030-16
- FM- 08-2030-18
- FM- 08-2030-23

FARREL

- FM- 08-2031-12
- FM- 08-2031-14
- FM- 08-2031-16
- FM- 08-2031-18
- FM- 08-2031-23

- FM- 08-2032-12
- FM- 08-2032-14
- FM- 08-2032-16
- FM- 08-2032-18

- FM- 08-2033-12
- FM- 08-2033-14
- FM- 08-2033-16
- FM- 08-2033-18

- FM- 08-2034-12
- FM- 08-2034-14
- FM- 08-2034-16
- FM- 08-2034-18

JOBSON-HORNE

- FM- 08-2035-12 12.5 cm
- FM- 08-2035-18 18.0 cm



JOBSON-HORNE

- FM- 08-2036-15 15.0 cm
- FM- 08-2037-16 16.0 cm
- FM- 08-2038-25 25.0 cm
- FM- 08-2039-28 28.0 cm
- FM- 08-2040-28 28.0 cm
- FM- 08-2041-28 28.0 cm

- EN** Bone Surgery
- DE** Knochenchirurgie
- ES** Cirugía ósea
- FR** Chirurgie osseuse
- IT** Chirurgia ossea

Page 80 to 114



EN	Mallets
DE	Hämmer
ES	Martillos
FR	Maillets
IT	Mallets



FAIZAN & MUSA
SPECIAL INSTRUMENTS

BONE SURGERY



Mead
FM- 09-2201-17 17 cm/6 1/2"
26mm Ø,320 g (11 1/4 oz)



Partsch
FM- 09-2202-18 18 cm/7"
22mm Ø,200 g (7 oz)



FM- 09-2203-30
30mm Ø,510 g



FM- 09-2204-26 250 g
FM- 09-2205-26 450 g
26.5 cm/10 3/4"



FM- 09-2206-18 18.5 cm/7 1/2"
25mm Ø 135 g



FM- 09-2207-19 19 cm/7 3/4"
22mm Ø 155 g

lead lled



Hajek
FM- 09-2208-22 22 cm/8 3/4"
27mm Ø 130 g



Width

mm **Partsch**
 02 FM- 09-2224-02
 03 FM- 09-2224-03
 04 FM- 09-2224-04
 05 FM- 09-2224-05
 06 FM- 09-2224-06
 07 FM- 09-2224-07
 08 FM- 09-2224-08
 13.5 cm/5¼"

FM- 09-2225-02
 FM- 09-2225-03
 FM- 09-2225-04
 FM- 09-2225-05
 FM- 09-2225-06
 FM- 09-2225-07
 FM- 09-2225-08
 17 cm/6¾"

Partsch
 FM- 09-2226-02 FM- 09-2227-02
 FM- 09-2226-03 FM- 09-2227-03
 FM- 09-2226-04 FM- 09-2227-04
 FM- 09-2226-05 FM- 09-2227-05
 FM- 09-2226-06 FM- 09-2227-06
 FM- 09-2226-07 FM- 09-2227-07
 FM- 09-2226-08 FM- 09-2227-08
 13.5 cm/5¼" 17cm/6¾"

mm
 04 FM- 09-2228-04 FM- 09-2229-04 FM- 09-2230-04
 06 FM- 09-2228-06 FM- 09-2229-06 FM- 09-2230-06
 08 FM- 09-2228-08 FM- 09-2229-08 FM- 09-2230-08
 10 FM- 09-2228-10 FM- 09-2229-10 FM- 09-2230-10
 12 FM- 09-2228-12 FM- 09-2229-12 FM- 09-2230-12
 14 FM- 09-2228-14 FM- 09-2229-14 FM- 09-2230-14
 16 FM- 09-2228-16 FM- 09-2229-16 FM- 09-2230-16
 13.5 cm/5"

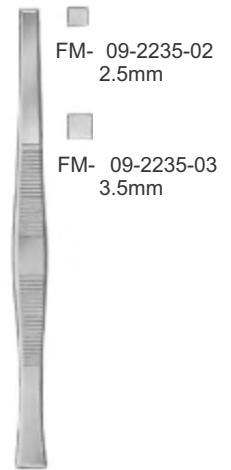
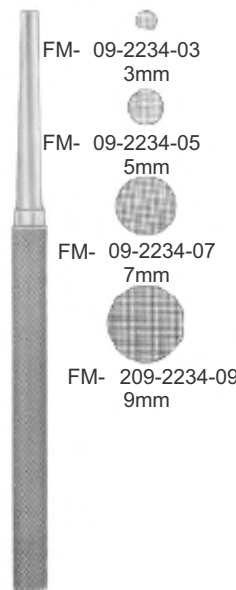

mm
 06FM- 09-2231-06
 12FM- 09-2231-12
 18FM- 09-2231-18

Mod. USA
 FM- 09-2232-06
 FM- 09-2232-12
 FM- 09-2232-18
 16 cm/6¼"

FM- 09-2233-06
 FM- 09-2233-12
 FM- 09-2233-18

16 cm/6¼"

Passow
 12 cm/4¾"

EN	Bone Chisels, Gauges
DE	Knochenmeißel, Hohlmeißel
ES	Cinceles, Gubias
FR	Burins à os, jauges
IT	Bone scalpelli, calibri



Alexander
18 cm/7"

	mm	
FM- 09-2246-04	04	FM- 09-2247-04
FM- 09-2246-06	06	FM- 09-2247-06
FM- 09-2246-08	08	FM- 09-2247-08
FM- 09-2246-10	10	FM- 09-2247-10
FM- 09-2246-12	12	FM- 09-2247-12
FM- 09-2246-14	14	FM- 09-2247-14

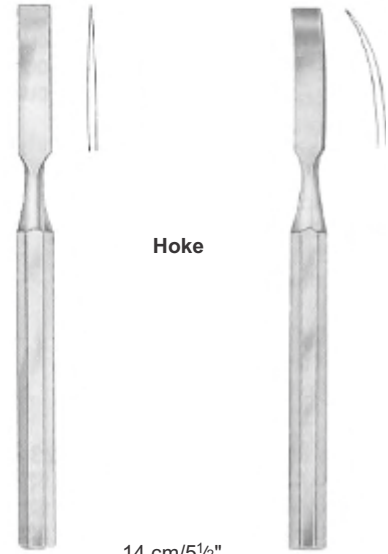

Hoke

14 cm/5½"

	mm	
FM- 09-2248-02	2	FM- 09-2249-02
FM- 09-2248-03	3	FM- 09-2249-03
FM- 09-2248-04	4	FM- 09-2249-04
FM- 09-2248-05	5	FM- 09-2249-05
FM- 09-2248-06	6	FM- 09-2249-06
FM- 09-2248-07	7	FM- 09-2249-07
FM- 09-2248-08	8	FM- 09-2249-08

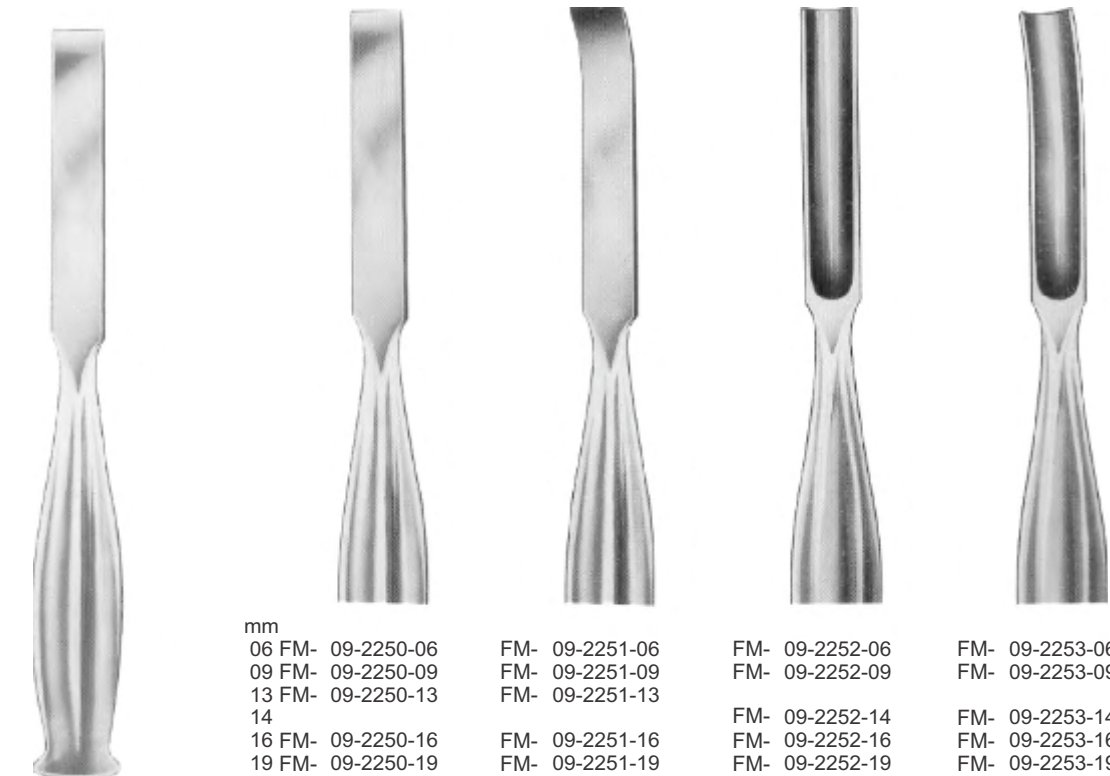

Smith-Petersen
20 cm/8"

	mm			
06	FM- 09-2250-06	FM- 09-2251-06	FM- 09-2252-06	FM- 09-2253-06
09	FM- 09-2250-09	FM- 09-2251-09	FM- 09-2252-09	FM- 09-2253-09
13	FM- 09-2250-13	FM- 09-2251-13		
14				
16	FM- 09-2250-16	FM- 09-2251-16	FM- 09-2252-14	FM- 09-2253-14
19	FM- 09-2250-19	FM- 09-2251-19	FM- 09-2252-16	FM- 09-2253-16
25	FM- 09-2250-25	FM- 09-2251-25	FM- 09-2252-19	FM- 09-2253-19
32	FM- 09-2250-32	FM- 09-2251-32	FM- 09-2252-25	FM- 09-2253-25
			FM- 09-2252-32	FM- 09-2253-32

Bone Chisels, Gauges **EN**
 Knochenmeißel, Hohlmeißel **DE**
 Cinceles, Gubias **ES**
 Burins à os, jauges **FR**
 Bone scalpelli, calibri **IT**

09



FAIZAN & MUSA
 SPECIAL INSTRUMENTS

BONE SURGERY



Lambotte
 21 cm/8¼"

	mm
FM- 09-2305-21	05
FM- 09-2306-21	10
FM- 09-2307-21	15
FM- 09-2308-21	20
FM- 09-2309-21	25

Width



Schneider
 09-2310-17
 13 mm
 17.5 cm/7"



Schneider-Sauerbruch
 FM- 09-2311-19
 13 mm
 19 cm/7½"



Alexander
 FM- 09-2312-20
 20 cm/8"



Jansen
 FM- 09-2313-16
 15 mm
 16.5 cm/6½"



Seldin
 FM- 09-2314-19
 19 cm/7½"



Davidson-Alexander
 FM- 09-2315-29
 29 cm/11½"



Williger
 FM- 09-2316-13
 13 cm/5"

EN	Bone Chisels, Gauges
DE	Knochenmeißel, Hohlmeißel
ES	Cinceles, Gubias
FR	Burins à os, jauges
IT	Bone scalpelli, calibri

BONE SURGERY



Farabeuf
FM- 09-2325-15
15 cm/6"



Farabeuf
FM- 09-2326-15
15 cm/6"



Farabeuf-Collin
FM- 09-2327-15
15.5 cm/6"
11 mm



Farabeuf-Collin
FM- 09-2328-15
15.5 cm/6"
11 mm



Farabeuf
FM- 09-2329-19
19 cm/7 1/2"
13 mm



Sedillot
FM- 09-2330-18
18 cm/7"
18 mm



Sedillot
FM- 09-23301-21
21 cm/8 1/4"
15 mm



LANGENBECK



FM- 09-2332-19
19.0cm,16mm

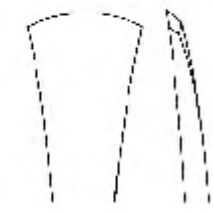

FM- 09-2333-19
19.0cm,16cm



FM- 09-2334-19
19.0cm,12mm



FM- 09-2335-18
18.0cm,12mm

Periosteal Elevators EN

Raspatorien DE

Periostótomos ES

Ascenseurs périostés FR

Ascensori periostale IT

09



FAIZAN & MUSA
SPECIAL INSTRUMENTS

BONE SURGERY



Overholt
FM- 09-2336-29
29.5 cm/11½"



Overholt
FM- 09-2337-29
29.5 cm/11½"



Overholt
FM- 09-2338-28
28.5 cm/11¼"



Hylin FM- 09-2341-14
14.5 cm/5¾"



FM- 09-2339-14



FM- 09-2340-14



Matson
FM- 09-2342-22
22 cm/8¾"



Spare Saw Blade
 FM- 09-2435-12 12mm
 FM- 09-2435-15 15mm
 FM- 09-2435-18 18mm



Chaarriere
 FM- 09-2436-35
 35 cm/14"



Spare Saw Blade
 FM- 09-2437-03 3mm
 FM- 09-2437-05 5mm
 FM- 09-2437-07 7mm



Helferich-Bier
 FM- 09-2438-39
 39 cm/15 3/4"



Lindemann
 FM- 09-2439-20
 20 cm/8"



Langenbeck
 FM- 09-2440-23
 23 cm/9"

FM- 09-2441-06 6mm
 FM- 09-2441-08 8mm
 FM- 09-2441-12 12mm
 FM- 09-2441-15 15mm
 FM- 09-2441-18 18mm



Rust
 FM- 09-2442-39
 39 cm/15 3/4"





Charriere
 FM- 09-2443-27 27 cm/11"
 FM- 09-2443-30 30 cm/12"
 FM- 09-2443-34 33 cm/13"



Satterlee
 FM- 09-2444-31
 31 cm/12 1/2"



Charriere
 FM- 09-2445-27 27 cm/11"
 FM- 09-2445-30 30 cm/12"



Satterlee
 FM- 09-2446-31
 31 cm/12 1/2"



FM- 09-2447-23
 23 cm/9"

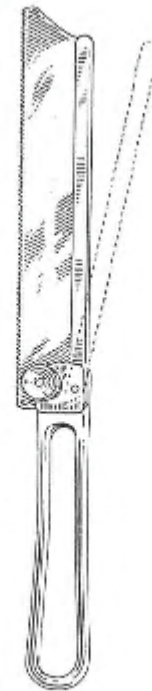

FM- 09-2448-19
 19 cm/7 1/2"

EN Flat Nose Pliers, Wire Cutting Pliers, Seizing Forceps
 DE Flachzangen, Draht-kheifzangen, Faßzangen
 ES Alicates planos, alicates para cortar alambre
 FR Pincès à becs plats, pincès coupantes, pincès à griffes
 IT Pinze a becchi piatti, pinze taglia li, pinze di presa

BONE SURGERY



FM- 09-2486-16
 16.5 cm/6 1/2"

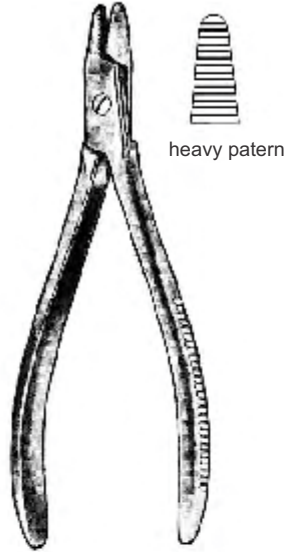

FM- 09-2487-16
 16 cm/6 1/2"



FM- 09-2488-15
 15 cm/6"



FM- 09-2489-17
 17 cm/6 3/4"



FM- 09-2490-18
 18 cm/7"



FM- 09-2491-18
 18 cm/7"

Flat Nose Pliers EN
 Flachzangen DE
 Alicates planas ES
 Pinces à bec plat FR
 Pinza a becchi piatti IT

09



FAIZAN & MUSA
 SPECIAL INSTRUMENTS

BONE SURGERY



17 cm/6 3/4"



FM- 09-2492-17



FM- 09-2493-17



18 cm/7"



FM- 09-2494-18



FM- 09-2495-18



FM- 09-2496-18

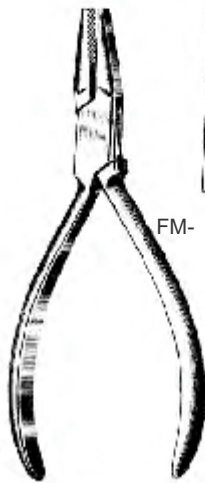
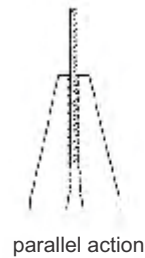

14 cm/5 1/2"



FM- 09-2497-14



FM- 09-2498-14



FM- 09-2499-16
 16 cm/6 1/4"



FM- 09-2500-19
 19.5 cm/7 3/4"



**PARHAM**

FM- 09-2501-18 18 cm/7"
 FM- 09-2501-20 20 cm/8"
 FM- 09-2501-25 25 cm/10"
 FM- 09-2501-30 30 cm/12"

**PARHAM**

FM- 09-2502-22
 22 cm/9 ¼"

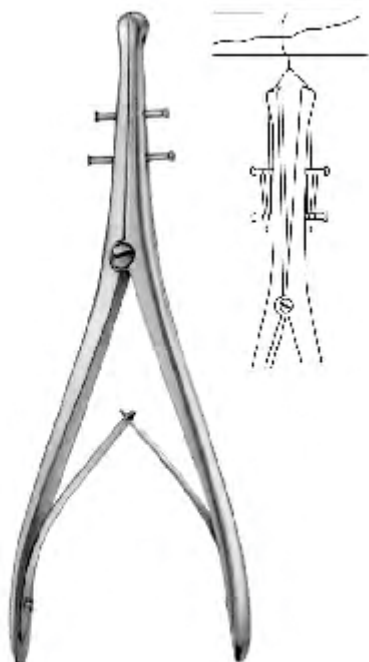
**DEMEL**

FM- 09-2503-28
 28 cm/11"

**LOUTE**

FM- 09-2504-21
 21 cm/8 ¼"

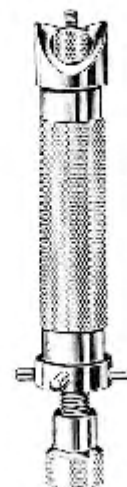
**LLOYD**

FM- 09-2505-00

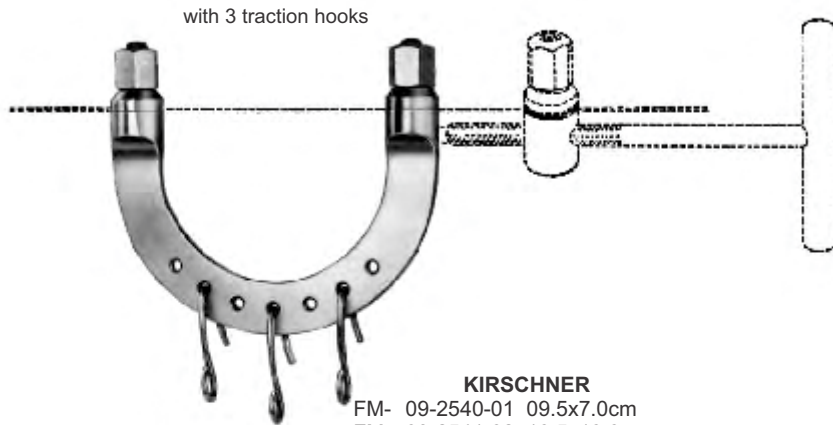

KIRSCHNER

- FM- 09-2540-01 09.5x7.0cm
- FM- 09-2541-02 10.5x10.0cm
- FM- 09-2542-03 12.0x12.0cm
- FM- 09-2543-04 15.5x15.5cm
- FM- 09-2544-05 20.0x15.5cm



KIRSCHNER

- FM- 09-2545-01 6.0x6.0cm

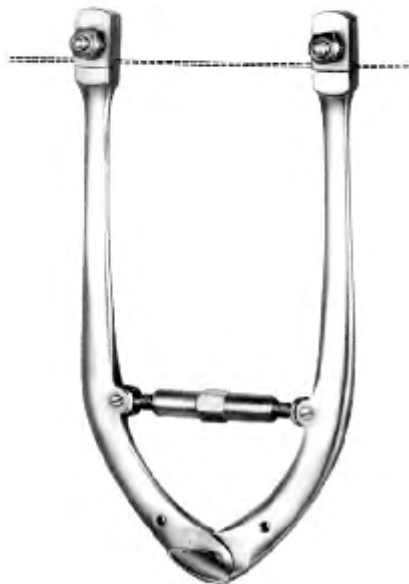

- FM- 09-2546-18 18.0x10.0cm
- FM- 09-2546-27 27.0x27.0cm



- FM- 09-2547-18



- FM- 09-2548-19 19.0cm

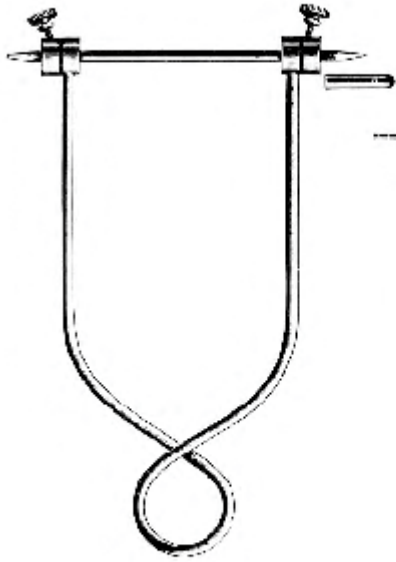

- FM- 09-2549-03
- FM- 09-2550-06

**BÖHLER**

FM- 09-2551-15 21.0x15.0cm
 FM- 09-2551-16 16.0x 9.0cm
 FM- 09-2551-21 21.0x11.0cm

**KIRSCHNER**

FM- 09-2552-13 13.5cm, infant
 FM- 09-2552-18 18.5cm, child
 FM- 09-2552-27 27.0cm, adult

**MARTIN-DIAMANT**

FM- 09-2553-16
 16 cm/6 1/4"



FM- 09-2554-16
 16 cm/6 1/4"



FM- 09-2555-15
 15 cm/6"



FM- 09-2556-23
 23 cm/9"



FM- 09-2556-25
 25 cm/10"



FM- 09-2557-24
 24 cm/9 1/4"

Bone Curettes **EN**
 Scharfe Löffel **DE**
 Cucharillas cortantes **ES**
 Curettes osseuses **FR**
 Curette d'ossa **IT**

09



BONE SURGERY



0000 FM- 09-2568-40 000 FM- 09-2568-30 00 FM- 09-2568-20

0 FM- 09-2568-10 1 FM- 09-2568-01 2 FM- 09-2568-02

3 FM- 09-2568-03 4 FM- 09-2568-04

5 FM- 09-2568-05 6 FM- 09-2568-06

VOLKMANN
17 cm/7"



0000 FM- 09-2569-40 000 FM- 09-2569-30 00 FM- 09-2569-20

0 FM- 09-2569-10 1 FM- 09-2569-01 2 FM- 09-2569-02

3 FM- 09-2569-03 4 FM- 09-2569-04

5 FM- 09-2569-05 6 FM- 09-2569-06

BRUNS
17 cm/7"



000 FM- 09-2570-30 00 FM- 09-2570-20 0 FM- 09-2570-10

1 FM- 09-2570-01 2 FM- 09-2570-02

3 FM- 09-2570-03 4 FM- 09-2570-04

SCHEDE
17 cm/7"



0000 FM- 09-2571-40 000 FM- 09-2571-30 00 FM- 09-2571-20

0 FM- 09-2571-10 1 FM- 09-2571-01

2 FM- 09-2571-02 3 FM- 09-2571-03

4 FM- 09-2571-04 5 FM- 09-2571-05

SPRATT
16.5 cm/6 3/4"

EN	Bone Curettes
DE	Scharfe Löffel
ES	Cucharillas cortantes
FR	Curettes osseuses
IT	Curette d'ossa

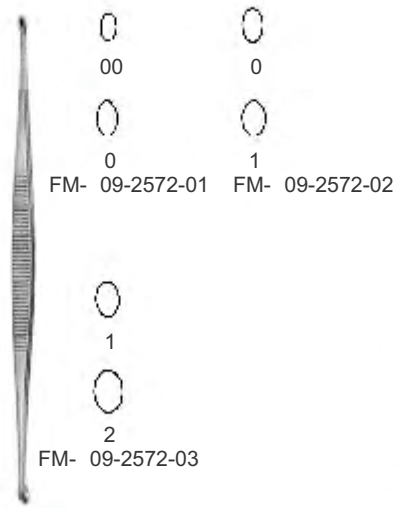

WILLIGER
13.5 cm/5 1/4"

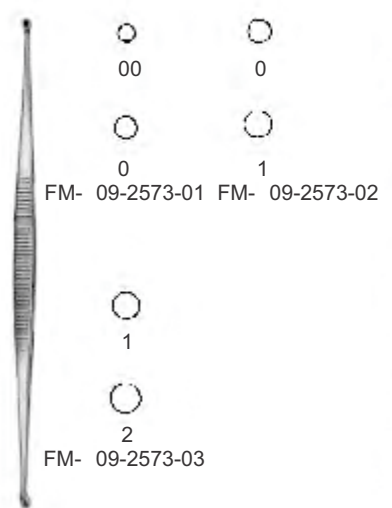

MARTINI
13.5 cm/5 1/4"

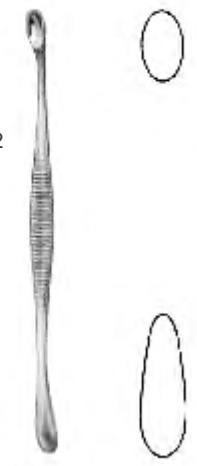

VOLKMANN
FM- 09-2574-13 13 cm/5"
FM- 09-2574-14 14 cm/5 1/2"
FM- 09-2574-17 17 cm/7"



VOLKMANN
FM- 09-2575-13 13 cm/5 1/4"
FM- 09-2575-16 16 cm/6 1/4"
FM- 09-2575-20 20 cm/8"



FM- 09-2576-21
21 cm/8 1/4"

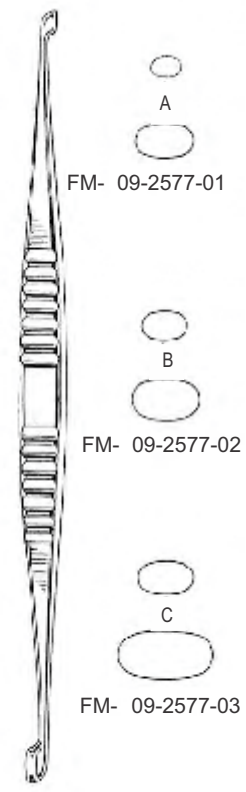

VOLKMANN
21.5 cm/8 1/2"

Bone Holding Forceps EN

Knochenhaltezangen DE

Pinzas para huesos ES

Forceps de maintien d'os FR

Pinze per la detenzione ossea IT

09



FAIZAN & MUSA
SPECIAL INSTRUMENTS

BONE SURGERY



Martin
FM- 09-2582-19
19 cm/7 1/2"



Preston
FM- 09-2583-18
18 cm/7 1/4"

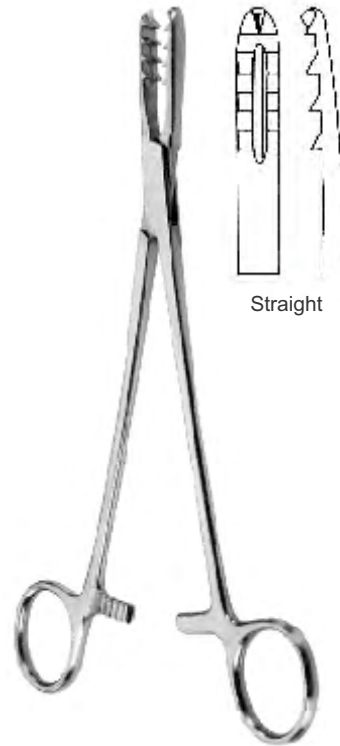

Bircher-Ganske
FM- 09-2584-20
20 cm/8"

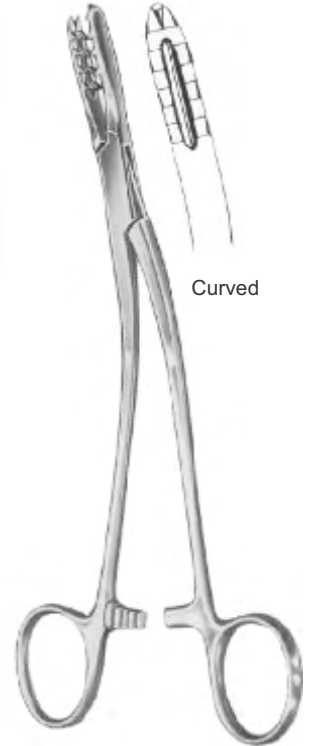

Bircher-Ganske
FM- 09-2585-20
20 cm/8"



Lewin
FM- 09-2586-17
17.5 cm/7"



Langenbeck
FM- 09-2587-21
21 cm/8 1/4"



Fergusson
FM- 09-2588-21
21 cm/8 1/4"

EN	Bone Holding Forceps
DE	Knochenhaltezangen
ES	Pinzas para huesos
FR	Forceps de maintien d'os
IT	Pinze per la detenzione ossea

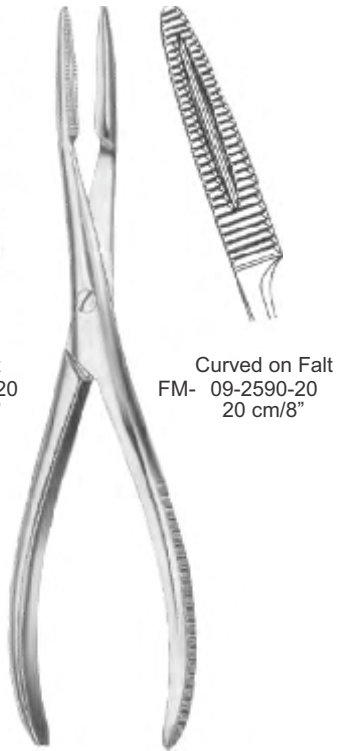

Bone Holding Forceps EN

Knochenhaltezaugen DE

Pinzas para huesos ES

Forceps de maintien d'os FR

Pinze per la detenzione ossea IT

09



FAIZAN & MUSA
SPECIAL INSTRUMENTS

BONE SURGERY



Semb
FM- 09-2595-19
19 cm/7½"



Semb
FM- 09-2596-19
19 cm/7½"



Verbrugge
FM- 09-2597-17
17.5 cm/7"

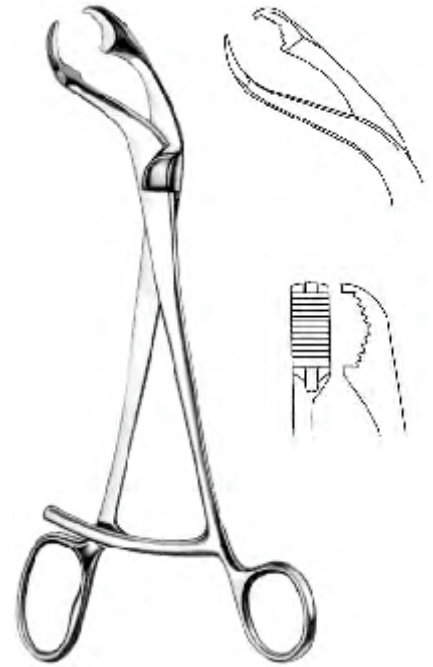

Verbrugge
FM- 09-2598-17
17.5 cm/7"

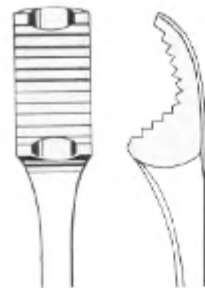

FM- 09-2599-25
25 cm/10"

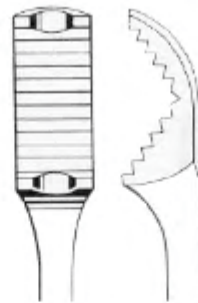

FM- 09-2599-26
26 cm/10¼"
Verbrugge

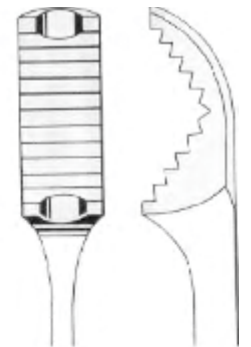

FM- 09-2599-27
27 cm/10½"

EN Bone Holding Forceps
 DE Knochenhaltezaugen
 ES Pinzas para huesos
 FR Forceps de maintien d'os
 IT Pinze per la detenzione ossea



FAIZAN & MUSA
 SPECIAL INSTRUMENTS

BONE SURGERY



FM- 09-2601-16
 16 cm/6¼"
 FM- 09-2601-24
 24 cm/9½"



Without Ratchet
 FM- 09-2602-17
 FM- 09-2602-21

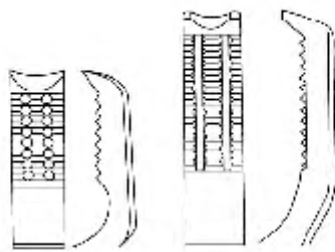

Kern
 cm in
 17 6¾"
 21 8¼"



With Ratchet
 FM- 09-2603-17
 FM- 09-2603-21

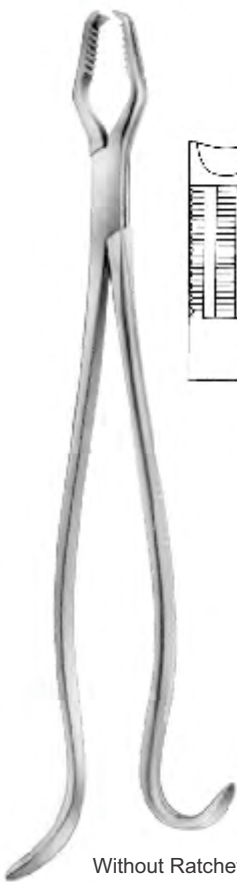
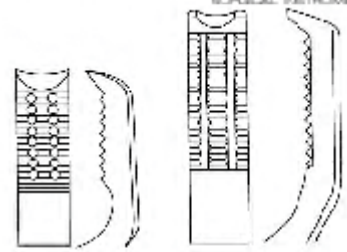

Without Ratchet
 FM- 09-2604-33
 FM- 09-2604-45

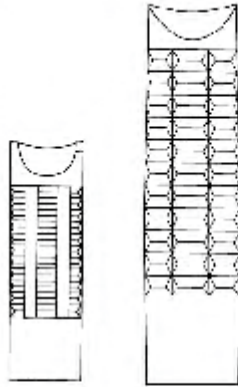

Lane
 cm in
 33 13"
 45 17¾"

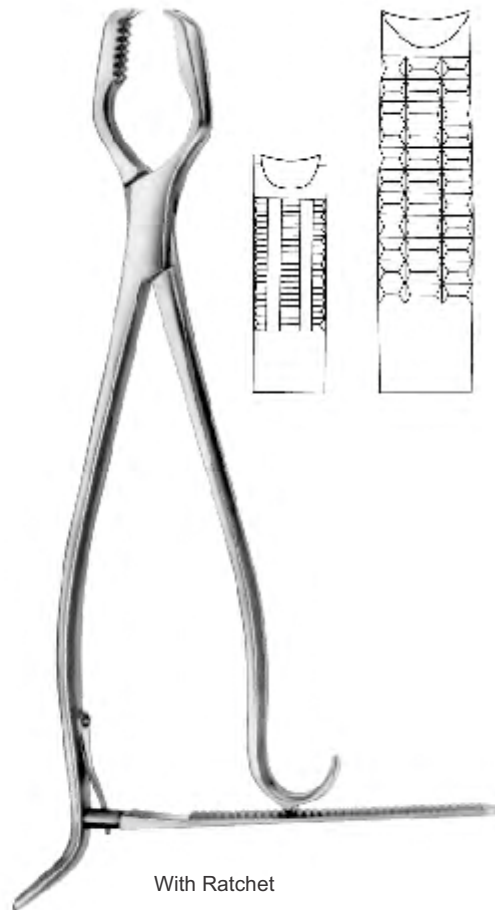

With Ratchet
 FM- 09-2605-33
 FM- 09-2605-45

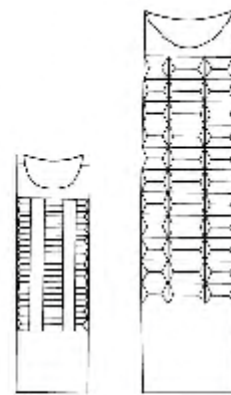

Bone Holding Forceps EN

Knochenhaltezangen DE

Pinzas para huesos ES

Forceps de maintien d'os FR

Pinze per la detenzione ossea IT

09



FAIZAN & MUSA
SPECIAL INSTRUMENTS

BONE SURGERY



ULRICH

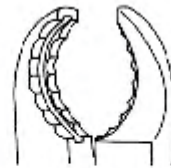
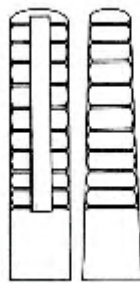

FM- 09-2606-23 23.0cm
FM- 09-2607-22 22.0cm



FM- 09-2606-25 25.0cm
FM- 09-2607-24 24.0cm



FM- 09-2606-28 28.0cm
FM- 09-2607-27 27.0cm



ULRICH

EN Bone Holding Forceps

DE Knochenhaltezangen

ES Pinzas para huesos

FR Forceps de maintien d'os

IT Pinze per la detenzione ossea



FM- 09-2608-19 19 cm/8 3/4"
FM- 09-2608-26 26 cm/10 1/4"



ULRICH
FM- 09-2608-28
28 cm/11"

Bone Holding Forceps EN

Knochenhaltezangen DE

Pinzas para huesos ES

Forceps de maintien d'os FR

Pinze per la detenzione ossea IT

09



FAIZAN & MUSA
SPECIAL INSTRUMENTS

BONE SURGERY



Farabeuf-Lambotte
FM- 09-2609-26
26 cm/10 1/4"



Lambotte
FM- 09-2610-19 19 cm/7 1/2"
FM- 09-2610-23 23 cm/9"
FM- 09-2610-26 26 cm/10 1/4"



FM- 09-2611-13
13.5 cm/5 1/4"



Bruns
FM- 09-2611-18
18.5 cm/7 1/4"



FM- 09-2611-14
14.5 cm/5 3/4"



FM- 09-2612-12
12 cm/4 3/4"



FM- 09-2612-21
21 cm/8 1/4"



FM- 09-2612-14
14 cm/5 1/2"

EN	Bone Holding Forceps
DE	Knochenhaltezaugen
ES	Pinzas para huesos
FR	Forceps de maintien d'os
IT	Pinze per la detenzione ossea



- FM- 09-2613-15 15 cm/6"
- FM- 09-2613-19 19 cm/7 1/2"
- FM- 09-2613-24 24 cm/9 1/2"
- FM- 09-2613-26 26 cm/10 1/4"
- FM- 09-2613-28 28 cm/11"



Handles Detachable

Percy
FM- 09-2614-30

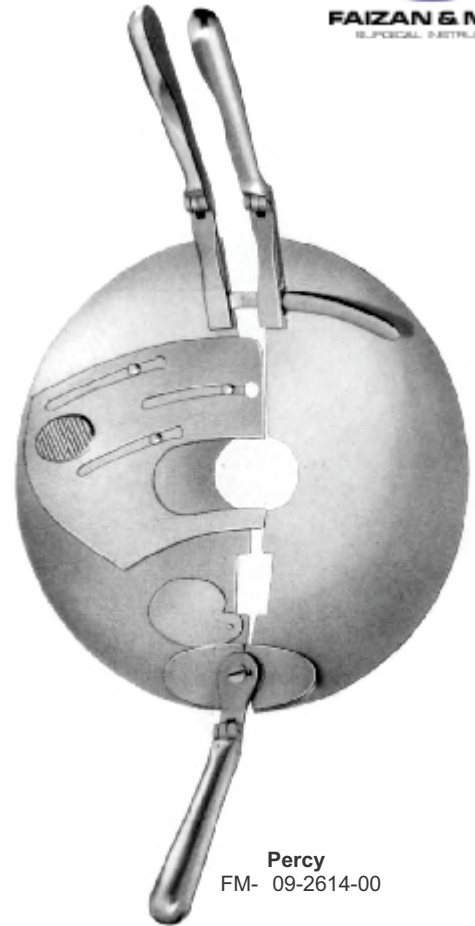

Percy
FM- 09-2614-00



Adjustable

- Lambotte**
- FM- 09-2615-22 22 cm/8 3/4"
 - FM- 09-2615-27 27 cm/10 1/2"
 - FM- 09-2615-30 30 cm/12"



- Farabeuf**
- FM- 09-2616-23 23 cm/9"
 - FM- 09-2616-26 26 cm/10 1/4"



- Lambotte**
- FM- 09-2617-22 22.5 cm/9"
 - FM- 09-2617-25 25.5 cm/10 1/2"
 - FM- 09-2617-33 33 cm/13 1/2"



- Haase**
- FM- 09-2617-16 16.5 cm/6 1/2"

Bone Holding Forceps EN

Knochenhaltezaugen DE

Pinzas para huesos ES

Forceps de maintien d'os FR

Pinze per la detenzione ossea IT

09



FAIZAN & MUSA
SPECIAL INSTRUMENTS

BONE SURGERY



LOWMAN

FM- 09-2633-12 12.0cm
FM- 09-2633-18 18.5cm
FM- 09-2633-20 20.0cm
FM- 09-2633-22 22.0cm

GERSTER-LOWMANN

FM- 09-2634-18 18.0cm
FM- 09-2634-20 20.0cm
FM- 09-2634-22 22.0cm

LAMBERT-LOWMAN

2x2 prongs
FM- 09-2635-18 18.0cm
FM- 09-2635-20 20.0cm
FM- 09-2635-22 22.0cm

LOWMAN-HOGLUND

FM- 09-2636-12 12.0cm
FM- 09-2636-17 17.5cm
FM- 09-2636-20 20.0cm
FM- 09-2636-22 22.0cm

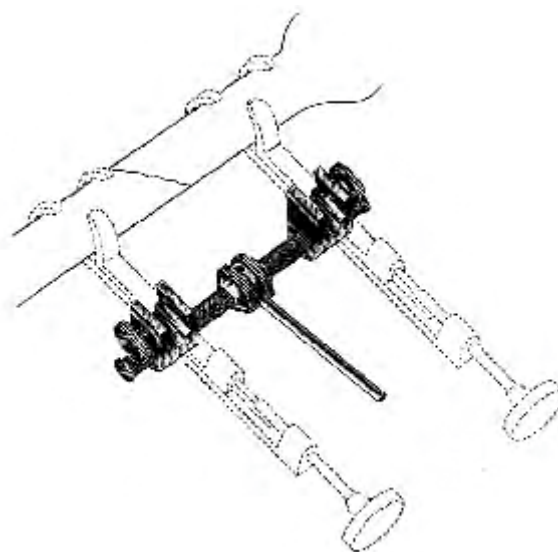

GERSTER

FM- 09-2637-15

EN	Bone Rongeur Forceps
DE	Hohlmeißelzangen
ES	Pinzas-gubias
FR	Bone Rongeur Forceps
IT	Bone Rodent Forceps

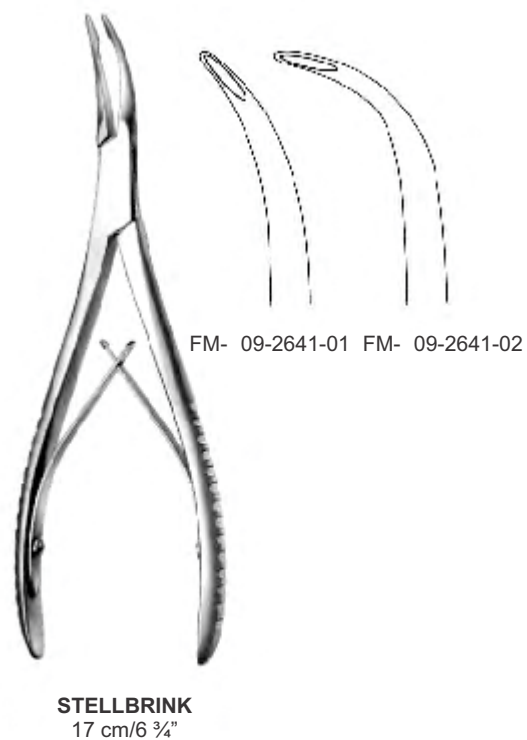



MINI-FRIEDMAN
FM- 09-2643-12
12 cm/4 ¾"



FRIEDMAN
FM- 09-2644-14
14 cm/5 ½"



MEAD
FM- 09-2645-16
16.5 cm/6 ½"



MEAD
FM- 09-2646-16
16.5 cm/6 ½"



HARTMANN
FM- 09-2647-16
16 cm/6 ¼"



HARTMANN
FM- 09-2648-18
18.5 cm/7 ¼"

EN	Bone Rongeur Forceps
DE	Hohlmeißelzangen
ES	Pinzas-gubias
FR	Bone Rongeur Forceps
IT	Bone Rodent Forceps

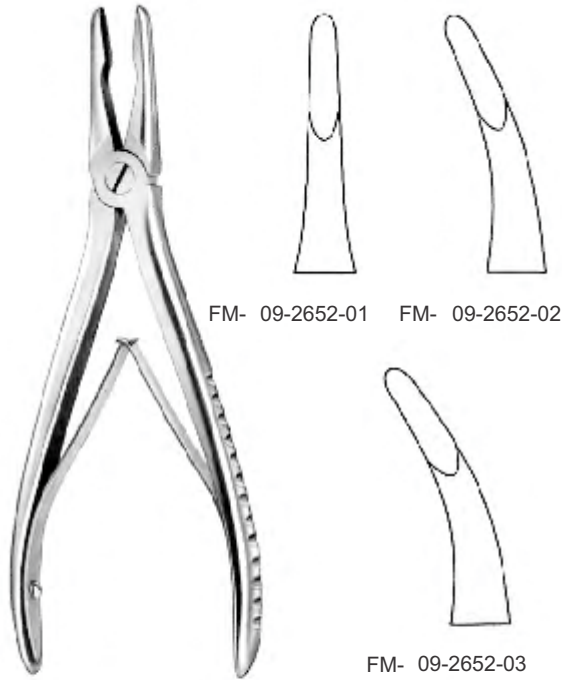

JANSEN
18 cm/7"

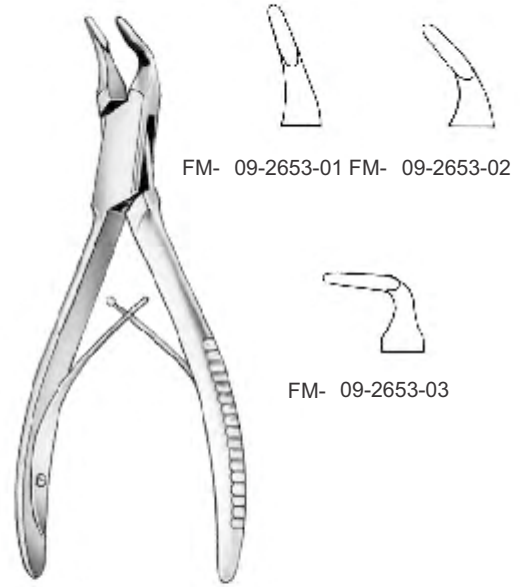

BLUMENTHAL
15 cm/6"



LEMPERT
20 cm/8"

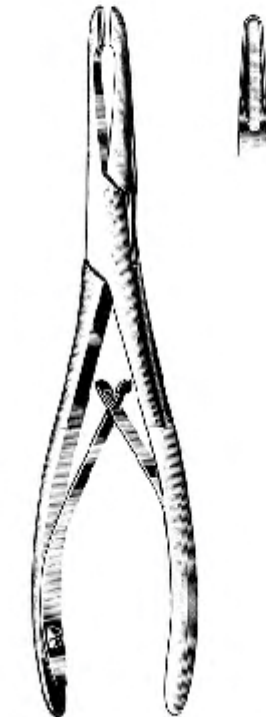

DEFOURMENTEL
FM- 09-2656-19
19 cm/7 3/4"



LUER
FM- 09-2661-01
15 cm/6"



LUER
FM- 09-2661-02
15 cm/6"

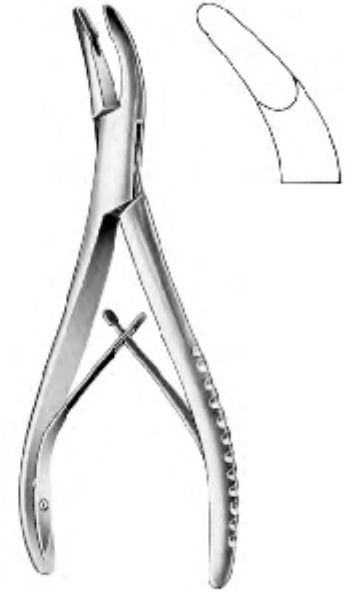

LUER
FM- 09-2661-03
15 cm/6"



LUER
FM- 09-2662-01
15 cm/6"



LUER
FM- 09-2662-02
15 cm/6"

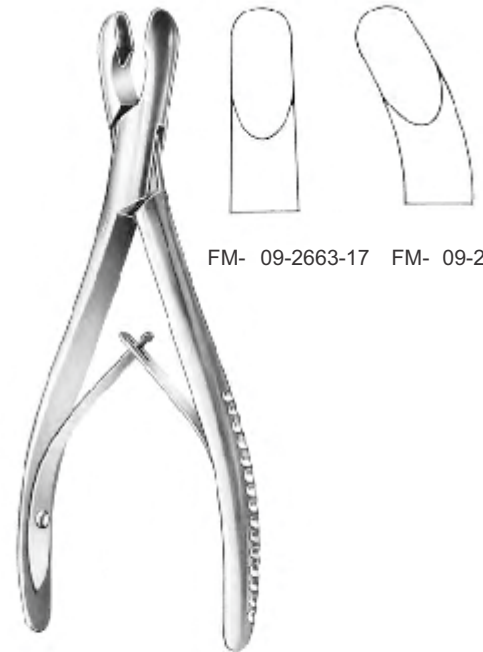

FM- 09-2663-17 FM- 09-2664-17

LUER
17 cm/6 3/4"

EN	Bone Rongeur Forceps
DE	Hohlmeißelzangen
ES	Pinzas-gubias
FR	Bone Rongeur Forceps
IT	Bone Rodent Forceps

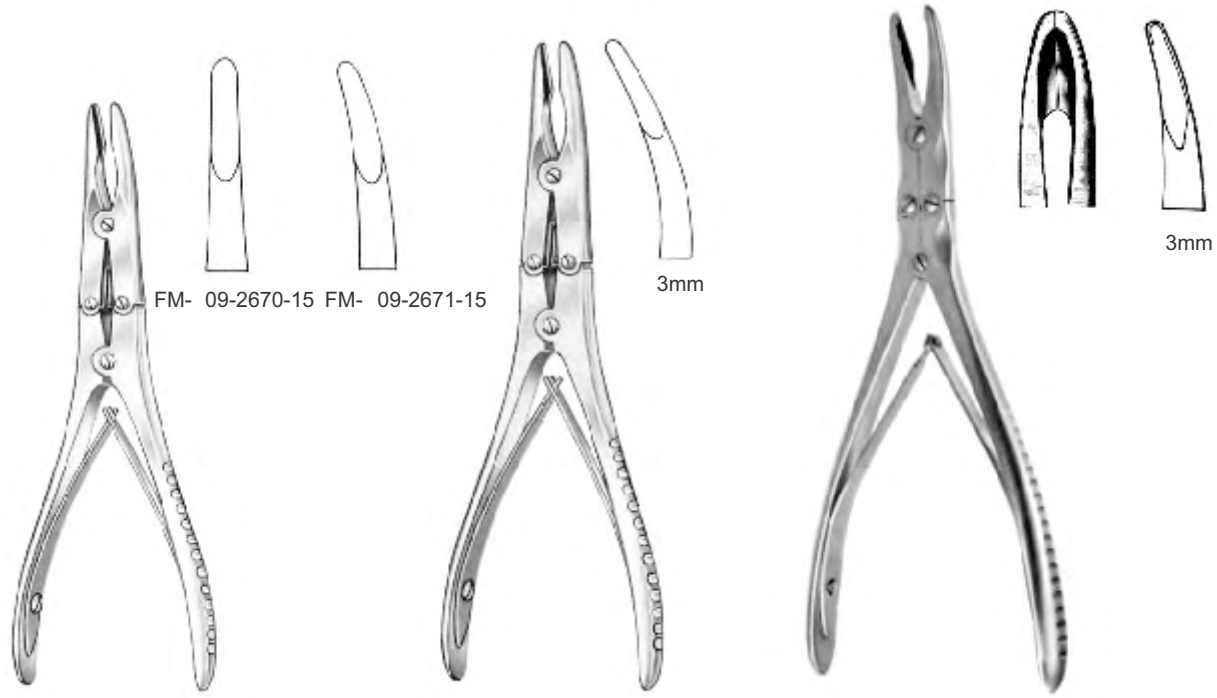

BÖHLER
15 cm/6"

KLEINERT-KUTZ
FM- 09-2672-15
15 cm/6"

GEIGER
FM- 09-2673-15
15 cm/6"

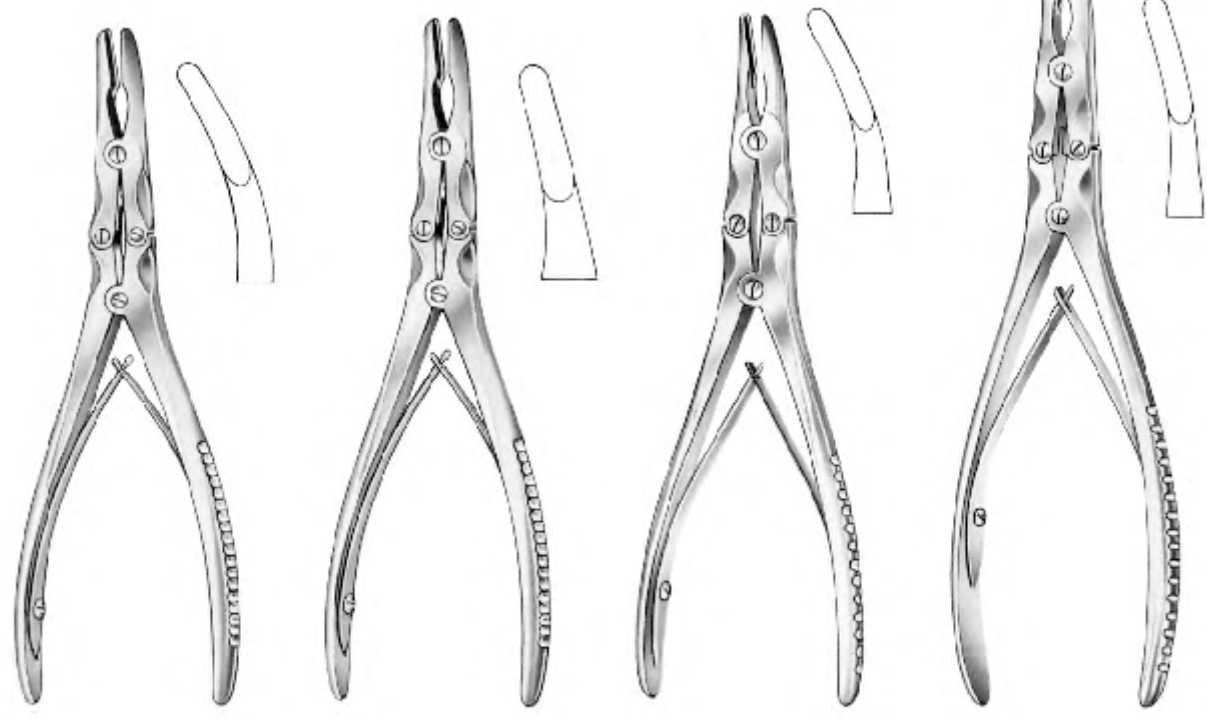

BEYER
FM- 09-2674-18
18 cm/7"

ZAUFAL-JANSEN
FM- 09-2675-18
18 cm/7"

MAYFIELD
FM- 09-2676-17
17 cm/6 3/4"

MARQUARDT
FM- 09-2677-20
20 cm/8"

Bone Rongeur Forceps **EN**
 Hohlmeißelzangen **DE**
 Pinzas-gubias **ES**
 Bone Rongeur Forceps **FR**
 Bone Rodent Forceps **IT**

09



FAIZAN & MUSA
 SURGICAL INSTRUMENTS

BONE SURGERY



RUSKIN-MINI
 15 cm/6"

FM- 09-2678-02 2mm
 FM- 09-2678-03 3mm



RUSKIN-MINI
 15 cm/6"

FM- 09-2679-02 2mm
 FM- 09-2679-03 3mm



PEIPER-BEYER
 FM- 09-2680-18
 18 cm/7"

4mm



RUSKIN
 FM- 09-2681-18
 18 cm/7"



5mm

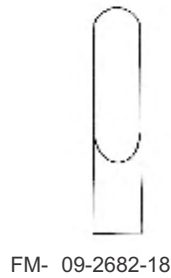

FM- 09-2682-18



RUSKIN
 18 cm/7"



FM- 09-2683-18

FM- 09-2684-23



RUSKIN
 23 cm/9"



FM- 09-2685-23

EN	Bone Cutting Forceps
DE	Knochensplitterzangen
ES	Pinzas cortantes para huesos
FR	Forceps de coupe osseuse
IT	Pinze per taglio osseo



FM- 09-2686-12
12 cm/5"

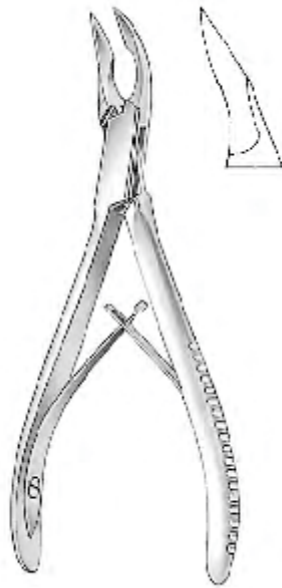

CLEVELAND
FM- 09-2687-15
15 cm/6"



CLEVELAND
FM- 09-2688-17
17 cm/6 3/4"

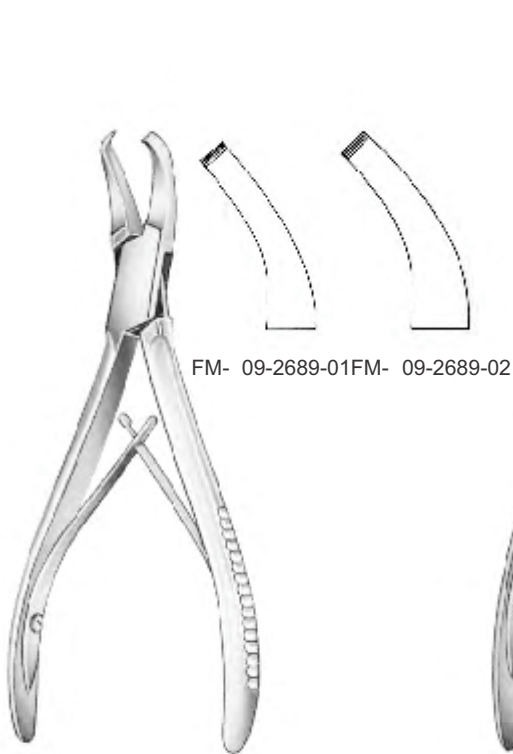

CLEVELAND
16 cm/6 1/2"

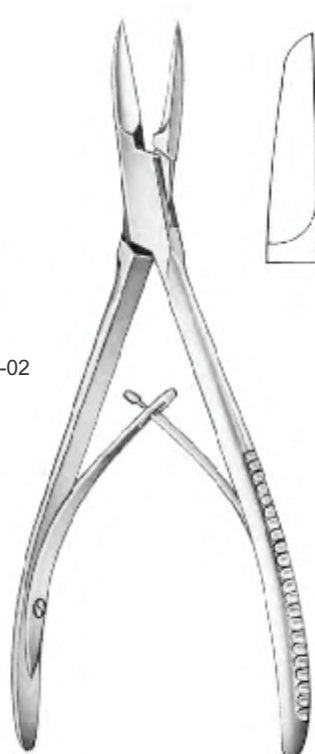

COTTLE-KAZANJIAN
FM- 09-2690-19
19 cm/7 3/4"



MARKWALDER
FM- 09-2691-20
20 cm/8"

Bone Cutting Forceps EN

Knochensplitterzangen DE

Pinzas cortantes para huesos ES

Forceps de coupe osseuse FR

Pinze per taglio osseo IT

09



FAIZAN & MUSA
SPECIAL INSTRUMENTS

BONE SURGERY



LISTON

- FM- 09-2692-14 14.0cm 09-2693-14
- FM- 09-2692-17 17.0cm 09-2693-17
- FM- 09-2692-19 19.0cm 09-2693-19
- FM- 09-2692-22 22.0cm 09-2693-22



MC INDOE

- FM- 09-2694-17 17.5 cm/7"



Bouier

- FM- 09-2695-15 15 cm/6"



FM- 09-2696-15



FM- 09-2697-15

15 cm/6"

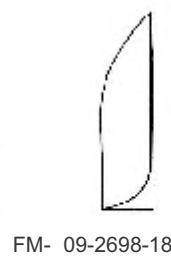

FM- 09-2698-18



RUSKIN-LISTON

18.5 cm/7 1/2"



FM- 09-2699-18

EN Bone Cutting Forceps

DE Knochensplitterzangen

ES Pinzas cortantes para huesos

FR Forceps de coupe osseuse

IT Pinze per taglio osseo

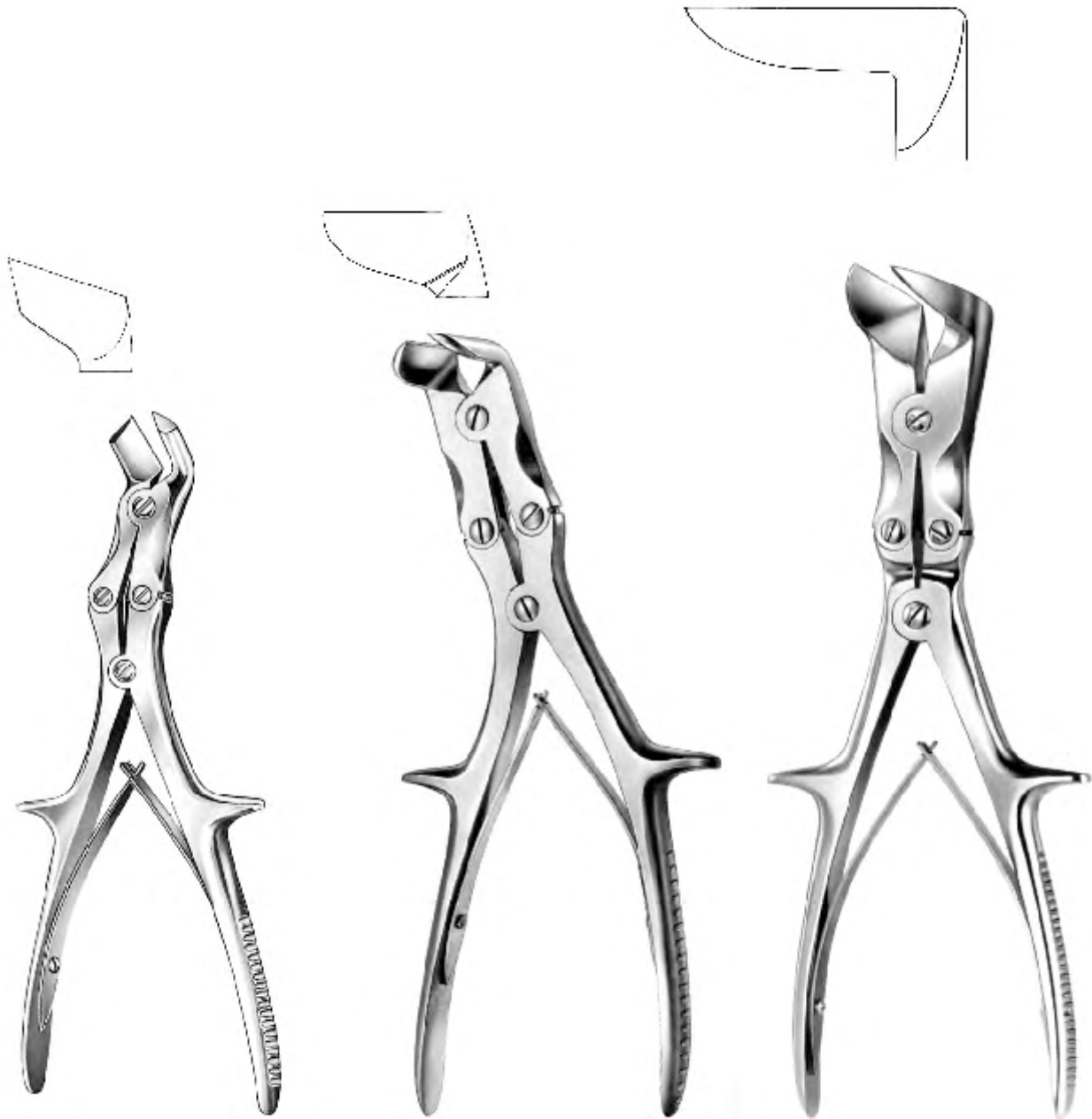
FAIZAN & MUSA
SPECIAL INSTRUMENTS

TUDOR-EDWARDS
FM- 09-2700-23
23 cm/9"

SEMB
FM- 09-2701-24
24 cm/9 3/4"

STILLE-LISTON
FM- 09-2702-27
27 cm/10 3/4"

Bone Cutting Forceps EN

Knochensplitterzangen DE

Pinzas cortantes para huesos ES

Forceps de coupe osseuse FR

Pinze per taglio osseo IT

09



FAIZAN & MUSA
SPECIAL INSTRUMENTS

BONE SURGERY

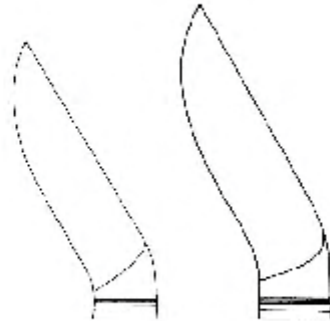

09-2704-23

09-2704-27



STILLE LISTON
FM- 09-2703-27
27 cm/10 3/4"



STILLE LISTON
FM- 09-2704-23 23 cm/9"
FM- 09-2704-27 27 cm/10 3/4"



LISTON KEY
FM- 09-2705-27
27 cm/10 3/4"

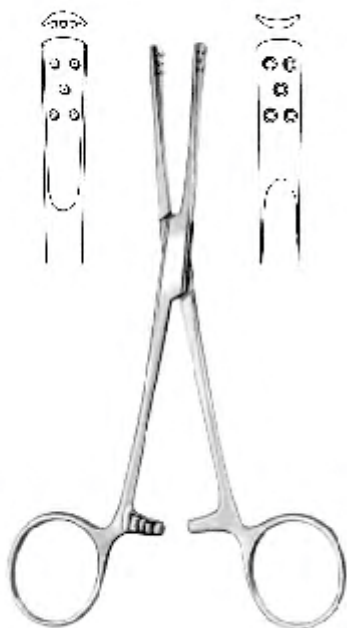

PENNER
 FM- 09-2706-15
 15 cm/6"



RADOLF
 FM- 09-2707-13
 13.5 cm/5 1/2"



FM- 09-2708-01 saw
 FM- 09-2708-02 key

FM- 09-2708-00
 17 cm/7"



FM- 09-2709-01 saw
 FM- 09-2709-02 key

FM- 09-2709-00
 17 cm/7"



FM- 09-2710-01 saw
 FM- 09-2710-02 key

WALTON
 FM- 09-2710-00
 16 cm/5 1/2"



FM- 09-2711-01 saw
 FM- 09-2711-02 key

FM- 09-2711-00

EN Plaster Instruments

Page 115 to 117

DE Plaster Instrumente

ES Instrumentos de yeso

FR Plâtre

IT Strumenti in gesso



EN Bandage Scissors

DE Verbandschere

ES Tijeras vendaje

FR Ciseaux de pansement

IT Forbici per bende

FAIZAN & MUSA
SPECIAL INSTRUMENTS**Lister**

- FM- 10-2801-09 09.0 cm/3 1/2"
- FM- 10-2801-11 11.5 cm/4 1/2"
- FM- 10-2801-14 14.0 cm/5 1/2"
- FM- 10-2801-15 15.5 cm/6"
- FM- 10-2801-18 18.0 cm/7"
- FM- 10-2801-20 20.0 cm/8"

**Lister**

- FM- 10-2802-18 18.5 cm/7 1/4"
- FM- 10-2802-21 21.0 cm/8 1/4"

**Lister-Excentric**

- FM- 10-2803-16 16 cm/6 1/4"
- FM- 10-2803-19 19 cm/7 1/2"

**Esmarch**

- FM- 10-2804-20 20 cm/8"
- FM- 10-2804-22 22 cm/8 1/2"

**Bergmann**

- FM- 10-2805-23 23 cm/9"

**Lorenz**

- FM- 10-2806-23 23 cm/9"



Bergmann
 FM- 10-2821-18
 18 cm/7"



Engel
 FM- 10-2822-14
 14 cm/5 1/2"

Plaster of paris knives and saws



Hopkins
 FM- 10-2823-20
 20 cm/8"



Esmarch
 FM- 10-2824-18
 18 cm/7"



Reiner
 FM- 10-2825-18
 18 cm/7"



FM- 10-2826-21
 21 cm/8 1/2"



Wigmore
 FM- 10-2827-19
 19 cm/7 1/2"

EN	Plaster shears
DE	Gipsscheren
ES	Tijeras para yeso
FR	Cisailles à plâtre
IT	Cesoie per gesso

PALSTER



FM- 10-2828-20 20.0cm



Seutin
FM- 10-2829-23 23.0cm



Bruns
FM- 10-2830-24 24.0cm



Bruns (serrated)
FM- 10-2831-24 24.0cm



Stille-Mini
FM- 10-2832-20 20.0cm



Stille
FM- 10-2833-20 20.0cm
FM- 10-2833-23 23.0cm
FM- 10-2833-26 26.0cm
FM- 10-2833-30 30.0cm
FM- 10-2833-37 37.0cm



Stille
FM- 10-2834-24 24.0cm



FAIZAN & MUSA
SPECIAL INSTRUMENTS

EN	Suture
DE	Naht
ES	Sutura
FR	Suture
IT	Suturare

Page 118 to 136



EN	Needle Holders
DE	Nadelhalter
ES	Pinzas hemostáticas
FR	Porte-aiguilles
IT	Porta-ago

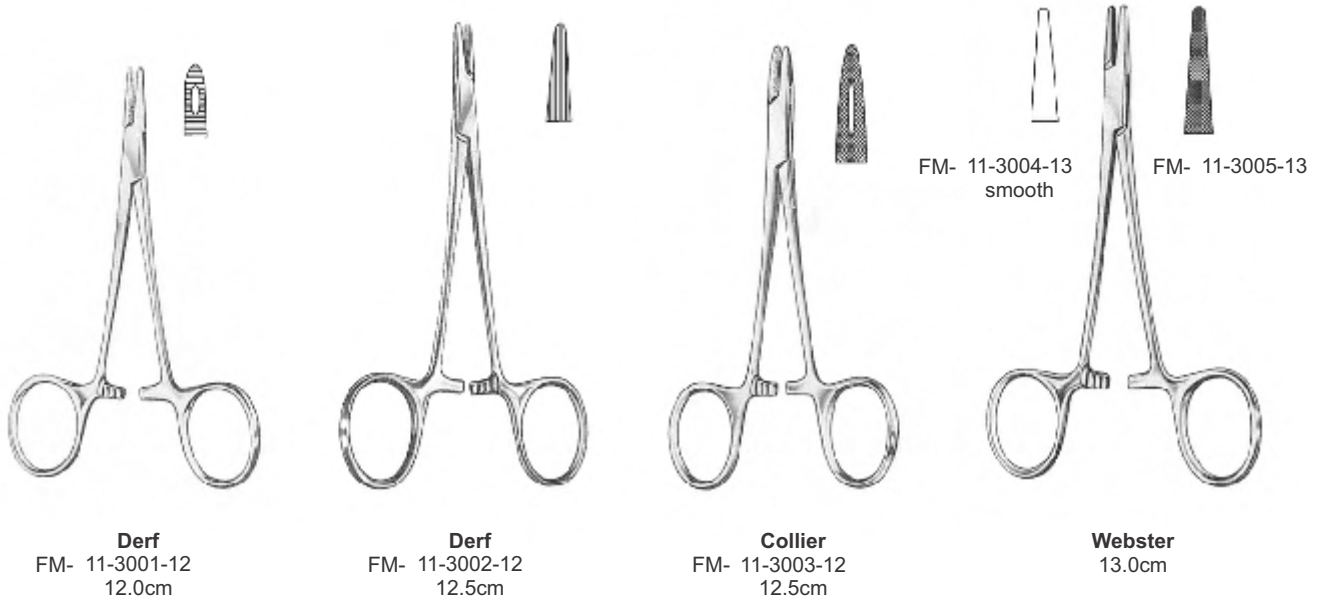

Nadelhalter

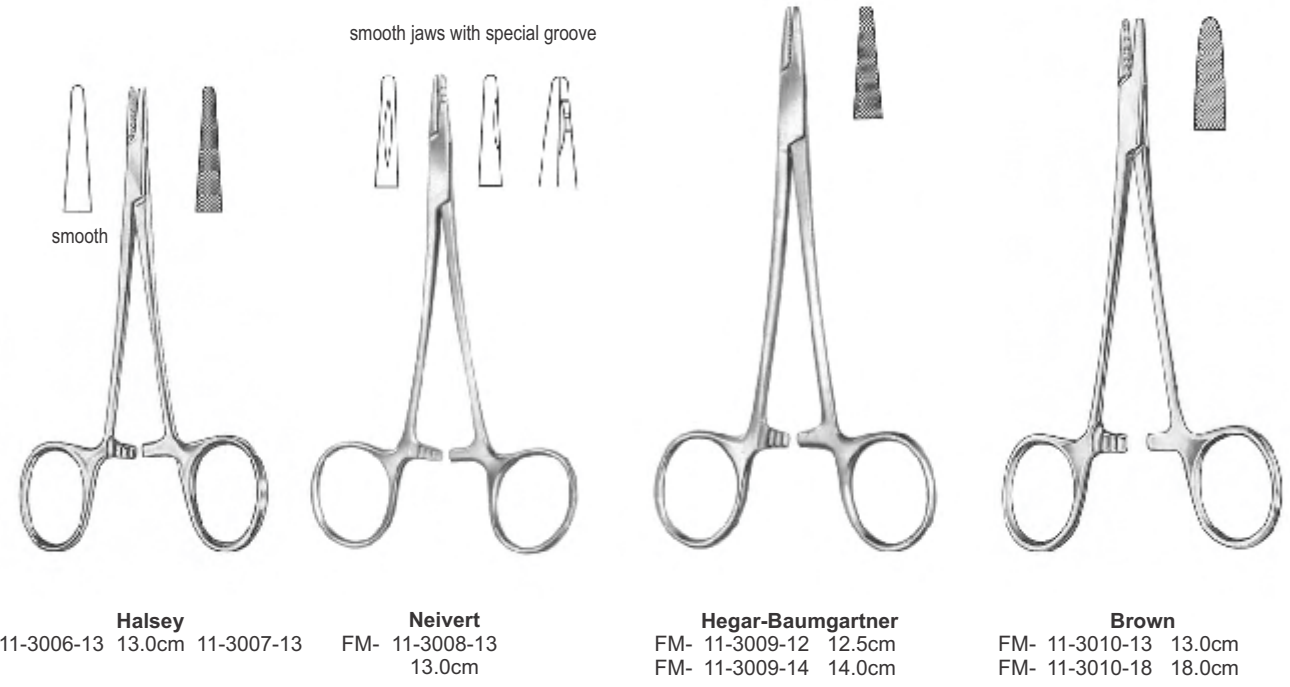



Mayo-Hegar

- | | | |
|----------------|--------|------------|
| FM- 11-3011-14 | 14.0cm | 11-3012-14 |
| FM- 11-3011-15 | 15.0cm | 11-3012-15 |
| FM- 11-3011-16 | 16.0cm | 11-3012-16 |
| FM- 11-3011-18 | 18.0cm | 11-3012-18 |
| FM- 11-3011-20 | 20.0cm | 11-3012-20 |
| FM- 11-3011-22 | 22.0cm | 11-3012-22 |
| FM- 11-3011-24 | 24.0cm | 11-3012-24 |
| FM- 11-3011-26 | 26.0cm | 11-3012-26 |
| FM- 11-3011-28 | 28.0cm | 11-3012-28 |
| FM- 11-3011-30 | 30.0cm | 11-3012-30 |



delicate pattern

Mayo-Hegar

- | | |
|----------------|--------|
| FM- 11-3013-16 | 16.0cm |
| FM- 11-3013-18 | 18.0cm |
| FM- 11-3013-20 | 20.0cm |



Crile-Murray

- | | |
|----------------|--------|
| FM- 11-3014-15 | 15.0cm |
|----------------|--------|



Crile-Wood

- | | |
|----------------|--------|
| FM- 11-3015-15 | 15.0cm |
| FM- 11-3015-18 | 18.0cm |
| FM- 11-3015-20 | 20.0cm |



Hegar

- | | | |
|----------------|--------|------------|
| FM- 11-3016-20 | 20.0cm | 11-3017-20 |
| FM- 11-3016-24 | 24.0cm | 11-3017-24 |



Adson

- | | |
|----------------|--------|
| FM- 11-3018-18 | 18.0cm |
|----------------|--------|



Heaney

- | | |
|----------------|--------|
| FM- 11-3019-21 | 21.0cm |
|----------------|--------|



Metzenbaum

- | | |
|----------------|--------|
| FM- 11-3020-18 | 18.0cm |
|----------------|--------|

EN	Needle Holders
DE	Nadelhalter
ES	Pinzas hemostáticas
FR	Porte-aiguilles
IT	Porta-ago



Masson-Luethy
FM- 11-3021-26
26.0cm



Sarot
FM- 11-3022-18 18.0cm
FM- 11-3022-26 26.0cm



Wertheim
FM- 11-3023-20 20.0cm
FM- 11-3023-24 24.0cm



Stratte
FM- 11-3024-23
23.0cm



Bruce-Clarke
FM- 11-3025-12
12.5cm



Kilner
FM- 11-3026-13 13.5cm
FM- 11-3026-16 16.5cm



Thomson-Walker
FM- 11-3027-20
20.0cm

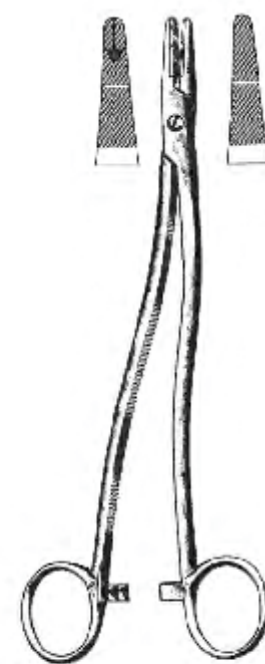

Bozemann
FM- 11-3028-20 20.0cm
FM- 11-3028-24 24.0cm



Wangensten
 FM- 11-3033-27
 27.0cm



Jamison
 FM- 11-3034-23
 23.5cm

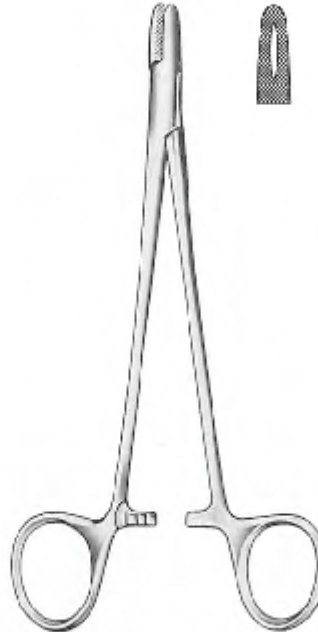

M.G.H.(mass-general-hospital)
 FM- 11-3035-17
 17.0cm



Gillies
 FM- 11-3036-16 16.0cm (right hand)
 FM- 11-3036-17 16.0cm (left hand)

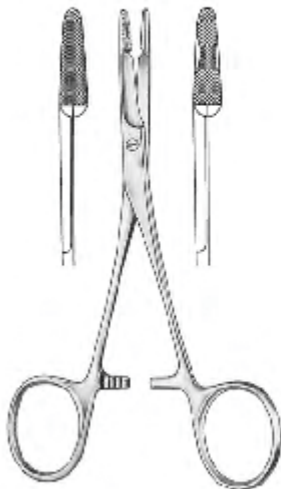

Olsen-Hegar
 FM- 11-3037-14 14.0cm 11-3038-14
 with blood groove



Olsen-Hegar
 FM- 11-3039-17
 17.0cm

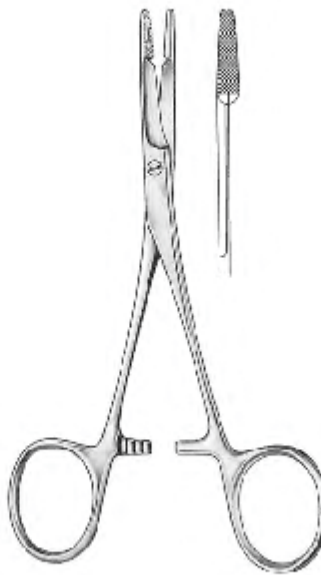

Olsen-Hegar
 FM- 11-3040-17
 17.0cm



Olsen-Hegar
 FM- 11-3041-14 14.0cm
 FM- 11-3041-18 18.0cm

EN	Needle Holders
DE	Nadelhalter
ES	Porta-agujas
FR	Porte-aiguilles
IT	Porta-agoi



Crile
FM- 11-3042-15 15.0cm



Toennis
FM- 11-3043-18 18.0cm



Lichtenberg
FM- 11-3044-20 20.0cm



Macphail
FM- 11-3045-14 14.0cm
FM- 11-3045-16 16.0cm
FM- 11-3045-18 18.0cm
FM- 11-3045-20 20.0cm



Mathieu
FM- 11-3046-14 14.0cm 11-3047-14
FM- 11-3046-17 17.0cm 11-3047-17
FM- 11-3046-20 20.0cm 11-3047-20
FM- 11-3046-24 24.0cm 11-3047-24



Mathieu
FM- 11-3048-14 14.0cm
FM- 11-3048-17 17.0cm



Mathieu
FM- 11-3049-17 17.0cm
FM- 11-3049-20 20.0cm

Delicate



BARRAQUER
 FM- 11-3050-16 16.0cm



ARRUGA
 FM- 11-3051-14 14.0cm
 FM- 11-3052-14 14.0cm



KALT
 FM- 11-3053-14 14.0cm



KALT-ARRUGA
 FM- 11-3054-14 14.0cm



CASTROVIEJO-KALT
 FM- 11-3055-13 13.5cm



BOYNTON
 FM- 11-3056-12 12.0cm



ARRUGA
 FM- 11-3057-16 16.0cm
 FM- 11-3058-16 16.0cm



STEVENSON
 FM- 11-3059-11 11.0cm



STEVENS
 FM- 11-3060-13 13.0cm
 FM- 11-3060-15 15.0cm



WECKER
 FM- 11-3061-15 15.0cm



BARRAQUER
 FM- 11-3062-14 14.0cm

EN	Micro Needle Holders
DE	Mikro Nadelhalter
ES	Micro-porta-agujas
FR	Porte-aiguilles micro
IT	Porta microaghi



CASTROVIEJO
FM- 11-3077-14 14.0cm
FM- 11-3077-17 17.0cm



CASTROVIEJO
FM- 11-3078-14 14.0cm
FM- 11-3078-17 17.0cm



CASTROVIEJO
FM- 11-3079-14 14.0cm
FM- 11-3079-17 17.0cm



CASTROVIEJO
FM- 11-3080-14 14.0cm
FM- 11-3080-17 17.0cm



JACOBSON
FM- 11-3081-18 18.5cm
FM- 11-3081-21 21.0cm



JACOBSON
FM- 11-3082-18 18.5cm
FM- 11-3082-21 21.0cm



CASTROVIEJO
FM- 11-3083-01 10.0cm
FM- 11-3083-02 10.0cm



CASTROVIEJO
FM- 11-3084-01 10.0cm
FM- 11-3084-02 10.0cm



FM- 11-3085-16
16.0cm



FM- 11-3086-01 23.0cm Fig.1
 FM- 11-3086-02 23.0cm Fig.2
 FM- 11-3086-03 19.0cm Fig.3



CASTROVIEJO-BARRAQUER
 FM- 11-3087-12
 12.0cm



CASTROVIEJO
 FM- 11-3088-13
 13.0cm



CASTROVIEJO
 FM- 11-3089-12
 12.0cm

EN	Reverdin Needles
DE	Reverdin-Nedeln
ES	Agujas de reverdin
FR	Aiguilles de Reverdin
IT	Reverdin Needles

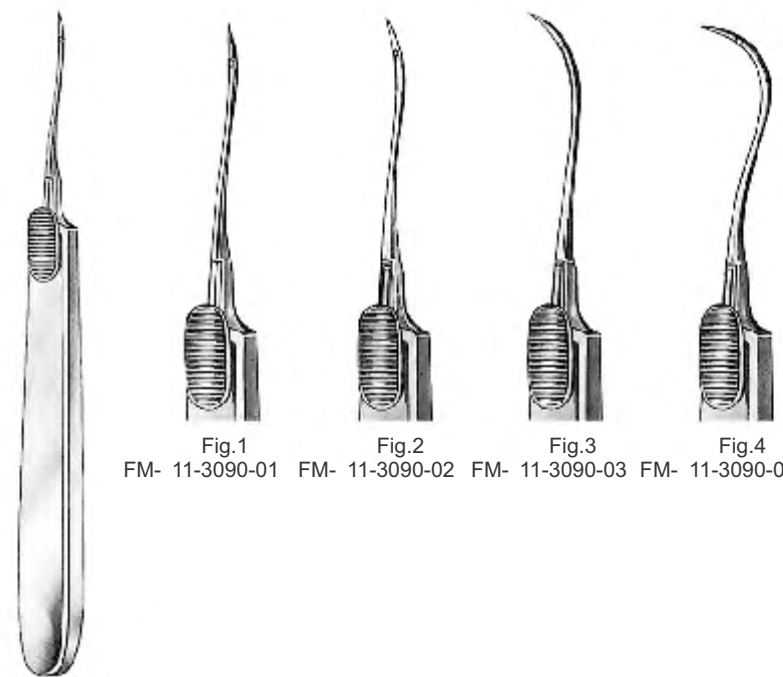

Fig.1
FM- 11-3090-01

Fig.2
FM- 11-3090-02

Fig.3
FM- 11-3090-03

Fig.4
FM- 11-3090-04

REVERDIN
14.0cm

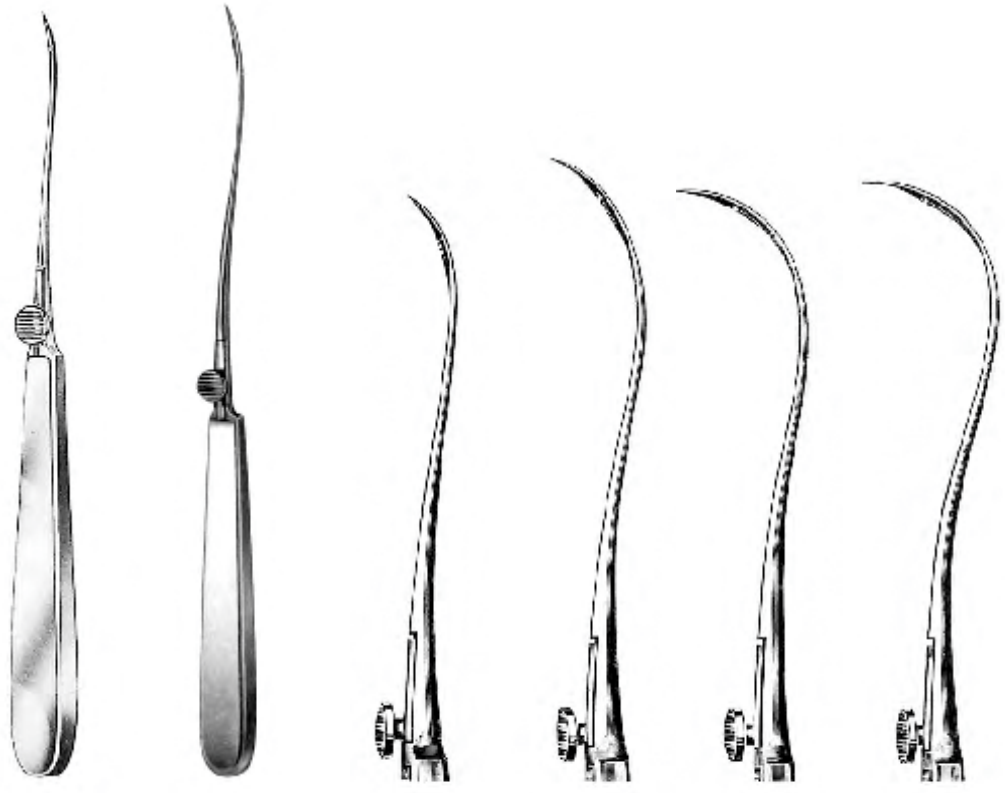

REVERDIN
19.0cm
21.0cm

REVERDIN
23.0cm

Fig.1
FM- 11-3091-01 FM- 11-3092-01 FM- 11-3093-01

Fig.2
FM- 11-3091-02 FM- 11-3092-02 FM- 11-3093-02

Fig.3
FM- 11-3091-03 FM- 11-3092-03 FM- 11-3093-03

Fig.4
FM- 11-3091-04 FM- 11-3092-04 FM- 11-3093-04

Ligature Needles EN

Unterbindungsnadeln DE

Agujas para ligaduras ES

Aiguilles de ligatures FR

Aghi per legature IT

11



FAIZAN & MUSA
SPECIAL INSTRUMENTS

SUTURE



sharp

FM- 11-3094-20 20.0cm
FM- 11-3095-20 20.0cm



blunt

FM- 11-3096-20 20.0cm
FM- 11-3097-20 20.0cm

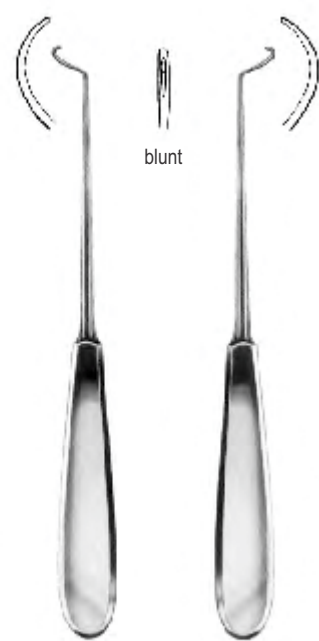

blunt

FM- 11-3098-20 20.0cm
FM- 11-3099-20 20.0cm



sharp

DESCHAMPS
FM- 11-3100-21 21.0cm
FM- 11-3101-21 21.0cm

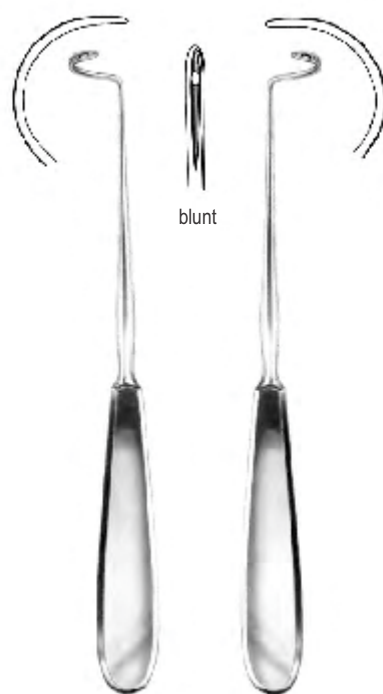

blunt

DESCHAMPS
FM- 11-3102-21 21.0cm
FM- 11-3103-21 21.0cm

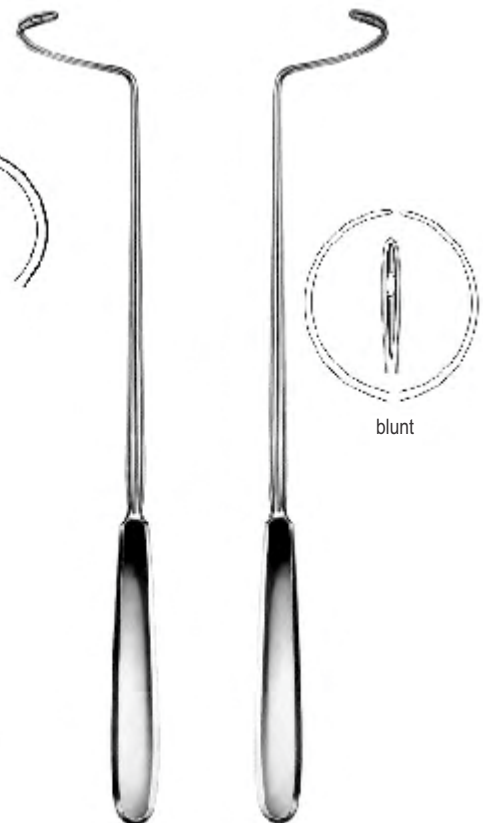

blunt

DESCHAMPS
FM- 11-3104-28 28.0cm
FM- 11-3105-28 28.0cm



MICHEL
 FM- 11-3118-12
 12.0cm



MICHEL
 FM- 11-3119-12
 12.0cm



WACHENFELDT
 FM- 11-3120-12
 12.5cm



WACHENFELDT
 FM- 11-3121-12
 12.0cm



WACHENFELDT
 FM- 11-3122-12
 12.5cm



HEGENBARTH
 FM- 11-3123-12
 12.5cm



CHILDE
 FM- 11-3124-18
 18.0cm



CHILDE
 FM- 11-3125-18
 18.0cm



MICHEL
 FM- 11-3126-12
 12.5cm

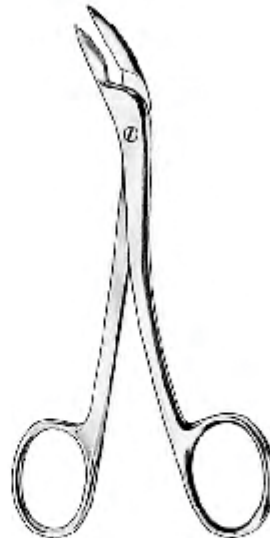

RICHTER- HEATH
 FM- 11-3127-14
 14.0cm







COLLIN
 FM- 11-3128-13
 13.0cm

TC GOLD



Castroviejo

		Smooth	
			
14cm/5½"	FM- 11-3131-14	FM- 11-3132-14	
18cm/7"	FM- 11-3131-18	FM- 11-3132-18	
21cm/8¼"	FM- 11-3131-21	FM- 11-3132-21	
			
14cm/5½"	FM- 11-3133-14	FM- 11-3134-14	
18cm/7"	FM- 11-3133-18	FM- 11-3134-18	
21cm/8¼"	FM- 11-3133-21	FM- 11-3134-21	



Kalt
14cm/5½"

	FM- 11-3135-14
	FM- 11-3136-14



Barraquer
FM- 11-3137-14
14cm/5 ½"



Castroviejo
FM- 11-3138-13
13cm/5"



Hepp-Schiedel
18cm/7"

	FM- 11-3139-18
	FM- 11-3140-18
	Smooth

EN	Needle Holders
DE	Nadelhalter
ES	Porta-agujas
FR	Porte-aiguilles
IT	Porta-aghi

TC GOLD

SUTURE

Two rings angled



Neivert
FM- 11-3146-13
13 cm/5"



Neivert
FM- 11-3147-13
13 cm/5"



Webster
FM- 11-3148-13
13 cm/5"

Smooth



Derf
FM- 11-3149-12
12.5 cm/5"



New Orleans
FM- 11-3150-18
18 cm/7"



Bozemann
FM- 11-3151-20 20 cm/8"
FM- 11-3151-24 24 cm/9 1/2"
FM- 11-3151-26 26 cm/10 1/2"

TC GOLD

SUTURE



Mayo-Hegar

- | | | |
|----------------|----------------|-----------|
| FM- 11-3152-16 | | 16cm/6¼" |
| FM- 11-3152-18 | | 18cm/7" |
| FM- 11-3152-20 | FM- 11-3153-20 | 20cm/8" |
| FM- 11-3152-24 | FM- 11-3153-24 | 24cm/9½" |
| FM- 11-3152-26 | FM- 11-3153-26 | 26cm/10½" |
| FM- 11-3152-30 | | 30cm/12" |



Hegar-Baumgartner
FM- 11-3154-14
14cm/5½"



Heavy Pattern

- Mayo-Hegar**
FM- 11-3155-20 20cm/8"
FM- 11-3155-24 24cm/9½"



- De Bakey**
FM- 11-3156-18 18cm/7"
FM- 11-3156-20 20cm/8"
FM- 11-3156-23 23cm/9"
FM- 11-3156-26 26cm/10¼"
FM- 11-3156-31 31cm/12¼"



- De Bakey-Fine**
FM- 11-3157-18 18cm/7"
FM- 11-3157-20 20cm/8"
FM- 11-3157-23 23cm/9"
FM- 11-3157-26 26cm/10¼"
FM- 11-3157-31 31cm/12¼"

EN	Needle Holders
DE	Nadelhalter
ES	Porta-agujas
FR	Porte-aiguilles
IT	Porta-aghi

TC GOLD



Baby-Crile-Wood
FM- 11-3158-15
15cm/6"



Crile-Wood
15cm/6"



Crile-Wood

	cm	in
FM- 11-3161-18	18	7"
FM- 11-3161-20	20	8"
FM- 11-3161-23	23	9"
FM- 11-3161-26	26	10 1/4"
FM- 11-3161-31	31	12 1/4"

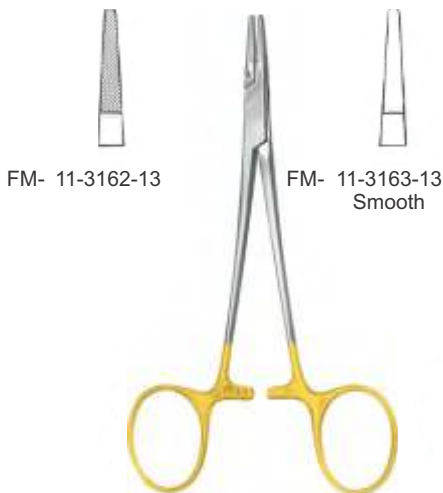

Halsey
13cm/5"

FM- 11-3162-13

FM- 11-3163-13
Smooth



Converse
FM- 11-3164-12
12.5cm/5"



Kilner
FM- 11-3165-13
13.5cm/5 1/4"

TC GOLD



Hegar-Vascular

- FM- 11-3166-14 14cm/5½"
- FM- 11-3166-18 18cm/7"
- FM- 11-3166-20 20cm/8"
- FM- 11-3166-23 23cm/9"



Ryder

- FM- 11-3167-13
- FM- 11-3167-15
- FM- 11-3167-18
- FM- 11-3167-20
- FM- 11-3167-23
- FM- 11-3167-26



Micro-Ryder

- FM- 11-3168-13 13cm/5"
- FM- 11-3168-15 15cm/6"
- FM- 11-3168-18 18cm/7"
- FM- 11-3168-20 20cm/8"
- FM- 11-3168-23 23cm/9"
- FM- 11-3168-26 26cm/10¼"



(Swedish Pattern)

- FM- 11-3169-15 15cm/6"
- FM- 11-3169-17 17cm/6¾"
- FM- 11-3169-20 20cm/8"



Sartor

- FM- 11-3170-18 18cm/7"
- FM- 11-3170-26 26cm/10¼"

EN	Needle Holders
DE	Nadelhalter
ES	Porta-agujas
FR	Porte-aiguilles micro
IT	Porta microaghi



FAIZAN & MUSA
SPECIAL INSTRUMENTS

TC GOLD



Mathieu

- 14cm/5½" FM- 11-3175-14
- 17cm/6¾" FM- 11-3175-17
- 20cm/8" FM- 11-3175-20
- 24cm/9½" FM- 11-3175-24



Mathieu

- FM- 11-3176-14
- FM- 11-3176-17
- FM- 11-3176-20
- FM- 11-3176-24



Mathieu-Ryder

- FM- 11-3177-17
- FM- 11-3177-20



Langenbeck

- 16cm/6¼" FM- 11-3178-16
- 18cm/7" FM- 11-3178-18
- 20cm/8" FM- 11-3178-20



Langenbeck-Ryder

- FM- 11-3179-18
- FM- 11-3179-20



Lichtenberg

- FM- 11-3180-20

Needle Holders EN

Nadelhalter DE

Porta-agujas ES

Porte-aiguilles micro FR

Porta microaghi IT

11



FAIZAN & MUSA
SPECIAL INSTRUMENTS

SUTURE

TC GOLD



FM- 11-3185-20 20 cm/8"
FM- 11-3185-25 25 cm/10"



Mathieu
FM- 11-3186-20 20 cm/8"
FM- 11-3186-24 24 cm/9½"



Metzenbaum
FM- 11-3187-17 17 cm/6 ¾"
FM- 11-3187-20 20 cm/8"



FM- 11-3188-16 FM- 11-3189-16

Arruga
16 cm/6¼"



Boynton
FM- 11-3190-12 12 cm/4¾"



Hosel
FM- 11-3191-20 20 cm/8"
FM- 11-3191-25 25 cm/10"

EN Needle Holders

DE Nadelhalter

ES Porta-agujas

FR Porte-aiguilles

IT Porta-aghi

FAIZAN & MUSA
SPECIAL INSTRUMENTS

TC GOLD



Baby-Olsen-Hegar
FM- 11-3192-11
11.5 cm/4½"



Olsen-Hegar
FM- 11-3193-14
14 cm/5½"



Olsen-Hegar
FM- 11-3194-17
17 cm/6¾"



Olsen-Hegar
FM- 11-3195-18
18 cm/7"



Gillies-Slim
FM- 11-3196-14
14.5 cm/5½"



Gillies
FM- 11-3197-16 (right hand)
FM- 11-3198-16 (left hand)
16 cm/6¼"

- EN** **Neurosurgery**
- DE** **Neurochirurgie**
- ES** **Neuro Cirugía**
- FR** **Neurochirurgie**
- IT** **Neurochirurgia**

Page 137 to 148



- EN Dura Hooks, Nerve Hooks, Dura Dissectors
- DE Durahaken, Nervhaken, Dura-Dissektoren
- ES Ganchos para dura-madre, Ganchos para nervios, Disecadores de dura-madre
- FR Dura Hooks, Nerve Hooks, Dura Dissecteurs
- IT Dura Hooks, Nerve Hooks, Dura Dissectors



FAIZAN & MUSA
SPECIAL PATENTED

NEUROSURGERY



FRAZIER
FM- 12-3401-15
15 cm/5 7/8"



HOEN
FM- 12-3402-15
15 cm/5 7/8"



HOEN
FM- 12-3403-15
15 cm/5 7/8"



SACHS
FM- 12-3404-21
21 cm/8 1/4"



MILLIGAN
FM- 12-3405-21
21 cm/8 1/4"



SACHS
FM- 12-3406-21
21 cm/8 1/4"



FM- 12-3407-22
22 cm/8 3/4"



WOODSON
FM- 12-3408-25
25 cm/9 7/8"



DAVIS
FM- 12-3409-24
24.5 cm/9 5/8"



FM- 12-3410-21
21 cm/8 1/4"



FAGER
FM- 12-3411-20
20 cm/7 7/8"



FAGER
FM- 12-3412-20
20 cm/7 7/8"

Nerve Root Retractors, Dura Dissectors **EN**

Nervwurzelhaken, Dura-Dissektoren **DE**

Separadores para la raiz de nervio, Disecadores de dura-madre **ES**

Rétracteurs de racine nerveuse, dissecteurs de Dura **FR**

Retrattori di radici nervose, Dissestori di Dura **IT**

12



FAIZAN & MUSA
SPECIAL INSTRUMENTS

NEUROSURGERY



LOVE

FM- 12-3413-21
21.5 cm/8 1/2"

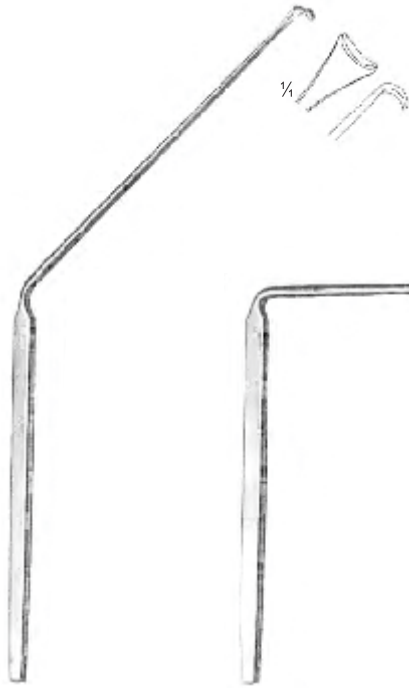

LOVE

FM- 12-3414-17
17.5 cm/6 7/8"

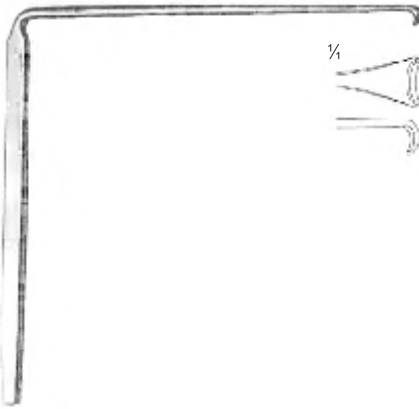

LOVE

FM- 12-3415-11
11 cm/4 3/8"



WOODSON

FM- 12-3416-17
17 cm/6 3/4"



HORSLEY

FM- 12-3417-20
20 cm/7 7/8"



SACHS

FM- 12-3418-21
21 cm/8 1/4"



FM- 12-3419-16

16 cm/6 1/4"



TOENNIS

FM- 12-3420-20
25 cm/9 7/8"

- EN Cranial Opening, Clip Applying Forceps
- DE Schädelzangen, Clips und Anlegezangen
- ES Pinzas sacabocados craneales, Grapas y pinzas aplicadoras
- FR Ouverture crânienne, pince à application de pince
- IT Apertura cranica, pinzette per applicazione a clip

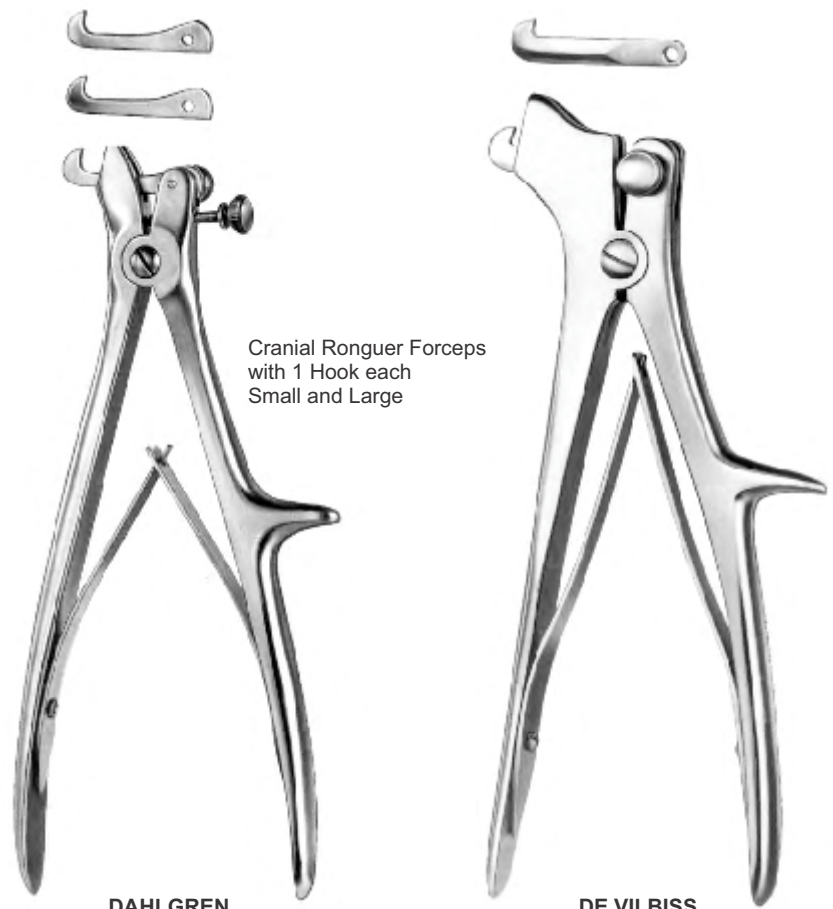

Cranial Ronguer Forceps
with 1 Hook each
Small and Large

DAHLGREN
FM- 12-3421-20
20 cm/7 7/8"

DE VILBISS
FM- 12-3422-21
21 cm/8 1/4"



McKENZIE
FM- 12-3423-15 15cm/5 7/8"
FM- 12-3423-19 19cm/7 1/2"

McKENZIE
FM- 12-3424-15 15cm/5 7/8"
FM- 12-3424-19 19cm/7 1/2"

RANEY
FM- 12-3425
Applying and removing
forceps for scalp hemostasis clip



- FM- 12-3426-30 30cm
- FM- 12-3426-40 40cm
- FM- 12-3426-50 50cm
- FM- 12-3426-60 60cm
- FM- 12-3426-70 70cm

GIGLI-WIRE SAW
 2 wires twisted

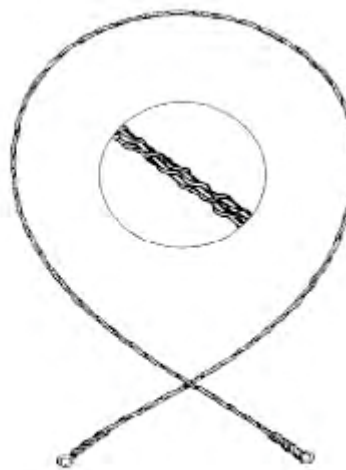

- FM- 12-3427-30 30cm
- FM- 12-3427-40 40cm
- FM- 12-3427-50 50cm

GIGLI-WIRE SAW
 6 wires twisted



GIGLI
 FM- 12-3428-07
 7 cm/2 3/4"
 Hook handle
 for wire saw



De MARTEL
 FM- 12-3429-33
 33 cm/13"
 Conductor for
 wire saws

EN	Nerve Hooks
DE	Nervhaken
ES	Ganchos para nervios
FR	Crochets nerveux
IT	Ganci nervosi

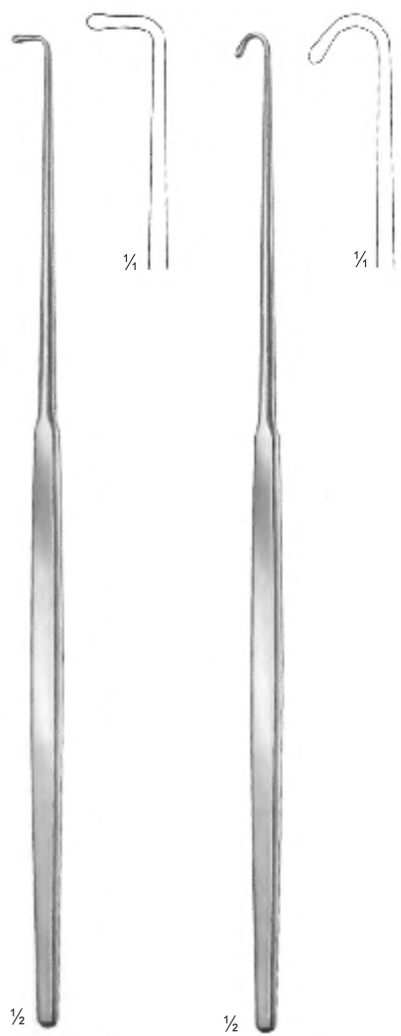

GRONINGEN
FM- 12-3443-26
26.5 cm/10 3/8"

GRONINGEN
FM- 12-3444-26
26.5 cm/10 3/8"

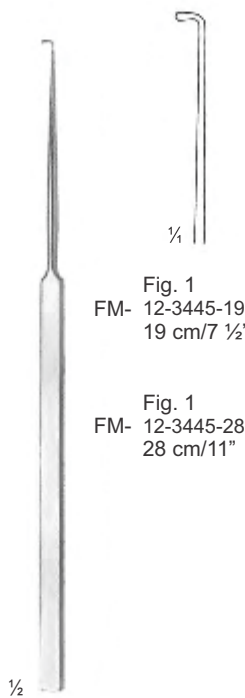

CUSHING

Fig. 1
FM- 12-3445-19
19 cm/7 1/2"

Fig. 1
FM- 12-3445-28
28 cm/11"

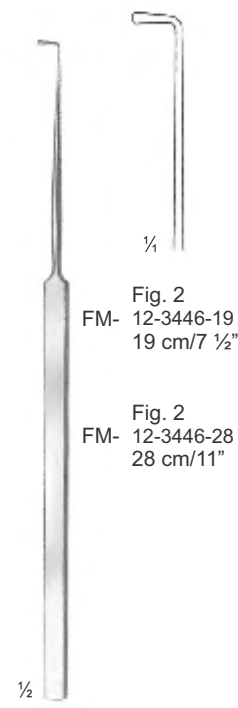

CUSHING

Fig. 2
FM- 12-3446-19
19 cm/7 1/2"

Fig. 2
FM- 12-3446-28
28 cm/11"



SMITHWICK

RAS-237-2787
17 cm/6 3/4"

FM- 12-3447-21
21 cm/8 1/4"

Lamina Spreaders **EN**

Wirbelkörperspeizer **DE**

Separadores para cuerpos vertebrales **ES**

Lamina Spreaders **FR**

Spargisale della Lamina **IT**

12



FAIZAN & MUSA
SPECIAL INSTRUMENTS

NEUROSURGERY

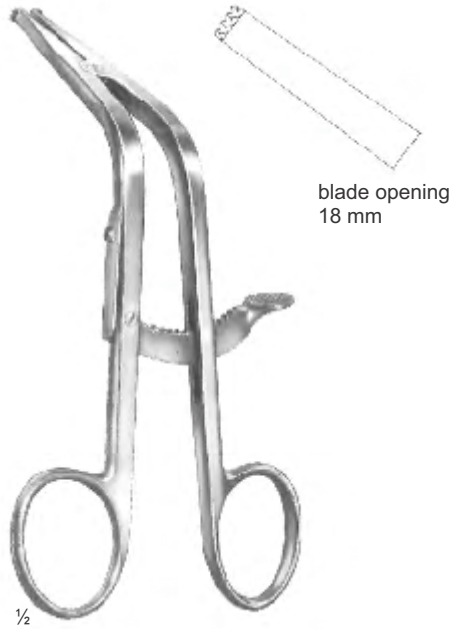

blade opening
18 mm

1/2

CLOWARD
FM- 12-3456-16
16 cm/6 1/4"

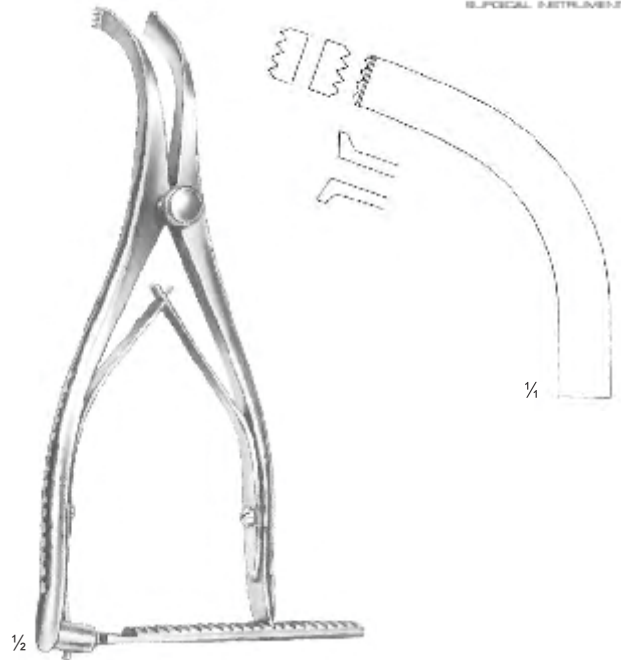

1/2

INGE
FM- 12-3457-16
16.5 cm/6 1/2"
Blade opening 35 mm

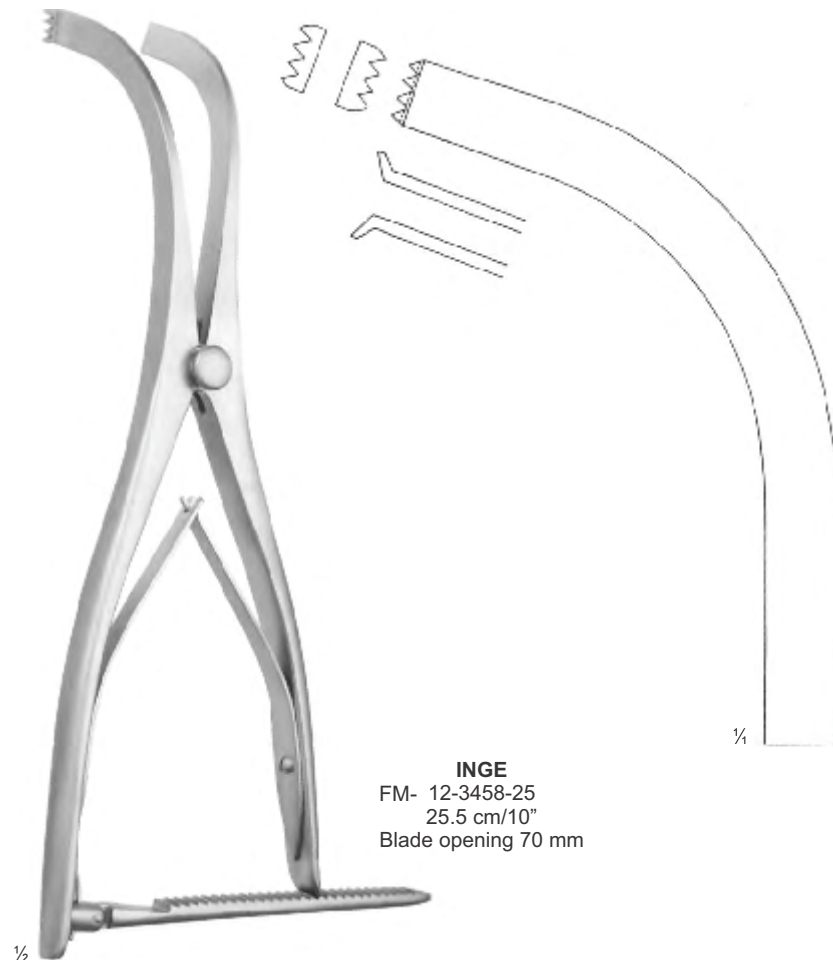

1/2

INGE
FM- 12-3458-25
25.5 cm/10"
Blade opening 70 mm

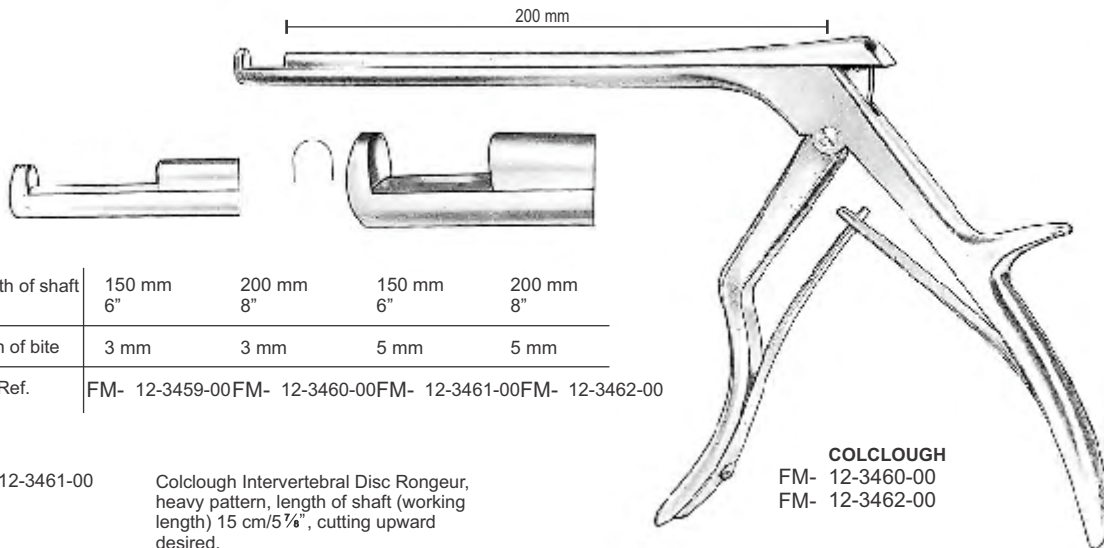
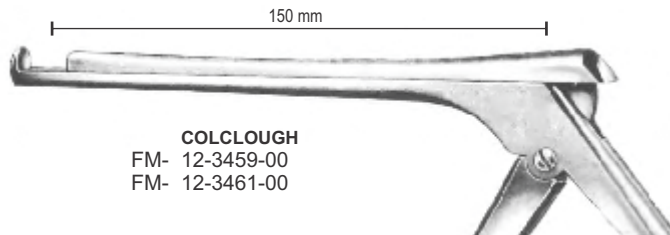

Length of shaft	150 mm 6"	200 mm 8"	150 mm 6"	200 mm 8"
Width of bite	3 mm	3 mm	5 mm	5 mm
Cat. Ref.	FM- 12-3459-00 FM- 12-3460-00 FM- 12-3461-00 FM- 12-3462-00			

- FM- 12-3459-00 - 12-3461-00 Colclough Intervertebral Disc Rongeur, heavy pattern, length of shaft (working length) 15 cm/5 7/8", cutting upward desired.
- FM- 12-3460-00 - 12-3462-00 ditto, length of shaft (working length) 20 cm/7 7/8"
- FM- 12-3462-00 - 12-3463-00 ditto, length of shaft (working length) 15 cm/5 7/8", cutting downward
- FM- 12-3462-00 - 12-3462-00 ditto, length of shaft (working length) 20 cm/7 7/8"

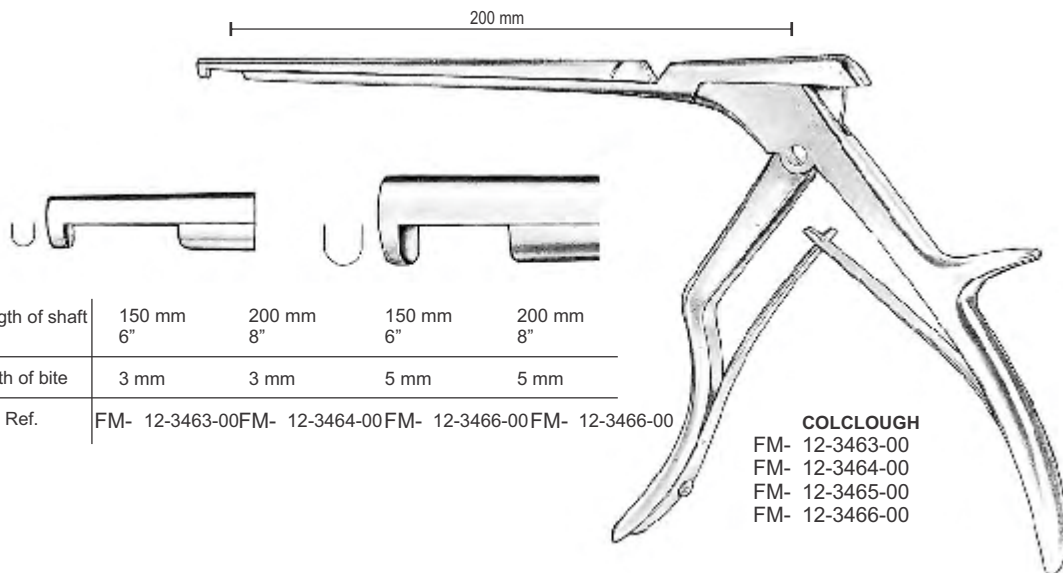
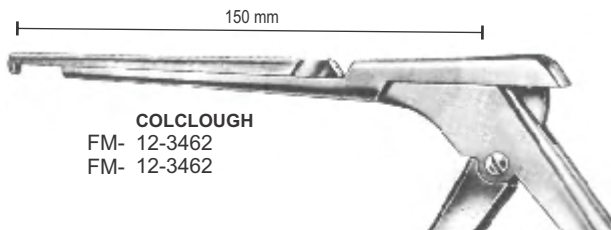

Length of shaft	150 mm 6"	200 mm 8"	150 mm 6"	200 mm 8"
Width of bite	3 mm	3 mm	5 mm	5 mm
Cat. Ref.	FM- 12-3463-00 FM- 12-3464-00 FM- 12-3466-00 FM- 12-3466-00			

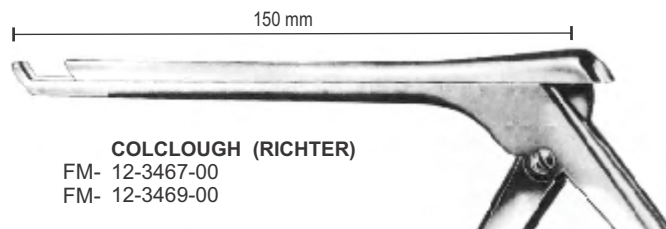
**COLCLOUGH (RICHTER)**

FM- 12-3467-00

FM- 12-3469-00

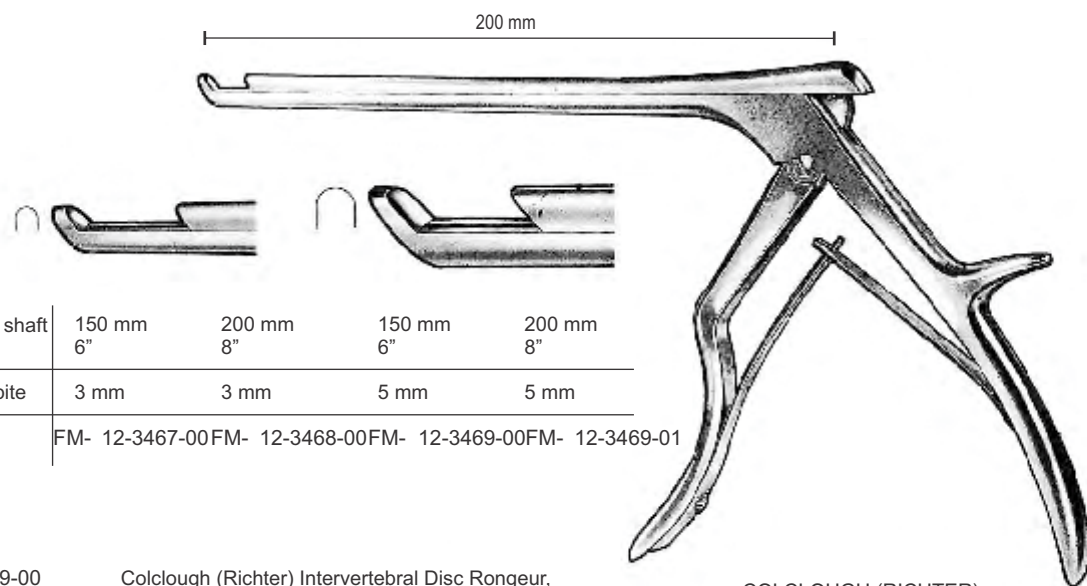

Length of shaft	150 mm 6"	200 mm 8"	150 mm 6"	200 mm 8"
Width of bite	3 mm	3 mm	5 mm	5 mm
Cat. Ref.	FM- 12-3467-00	FM- 12-3468-00	FM- 12-3469-00	FM- 12-3469-01

FM- 12-3467-00 - 12-3469-00

Colclough (Richter) Intervertebral Disc Rongeur,
heavy pattern, length of shaft (working
length) 15 cm/6", cutting 40° forward

COLCLOUGH (RICHTER)

FM- 12-3468-00

FM- 12-3469-01

FM- 12-3468-00 - 12-3469-01

ditto, length of shaft (working
length) 20 cm/7 7/8"

EN	Laminectomy Punches
DE	Laminektomiestanzen
ES	Pinzas cortantes para laminectomía
FR	Poinçons de laminectomie
IT	Punzoni per laminectomia

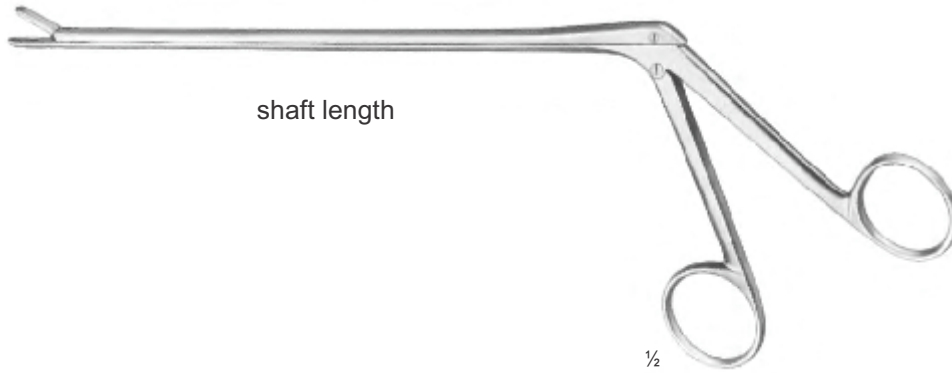

CUSHING
straight



- FM- 12-3470-12 120 mm
- FM- 12-3470-15 150 mm
- FM- 12-3470-18 180 mm

CUSHING
upwards

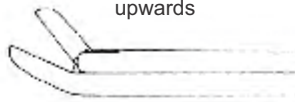

- FM- 12-3471-12 120 mm
- FM- 12-3471-15 150 mm
- FM- 12-3471-18 180 mm

CUSHING
downwards

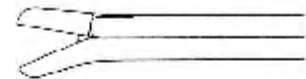

- FM- 12-3472-12 120 mm
- FM- 12-3472-15 150 mm
- FM- 12-3472-18 180 mm

LOVE-GRUENWALD
straight



- FM- 12-3473-12 120 mm
- FM- 12-3473-15 150 mm
- FM- 12-3473-18 180 mm

LOVE-GRUENWALD
upwards

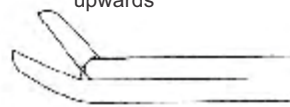

- FM- 12-3474-12 120 mm
- FM- 12-3474-15 150 mm
- FM- 12-3474-18 180 mm

LOVE-GRUENWALD
downwards

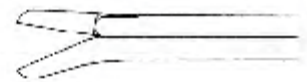

- FM- 12-3475-12 120 mm
- FM- 12-3475-15 150 mm
- FM- 12-3475-18 180 mm

SPURLING
straight



- FM- 12-3476-12 120 mm
- FM- 12-3476-15 150 mm
- FM- 12-3476-18 180 mm

SPURLING
upwards





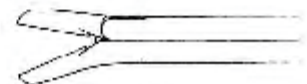

- FM- 12-3477-12 120 mm
- FM- 12-3477-15 150 mm
- FM- 12-3477-18 180 mm

SPURLING
downwards

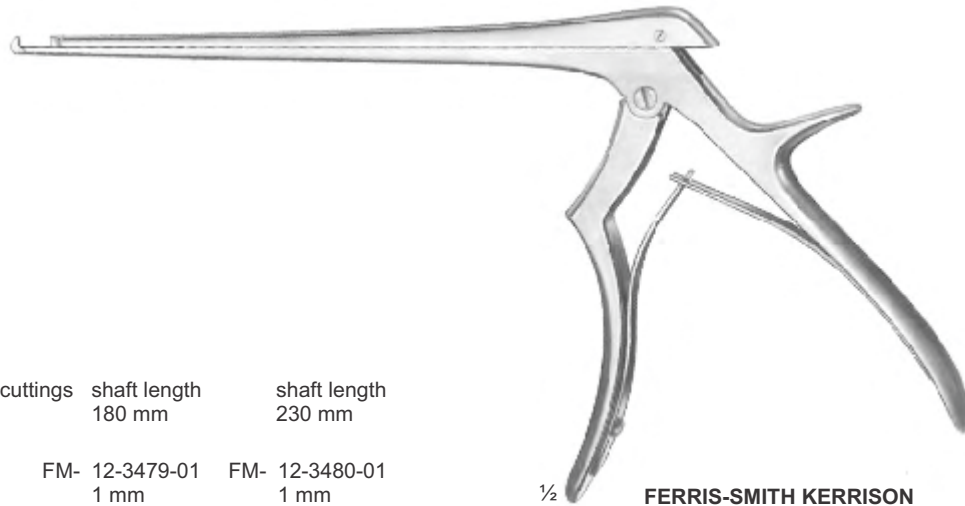

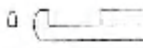

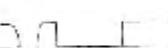





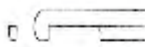
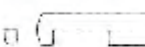
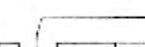

- FM- 12-3478-12 120 mm
- FM- 12-3478-15 150 mm
- FM- 12-3478-18 180 mm

 ½ **FERRIS-SMITH KERRISON**

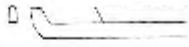
upwards cuttings	shaft length 180 mm	shaft length 230 mm
	FM- 12-3479-01 1 mm	FM- 12-3480-01 1 mm
	FM- 12-3479-02 2 mm	FM- 12-3480-02 2 mm
	FM- 12-3479-03 3 mm	FM- 12-3480-03 3 mm
	FM- 12-3479-04 4 mm	FM- 12-3480-04 4 mm
	FM- 12-3479-05 5 mm	FM- 12-3480-05 5 mm
	FM- 12-3479-06 6 mm	FM- 12-3480-06 6 mm

downwards cuttings	shaft length 180 mm
	FM- 12-3483-03 3 mm









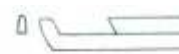
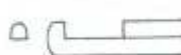

downwards cuttings	shaft length 180 mm	shaft length 230 mm
	FM- 12-3481-01 1 mm	FM- 12-3482-01 1 mm
	FM- 12-3481-02 2 mm	FM- 12-3482-02 2 mm
	FM- 12-3483-03 3 mm	FM- 12-3482-03 3 mm
	FM- 12-3483-04 4 mm	FM- 12-3482-04 4 mm
	FM- 12-3483-05 5 mm	FM- 12-3482-05 5 mm
	FM- 12-3483-06 6 mm	FM- 12-3482-06 6 mm

upwards cuttings	shaft length 180 mm	shaft length 230 mm
	FM- 12-3484-01 1 mm	FM- 12-3485-01 1 mm
	FM- 12-3484-02 2 mm	FM- 12-3485-02 2 mm
	FM- 12-3484-03 3 mm	FM- 12-3485-03 3 mm
	FM- 12-3484-04 4 mm	FM- 12-3485-04 4 mm
	FM- 12-3484-05 5 mm	FM- 12-3485-05 5 mm
	FM- 12-3484-06 6 mm	FM- 12-3485-06 6 mm

EN	Laminectomy Punches
DE	Laminektomiestanzen
ES	Pinzas cortantes para laminectomía
FR	Poinçons de laminectomie
IT	Punzoni per laminectomia



FERRIS-SMITH KERRISON

upwards cuttings	shaft length 180 mm	shaft length 230 mm	upwards cuttings	shaft length 180 mm	shaft length 230 mm
	FM- 12-3486-1 1 mm	FM- 12-3487-1 1 mm		FM- 12-3488-1 1 mm	FM- 12-3489-1 1 mm
	FM- 12-3486-2 2 mm	FM- 12-3487-2 2 mm		FM- 12-3488-2 2 mm	FM- 12-3489-2 2 mm
	FM- 12-3486-3 3 mm	FM- 12-3487-3 3 mm		FM- 12-3488-3 3 mm	FM- 12-3489-3 3 mm
	FM- 12-3486-4 4 mm	FM- 12-3487-4 4 mm		FM- 12-3488-4 4 mm	FM- 12-3489-4 4 mm
	FM- 12-3486-5 5 mm	FM- 12-3487-5 5 mm		FM- 12-3488-5 5 mm	FM- 12-3489-5 5 mm
	FM- 12-3486-6 6 mm	FM- 12-3487-6 6 mm		FM- 12-3488-6 6 mm	FM- 12-3489-6 6 mm

Laminectomy Punches EN

Laminektomiestanzen DE

Pinzas cortantes para laminectomía ES

Poinçons de laminectomie FR

Punzoni per laminectomia IT

12



FAIZAN & MUSA
SPECIAL INSTRUMENTS

NEUROSURGERY

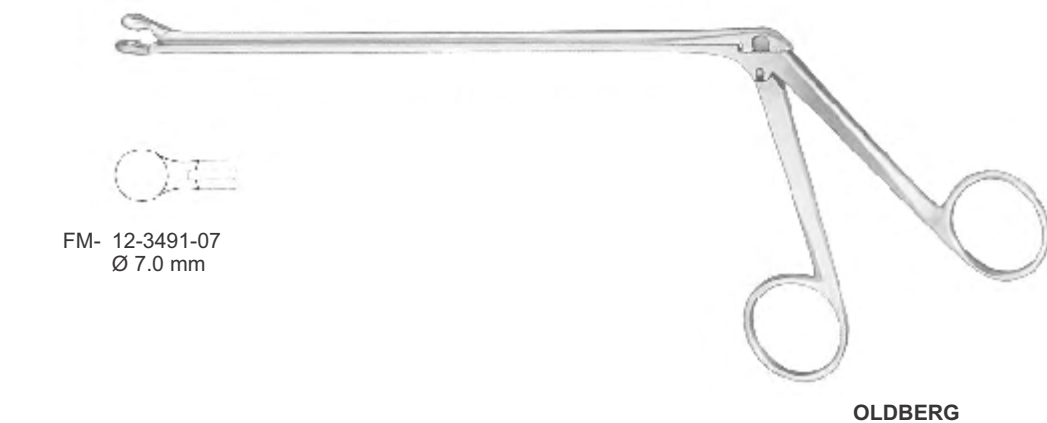
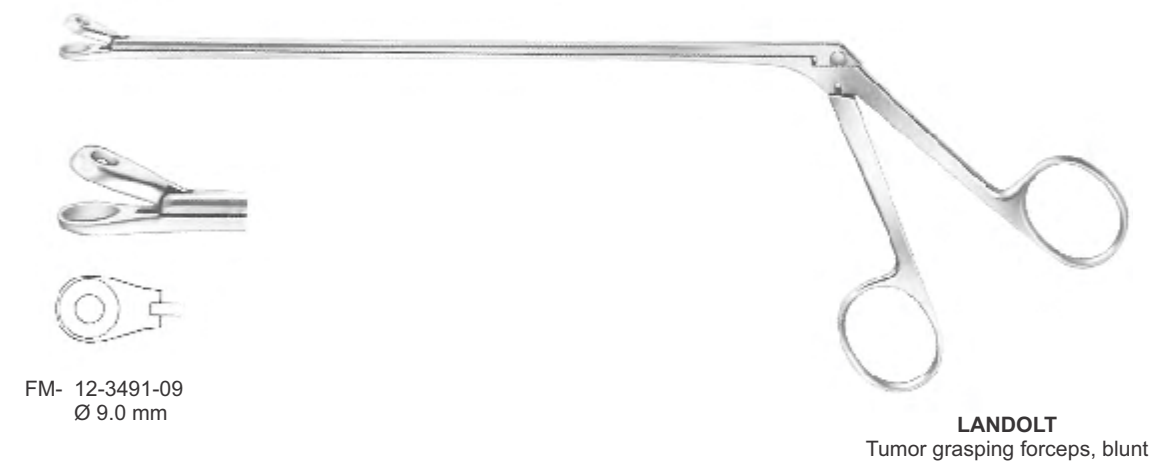
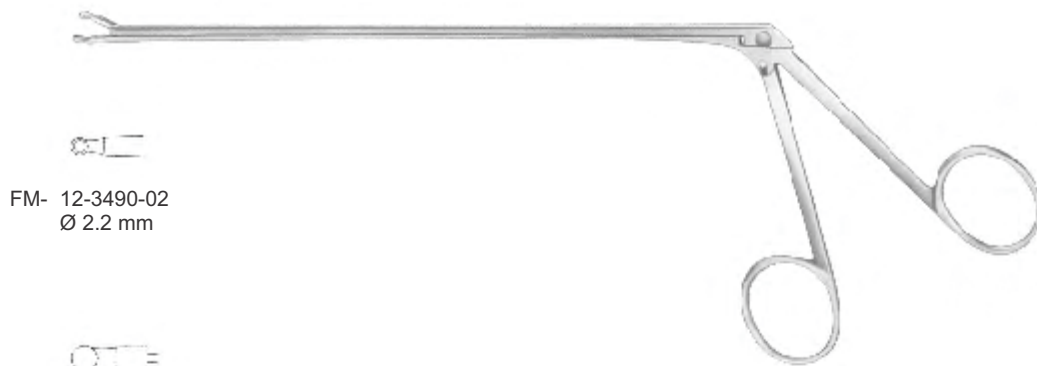

- EN** Cardiovascular Surgery
- DE** Herz- und Gefäßchirurgie
- ES** Cirugía cardiovascular
- FR** Chirurgie cardiovasculaire
- IT** Chirurgia cardiovascolare

Page 149 to 185



EN	Atrauma Tissue Forceps
DE	Atrauma Pinzetten
ES	Pinzas de disección Atrauma
FR	Atrauma Tissue Forceps
IT	Pinze per tessuti Atrauma



FM- 13-3601-12 12.5cm
FM- 13-3601-15 15cm

DEBAKEY-ADSON



1.0 mm



1.2 mm

FM- 13-3602-15 15.0cm FM- 13-3603-15 15.0cm
FM- 13-3602-18 18.0cm FM- 13-3603-18 18.0cm
FM- 13-3603-24 24.0cm

DEBAKEY-GERALD



1.0mm

FM- 13-3604-18
18.0cm

DEBAKEY-CUSHING



1.0mm



1.5mm

FM- 13-3605-15 15.0cm 13-3606-15
FM- 13-3605-19 19.0cm 13-3606-19
FM- 13-3605-24 24.0cm 13-3606-24

DEBAKEY-DIETRICH



1.0mm

FM- 13-3607-15 15.0cm
FM- 13-3607-19 19.0cm
FM- 13-3607-24 24.0cm

DEBAKEY-LIGHT



Also available in titanium

1.5 mm



- DE BAKLEY**
- FM- 13-3608-16 16.0cm
 - FM- 13-3608-20 20.0cm
 - FM- 13-3608-24 24.0cm
 - FM- 13-3608-30 30.0cm

2.0 mm



- DE BAKLEY**
- FM- 13-3609-16 16.0cm
 - FM- 13-3609-20 20.0cm
 - FM- 13-3609-24 24.0cm
 - FM- 13-3609-30 30.0cm

2.7 mm

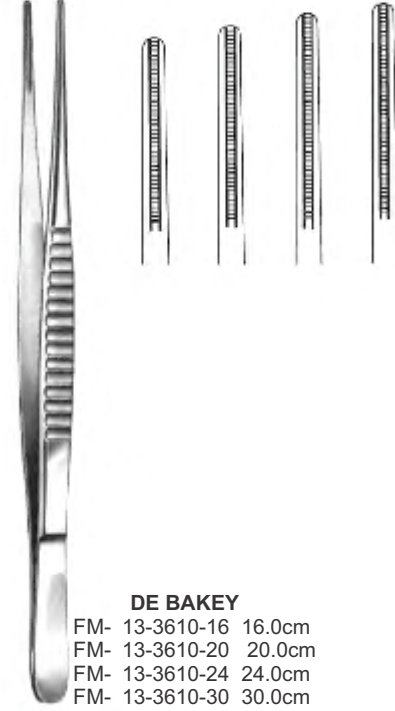

- DE BAKLEY**
- FM- 13-3610-16 16.0cm
 - FM- 13-3610-20 20.0cm
 - FM- 13-3610-24 24.0cm
 - FM- 13-3610-30 30.0cm

3.5mm

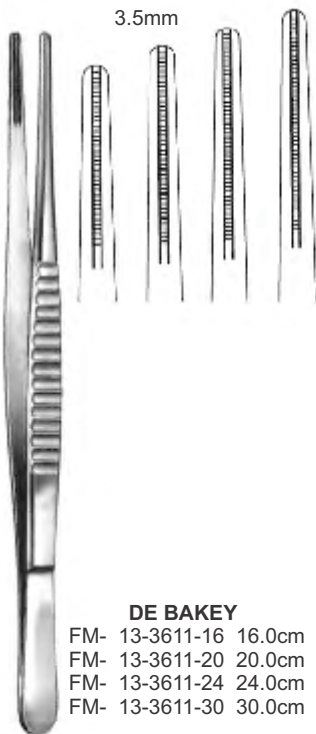

- DE BAKLEY**
- FM- 13-3611-16 16.0cm
 - FM- 13-3611-20 20.0cm
 - FM- 13-3611-24 24.0cm
 - FM- 13-3611-30 30.0cm

2mm

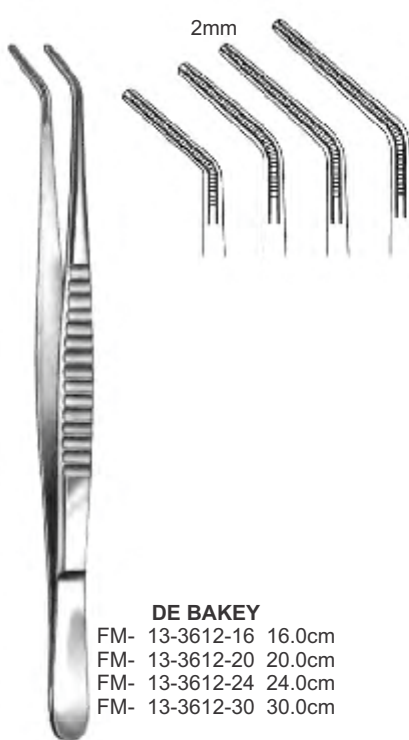

- DE BAKLEY**
- FM- 13-3612-16 16.0cm
 - FM- 13-3612-20 20.0cm
 - FM- 13-3612-24 24.0cm
 - FM- 13-3612-30 30.0cm

2.7mm



- DE BAKLEY**
- FM- 13-3613-16 16.0cm
 - FM- 13-3613-20 20.0cm
 - FM- 13-3613-24 24.0cm
 - FM- 13-3613-30 30.0cm

EN	Atrauma Bulldog Clamps
DE	Atrauma Bulldogklemmen
ES	Atrauma Clamps Bulldog
FR	Colliers Atrauma Bulldog
IT	Morsetti Bulldog Atrauma

Also available in titanium

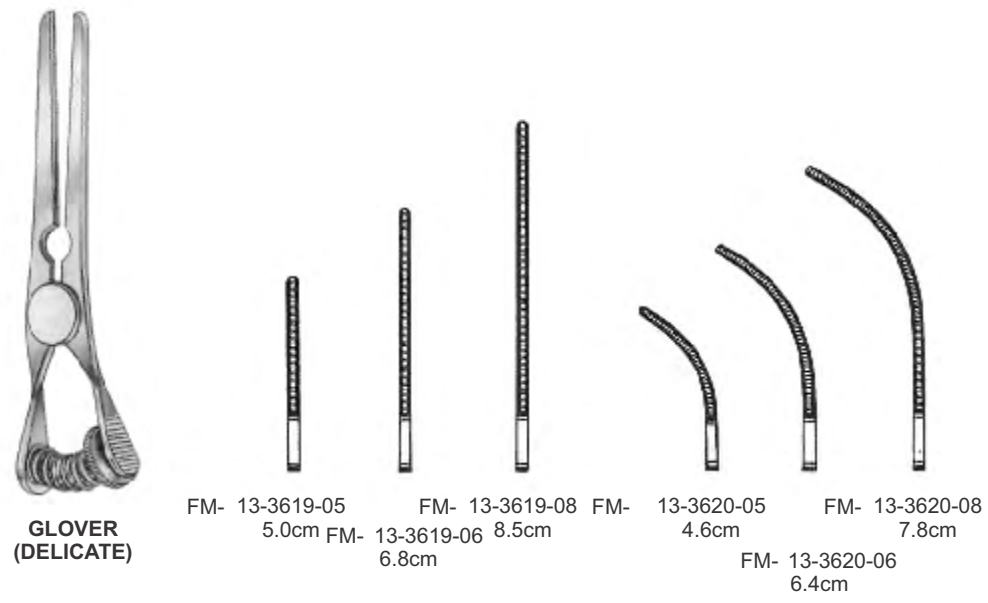
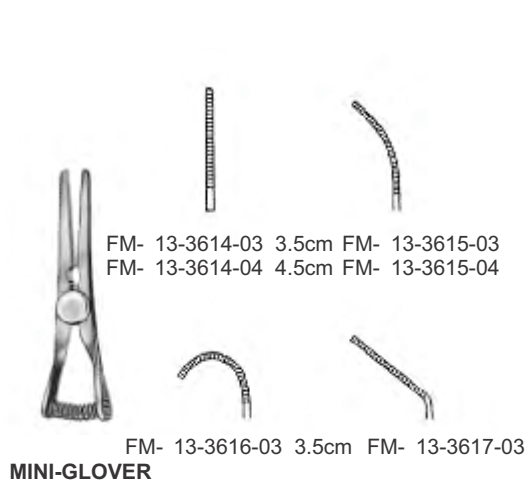

Also available in titanium

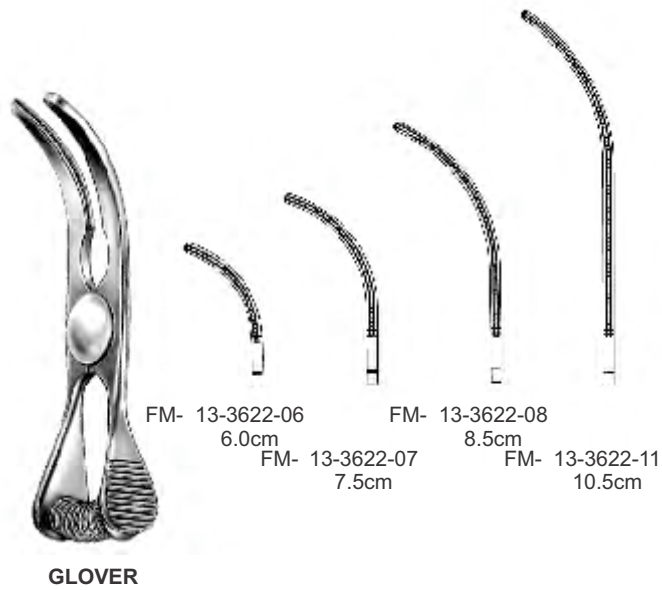
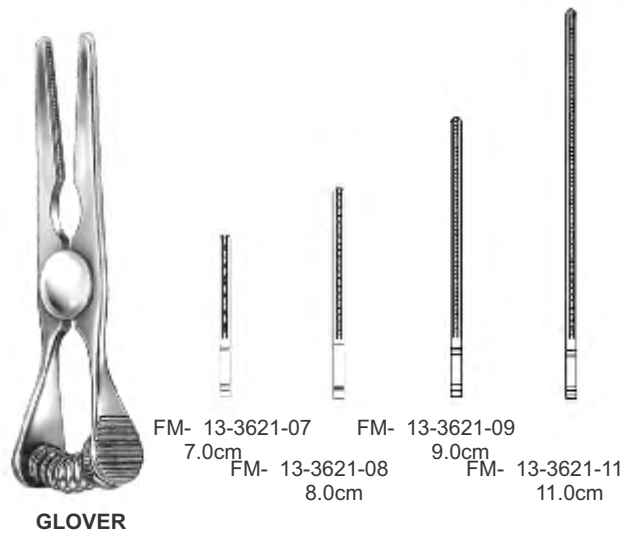

EN	Atrauma Bulldog Clamps
DE	Atrauma Bulldogklemmen
ES	Atrauma Clamps Bulldog
FR	Colliers Atrauma Bulldog
IT	Morsetti Bulldog Atrauma

Also available in titanium



GREGORY SOFT



FM- 13-3632-09
9.0cm

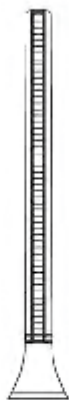

FM- 13-3632-11
11.0cm



GREGORY SOFT



FM- 13-3633-09
9.0cm

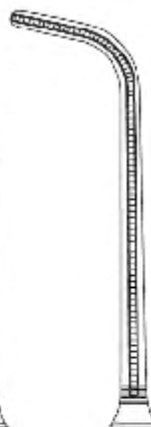

FM- 13-3633-11
11.0cm



GREGORY SOFT
11.0cm



FM- 13-3634-01



FM- 13-3634-02



SANTULLI
FM- 13-3635-07
7.0cm

Atrauma Cardiovascular Forceps	EN
Atrauma cardiovascular-klemmen	DE
Atrauma cardiovasculaire Forceps	ES
Pince cardiovasculaire Atrauma	FR
Pinza cardiovascolare Atrauma	IT

13

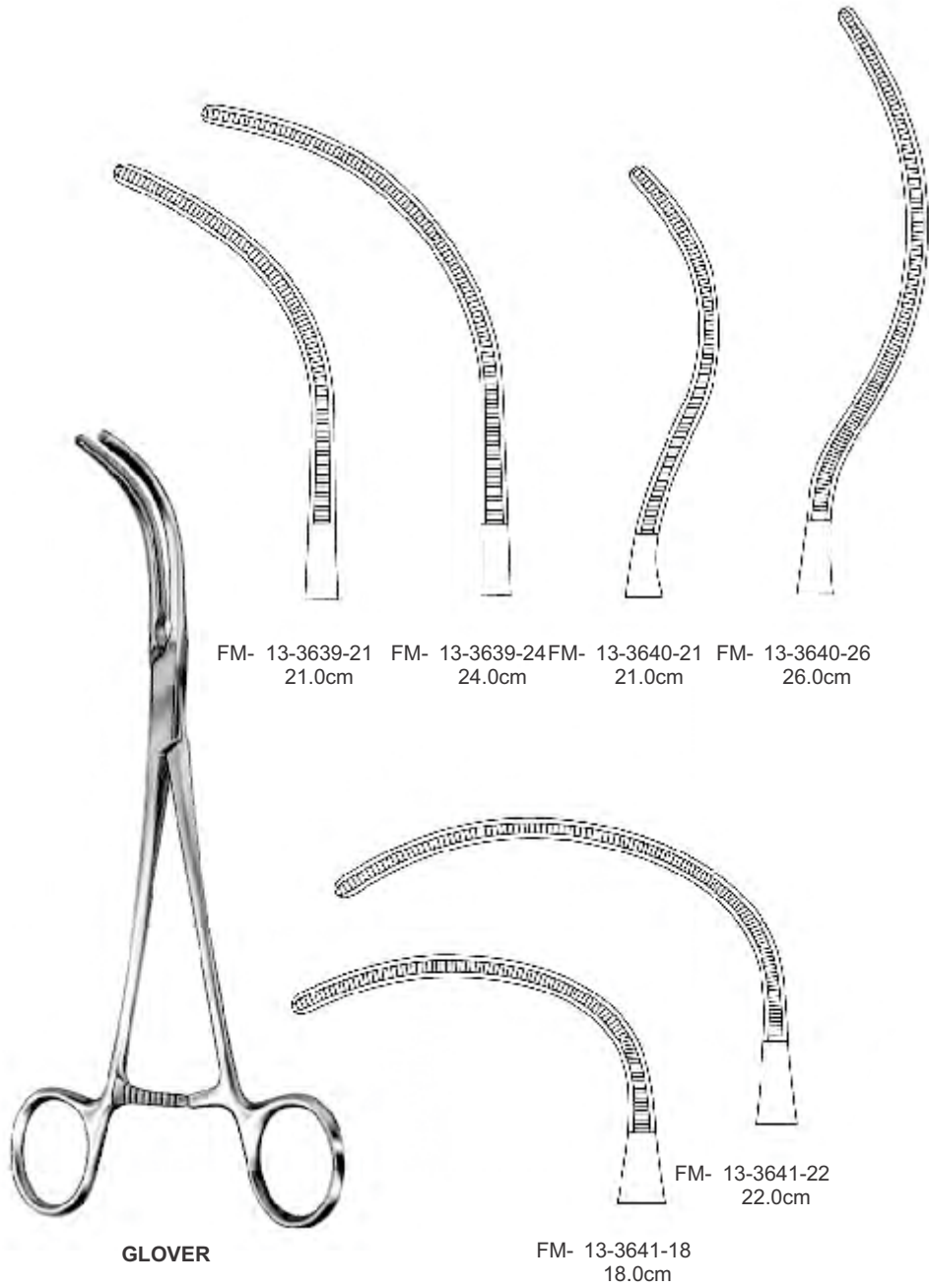

EN	Atrauma Cardiovascular Forceps
DE	Atrauma cardiovascular-klemmen
ES	Atrauma pinzas-clamps cardiovasculares
FR	Pince cardiovasculaire Atrauma
IT	Pinza cardiovascolare Atrauma

CARDIOVASCULAR

Dissecting and Ligature Forceps



De Bakey

FM- 13-3643-19
19 cm/8"



FM- 13-3643-23
23 cm/9 1/2"



De Bakey

FM- 13-3644-20
20 cm/8"



FM- 13-3644-18
18 cm/7 1/2"



De Bakey



Leland-Jones

FM- 13-3645-01
19.5 cm/7 1/2"



FM- 13-3645-02
19.5 cm/7 1/2"



FM- 13-3645-03
19.5 cm/7 1/2"

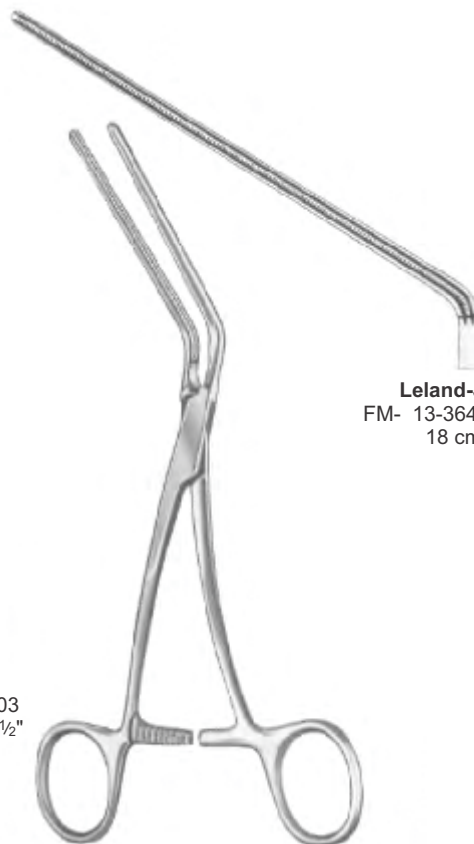

Leland-Jones
FM- 13-3646-18
18 cm/7"

Atrauma Cardiovascular Forceps **EN**
 Atrauma cardiovascular-klemmen **DE**
 Atrauma cardiovasculaire Forceps **ES**
 Pince cardiovasculaire Atrauma **FR**
 Pinza cardiovascolare Atrauma **IT**

13



FAIZAN & MUSA
SPECIAL INSTRUMENTS

CARDIOVASCULAR

Aortic Aneurysm Clamps



De Bakey



De Bakey



- FM- 13-3647-24
26 cm/10 1/2"
- FM- 13-3647-27
27 cm/10 1/2"
- FM- 13-3647-31
31 cm/12 1/4"
- FM- 13-3647-33
33 cm/13 1/4"



De Bakey-Bainbirdge



FM- 13-3648-15
15 cm/6"



FM- 13-3648-18
18 cm/7"



FM- 13-3649-15
15 cm/6"



FM- 13-3649-18
18 cm/7"



De Bakey
FM- 13-3649-20
20 cm/8"

- EN Atrauma Cardiovascular Forceps
- DE Atrauma cardiovascular-klemmen
- ES Atrauma pinzas-clamps cardiovasculares
- FR Pince cardiovasculaire Atrauma
- IT Pinza cardiovascolare Atrauma

CARDIOVASCULAR



De Bakey



FM- 13-3654-01
24 cm/9½"



FM- 13-3654-02
24 cm/9½"

Auricle Clamp



Harken



FM- 13-3654-03
24 cm/9½"



FM- 13-3654-04
24 cm/9½"



De Bakey

Bronchus Clamps

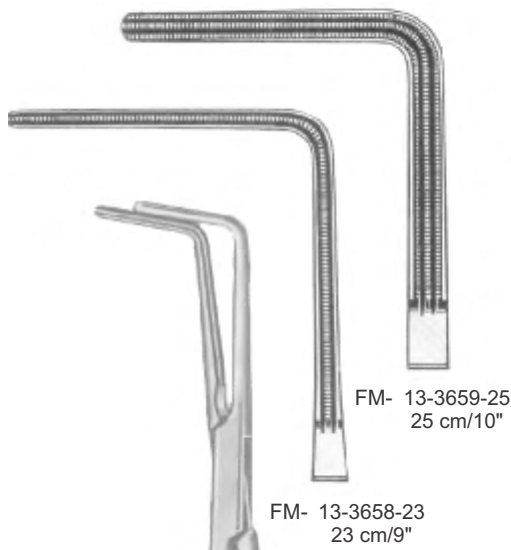

Lees



Lees
FM- 13-3660-25
25 cm/10"



De Bakey

Aortic Clamp

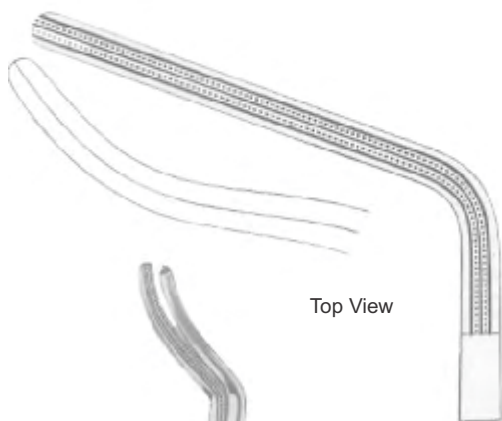

Top View



De Bakey
 FM- 13-3661-27
 27 cm/10½"



De Bakey
 FM- 13-3662-24
 24 cm/9½"

Ligature Clamps



De Bakey
 FM- 13-3663-24
 24 cm/9½"

Atrauma Cardiovascular Forceps	EN
Atrauma cardiovascular-klemmen	DE
Atrauma pinzas-clamps cardiovasculares	ES
Pince cardiovasculaire Atrauma	FR
Pinza cardiovascolare Atrauma	IT

13



CARDIOVASCULAR



De Bakey

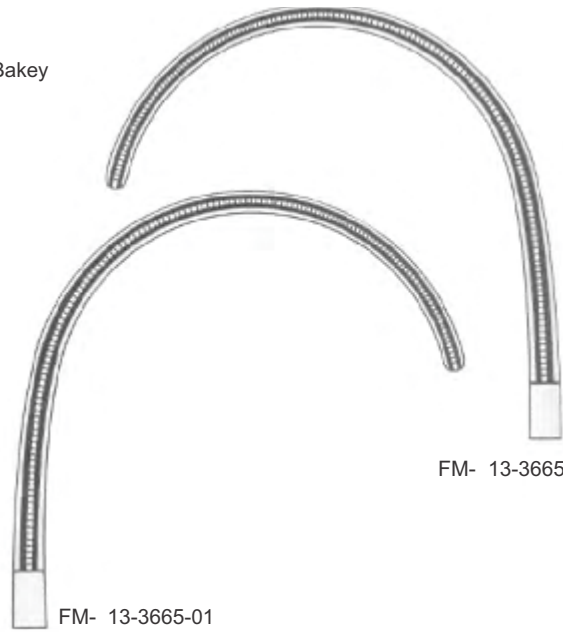

FM- 13-3665-02

FM- 13-3665-01

Ligature clamp,
Aortic clamp



De Bakey
FM- 13-3664-26
26.5 cm/10½"

De Bakey-Semb
FM- 13-3664-25
25 cm/10"

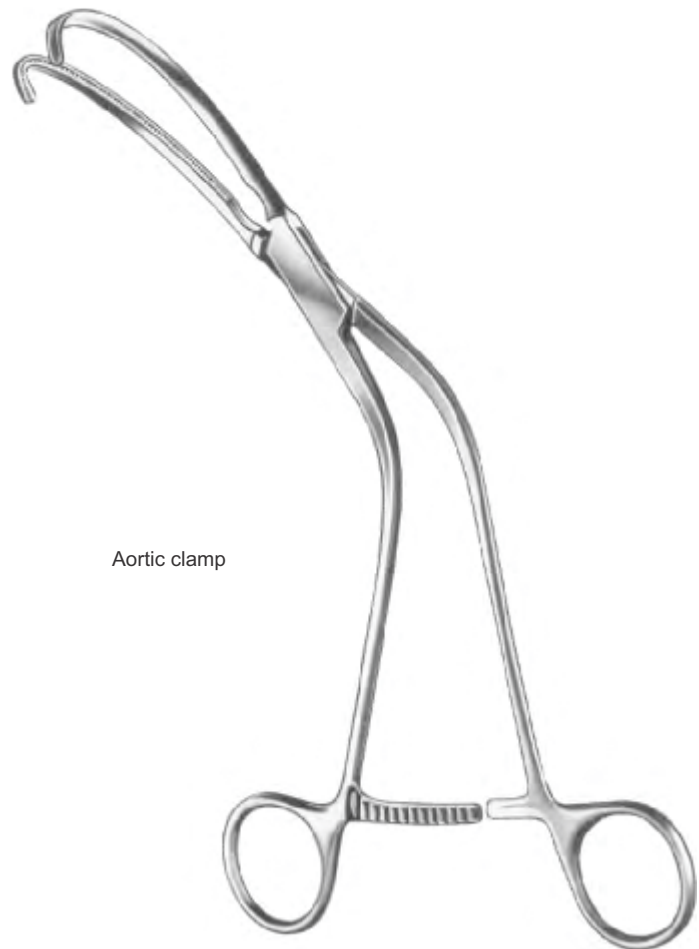

Aortic clamp

De Bakey-Semb

Weber
26 cm/10¼"



Satinsky/De Bakey

Tangential occlusion clamps



De Bakey

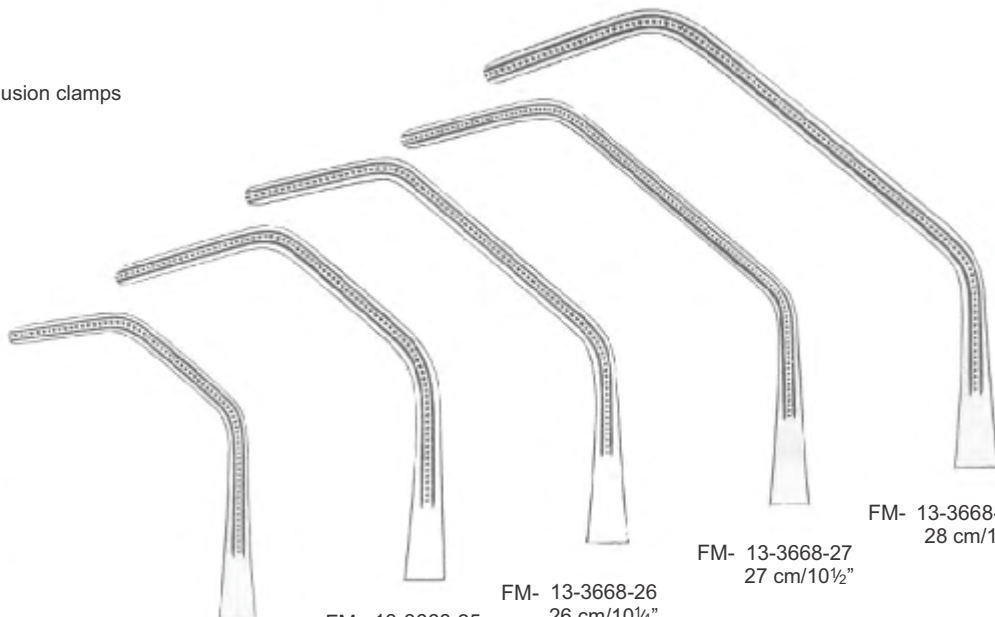

Set of 5 purchase. FM- 13-3668-00 20 cm/8"

FM- 13-3668-25 25 cm/10"

FM- 13-3668-26 26 cm/10 1/4"

FM- 13-3668-27 27 cm/10 1/2"

FM- 13-3668-28 28 cm/11"



Glover

FM- 13-3669-01 19.5 cm/7 3/4
 FM- 13-3669-02 21.0 cm/8 1/4

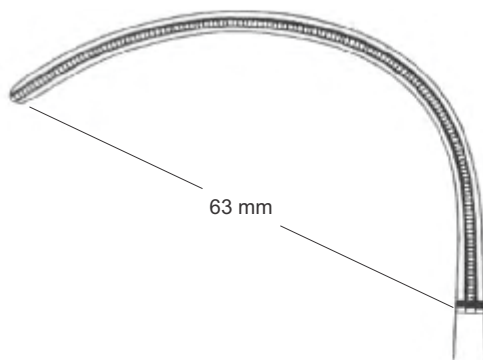

Anastomosis

63 mm

FM- 13-3669-01

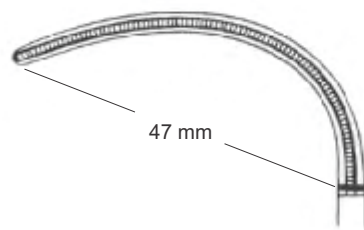

47 mm

FM- 13-3669-02



De Bakey

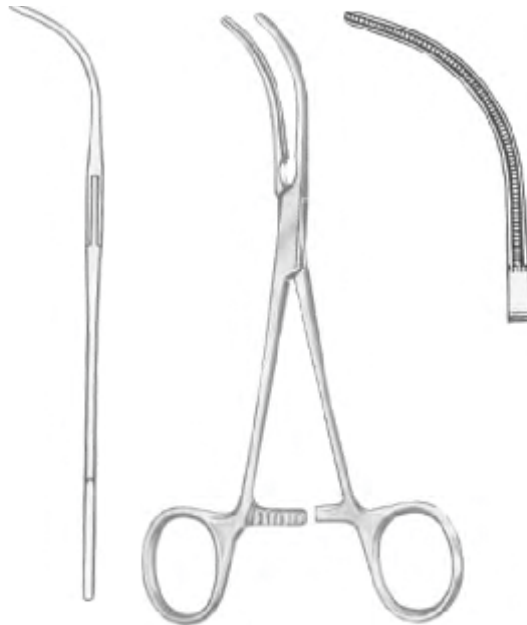

De Bakey
FM- 13-3670-16
16 cm/6 1/4"

Graduated

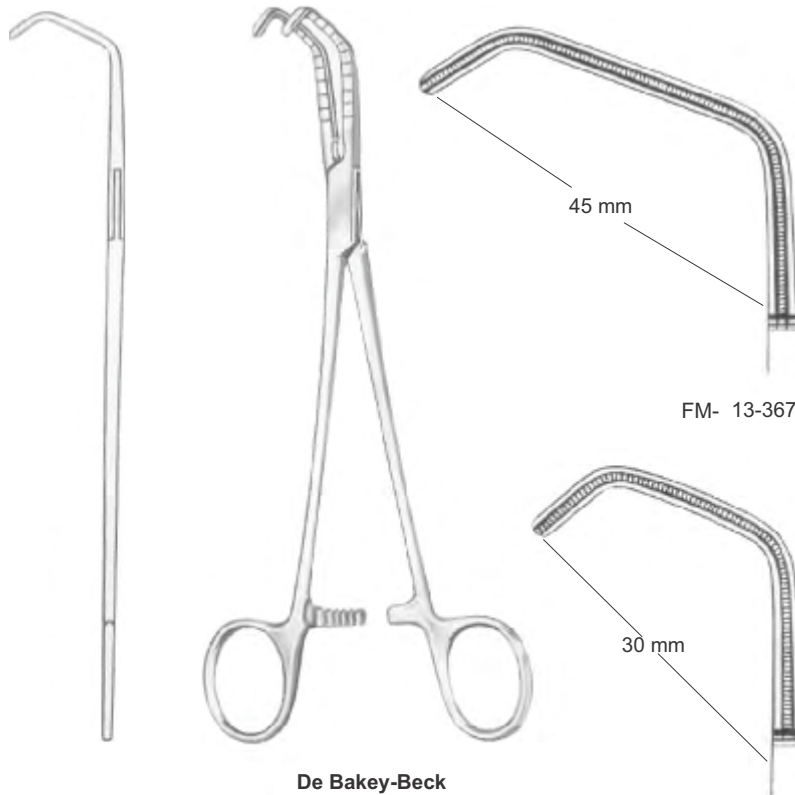

FM- 13-3671-02

De Bakey-Beck
FM- 13-3671-01 20.5 cm/8"
FM- 13-3671-02 21.0 cm/8 1/4"

FM- 13-3671-01

CARDIOVASCULAR



De Bakey



Lambert-Kay
21 cm/8¼"

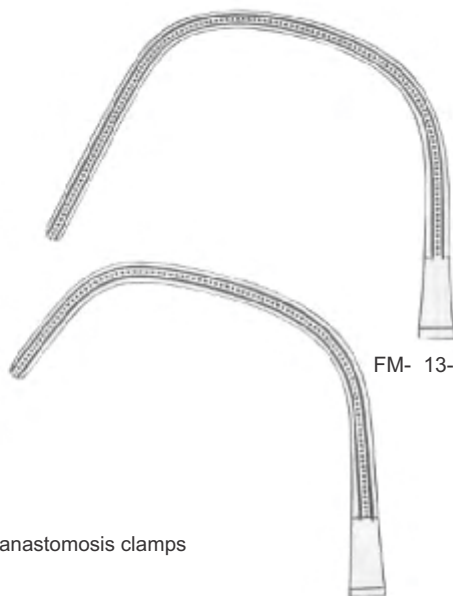

Aortic anastomosis clamps

FM- 13-3672-22

FM- 13-3672-21



De Bakey
FM- 13-3673-17
17 cm/6¾"



Beck
FM- 13-3674-17
17 cm/6¾"

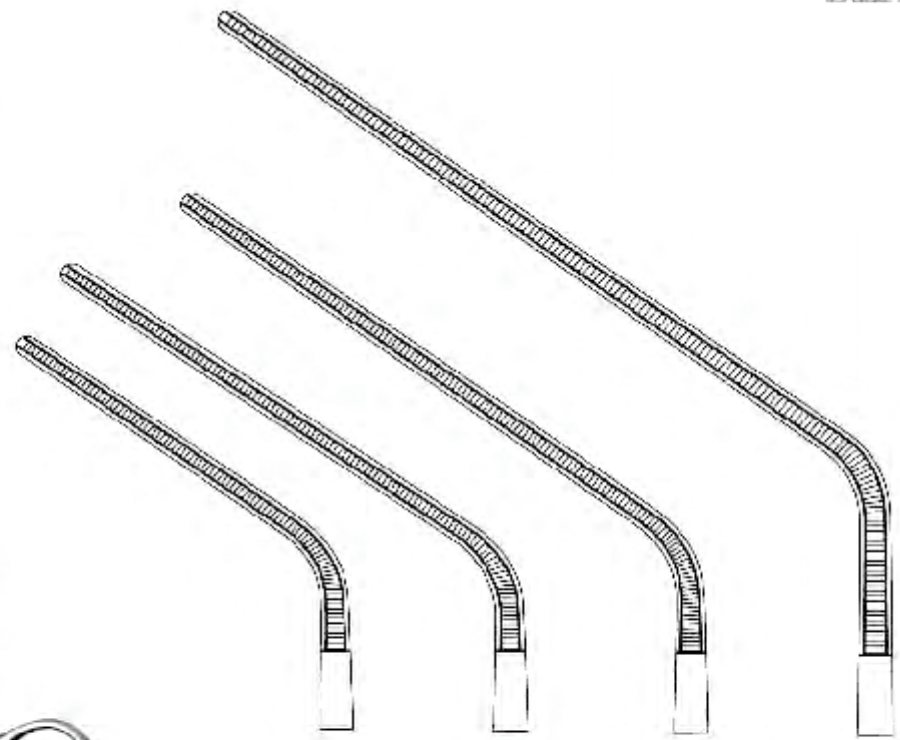

FM- 13-3675-20 20 cm/8"	FM- 13-3675-22 22 cm/8 3/4"	FM- 13-3675-24 24 cm/9 1/2"	FM- 13-3675-30 30.5 cm/12"
----------------------------	--------------------------------	--------------------------------	-------------------------------

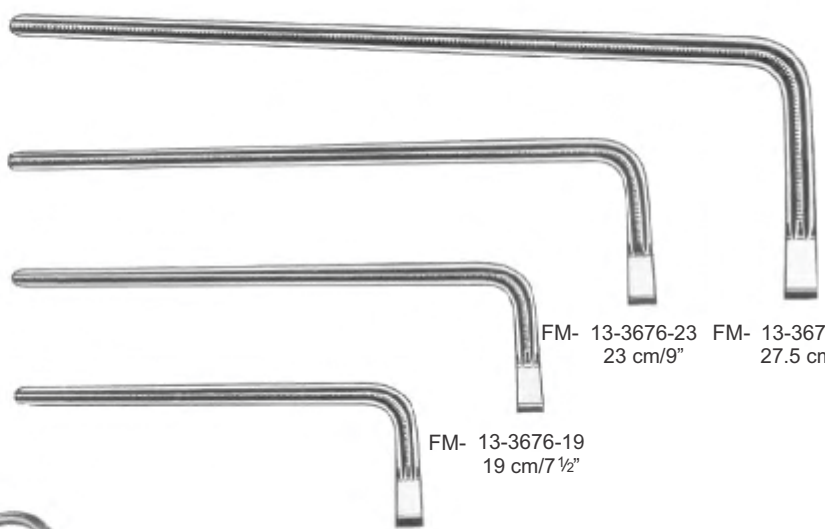
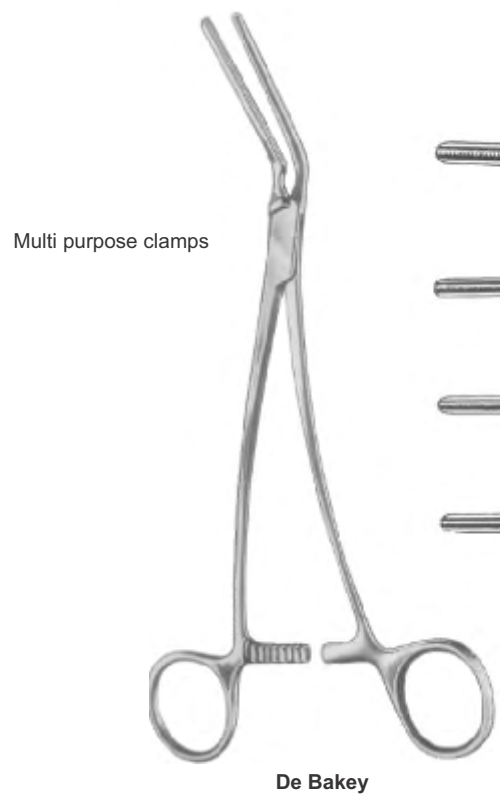

FM- 13-3676-18 18 cm/7"	FM- 13-3676-19 19 cm/7 1/2"	FM- 13-3676-23 23 cm/9"	FM- 13-3676-27 27.5 cm/11"
----------------------------	--------------------------------	----------------------------	-------------------------------

CARDIOVASCULAR



Aortic anastomosis clamps

Morris-De Bakey

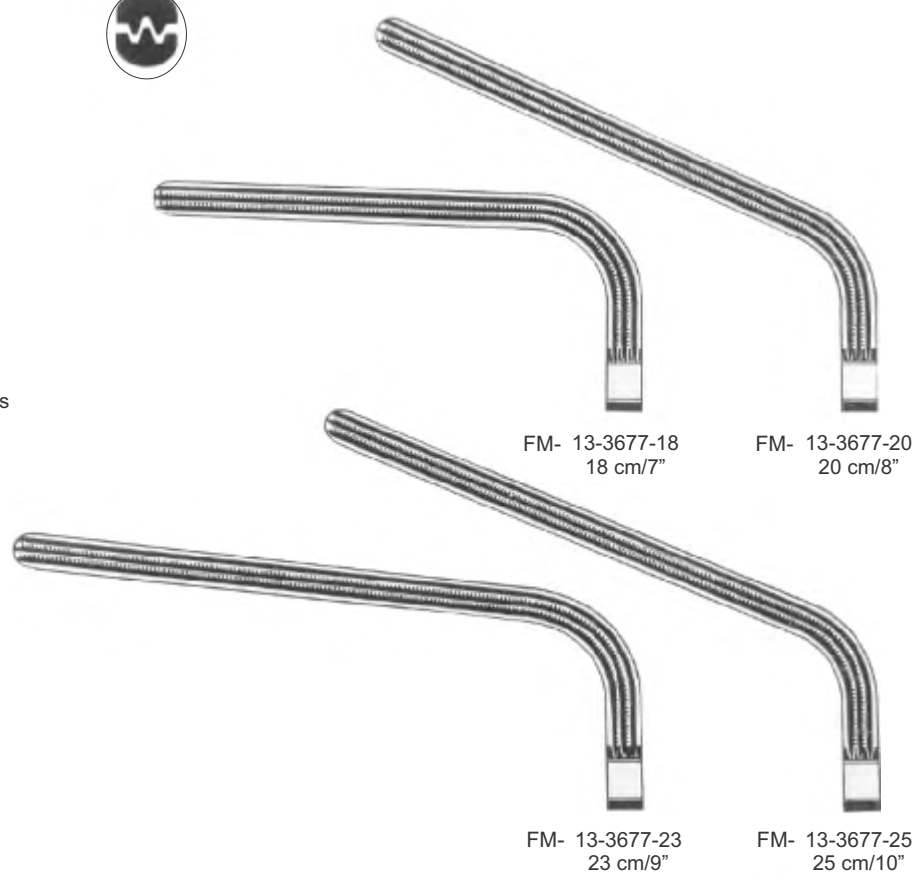

FM- 13-3677-18
 18 cm/7"

FM- 13-3677-20
 20 cm/8"

FM- 13-3677-23
 23 cm/9"

FM- 13-3677-25
 25 cm/10"



DE BAKEY-PEAN

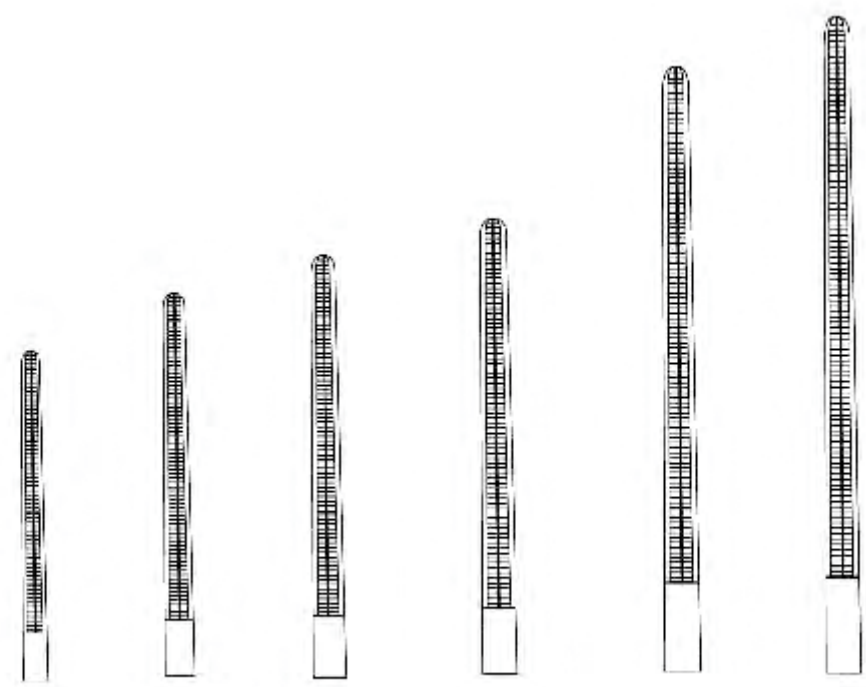

FM- 13-3678-14
 14.0cm

FM- 13-3678-16
 16.0cm

FM- 13-3678-18
 18.0cm

FM- 13-3678-20
 20.0cm

FM- 13-3678-26
 26.0cm

FM- 13-3678-28
 28.0cm

Aorta aneurysm clamps



De Bakey



De Bakey-Bahnson



FM- 13-3679-23
23 cm/9"



FM- 13-3679-24
24 cm/9½"



FM- 13-3679-25
25 cm/10"



DE BAKEY-PEAN



FM- 13-3680 14
14.0cm



FM- 13-3680 16
16.0cm



FM- 13-3680 18
18.0cm



FM- 13-3680 20
20.0cm



FM- 13-3680-26
26.0cm

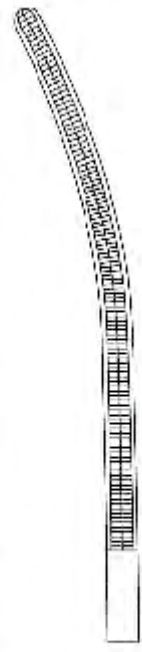

FM- 13-3680 28
28.0cm

Multi purpose clamps



De Bakey



De Bakey-Rankin

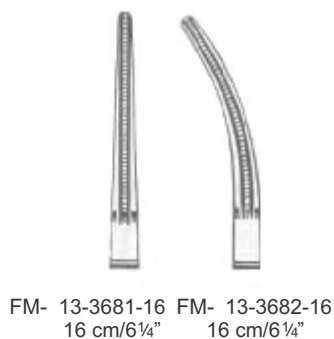

FM- 13-3681-16 16 cm/6¼"
 FM- 13-3682-16 16 cm/6¼"



Cooley

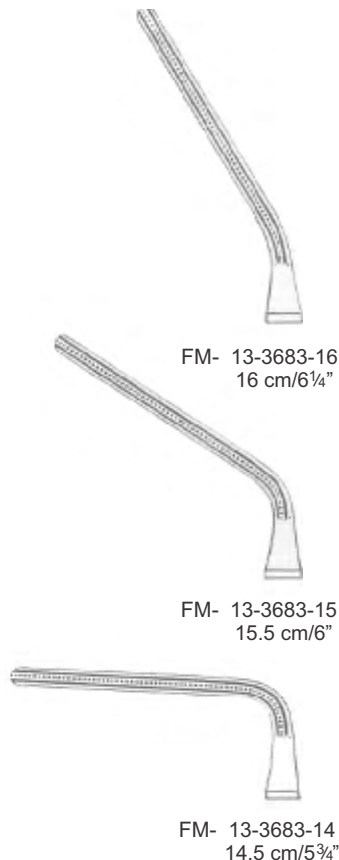

FM- 13-3683-16
 16 cm/6¼"

FM- 13-3683-15
 15.5 cm/6"

FM- 13-3683-14
 14.5 cm/5¾"



De Bakey
 FM- 13-3684-17
 17 cm/6¾"



FM- 13-3685-17



FM- 13-3686-17



FM- 13-3687-17



De Bakey

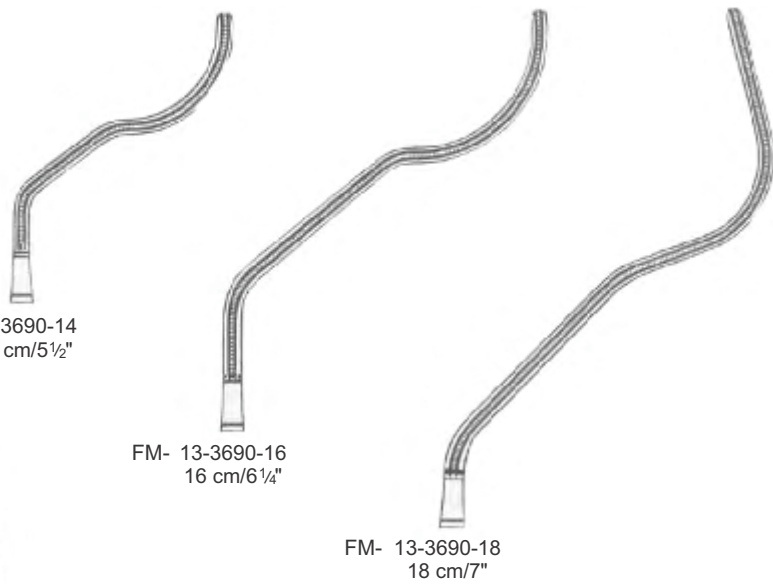
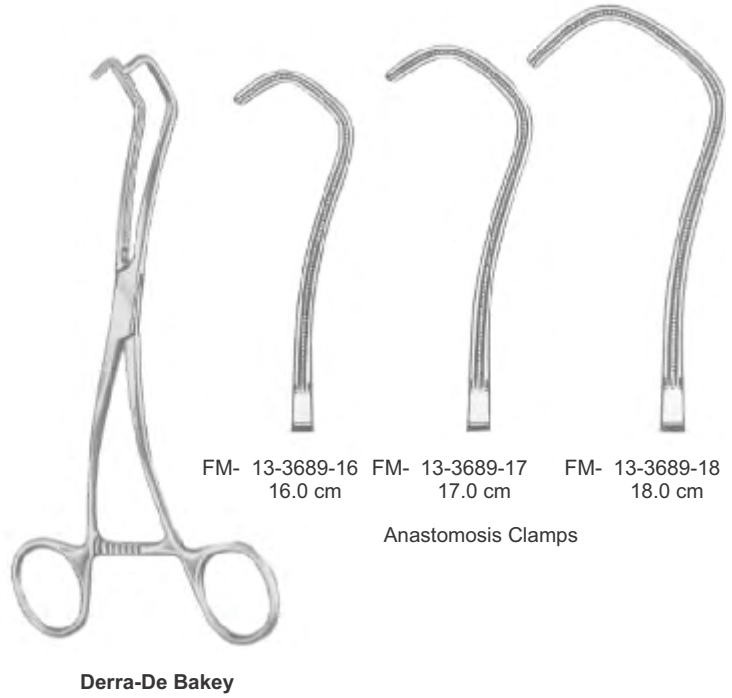
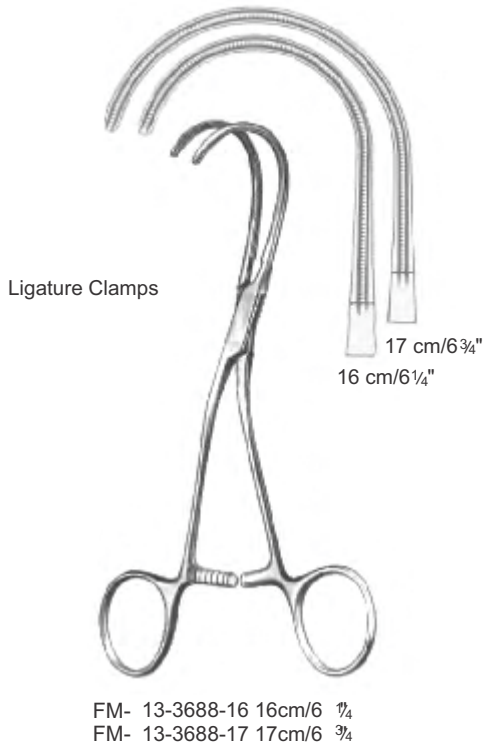

- EN Atrauma Cardiovascular Forceps
- DE Atrauma cardiovascular-klemmen
- ES Atrauma pinzas-clamps cardiovasculares
- FR Pince cardiovasculaire Atrauma
- IT Pinza cardiovascolare Atrauma



Cooley



Cooley
FM- 13-3695-20
20 cm/8"



Cooley

Cooley
FM- 13-3699-17
17 cm/6¾"



FM- 13-3696-03
17 cm/6¾"



FM- 13-3696-02
15.5 cm/6"



FM- 13-3696-01
15 cm/6"





Cooley

Anastomosis clamps



Cooley



FM- 13-3700-01
16.5 cm/6½"

FM- 13-3700-02
16.5 cm/6½"

FM- 13-3700-03
17.5 cm/7"

FM- 13-3700-04
17.5 cm/7"



Cooley
FM- 13-3701-16
16 cm/6¼"



Beck
FM- 13-3702-17
17 cm/6¾"

- EN Atrauma Cardiovascular Forceps
- DE Atrauma cardiovascular-klemmen
- ES Atrauma pinzas-clamps cardiovasculares
- FR Pince cardiovasculaire Atrauma
- IT Pinza cardiovascolare Atrauma



Cooley



Cooley-Derra

FM- 13-3703-16
16 cm/6 1/4"



FM- 13-3703-17
17 cm/6 3/4"



FM- 13-3703-18
18 cm/7"



Cooley

FM- 13-3704-16 16 cm/6 1/4"
FM- 13-3704-17 17 cm/6 3/4"



Ligature clamps

17 cm/6 3/4"
16 cm/6 1/4"

Atrauma Cardiovascular Forceps	EN
Atrauma cardiovascular-klemmen	DE
Atrauma pinzas-clamps cardiovasculares	ES
Pince cardiovasculaire Atrauma	FR
Pinza cardiovascolare Atrauma	IT

13



CARDIOVASCULAR



Cooley
14 cm/5½"



FM- 13-3705-14 FM- 13-3706-14



Cooley
FM- 13-3707-14
14 cm/5½"



Cooley
FM- 13-3708-14
14 cm/5½"

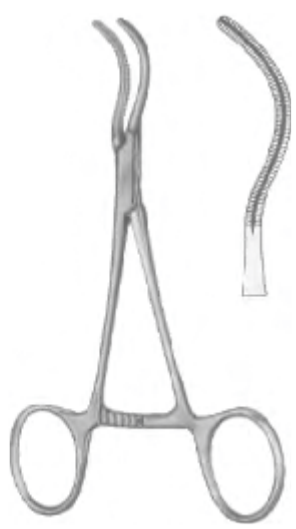

Cooley
FM- 13-3709-14
14 cm/5½"

- EN Suction Tubes and Tourniquets
 DE Saugrohre und Tourniquets
 ES Los tubos de succión y torniquetes
 FR Tubes d'aspiration et tourniquets
 IT Tubi di aspirazione e lacci emostatici

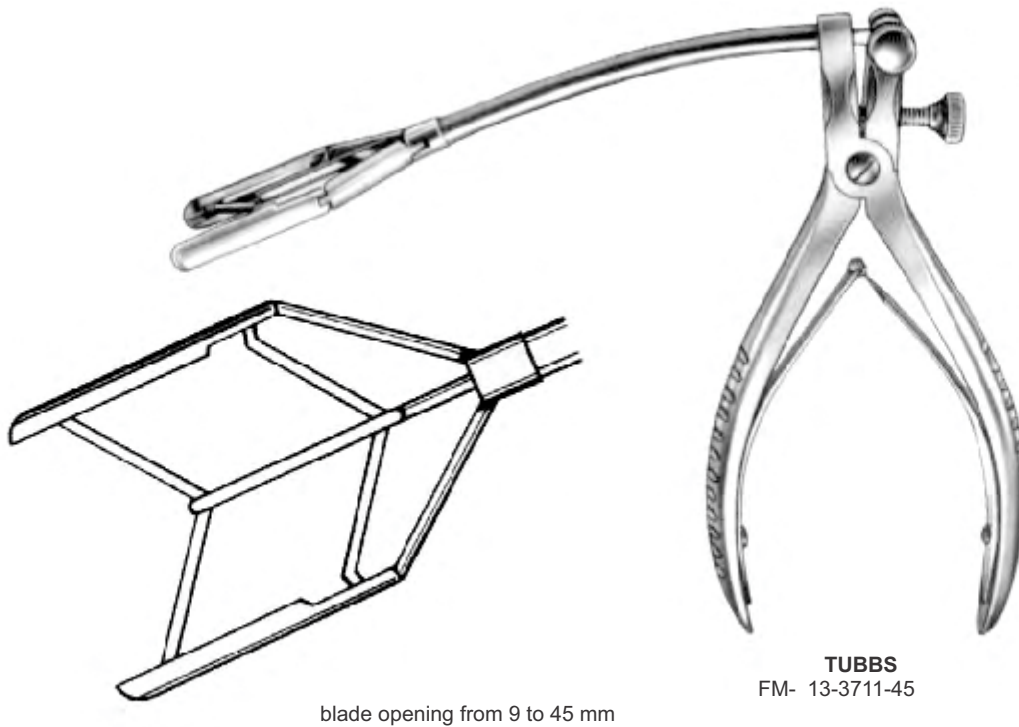

Dilators	EN
Dilatatoren	DE
Dilatadores	ES
Dilatateurs	FR
dilatatori	IT

13

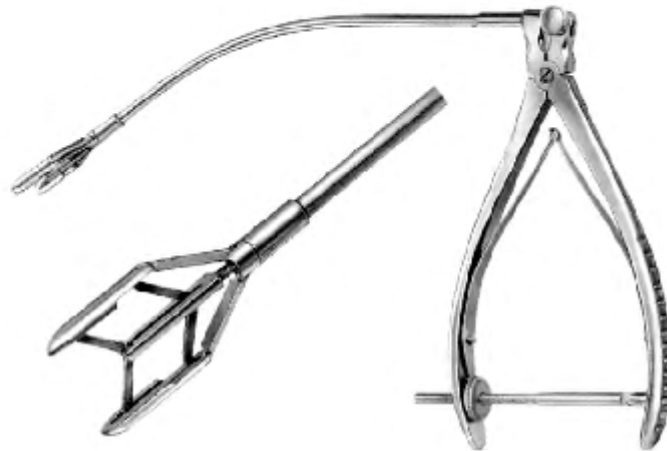

blade opening from 8 to 15 mm
blade opening from 8 to 45 mm

COOLEY
FM- 13-3712-15
FM- 13-3712-45

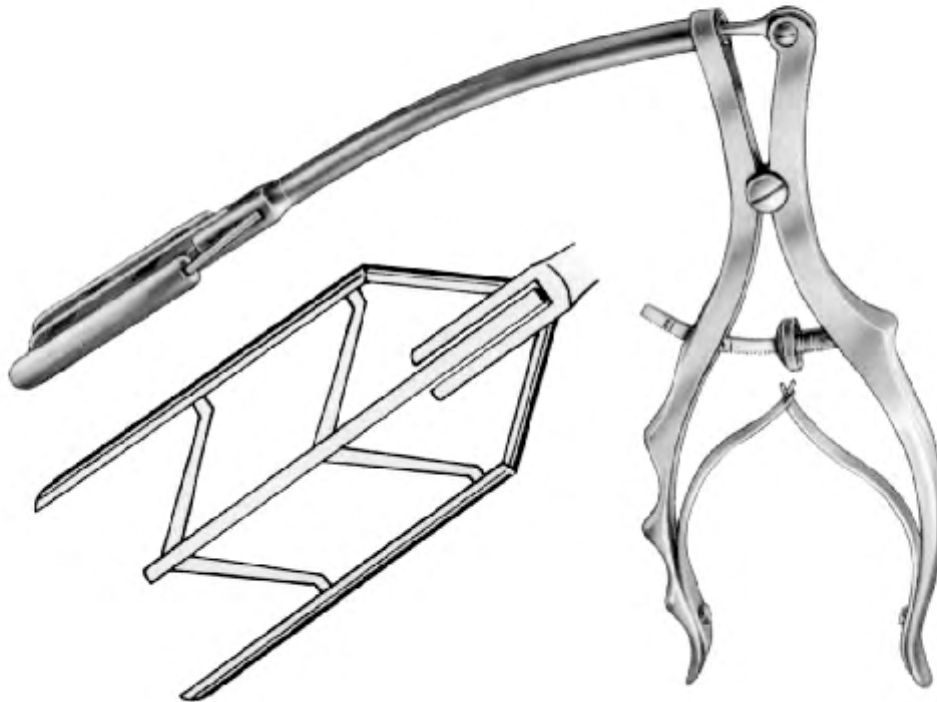

COOLEY
FM- 13-3713-40
blade opening 9 - 40mm

COOLEY-DEBAKEY
FM- 13-3714-30
blade opening 7 - 30mm

EN	Vascular Dilators
DE	Gefäß-Dilatatoren
ES	Dilatadores vasculares
FR	Dilatateurs vasculaires
IT	Dilatatori vascolari



CARDIOVASCULAR

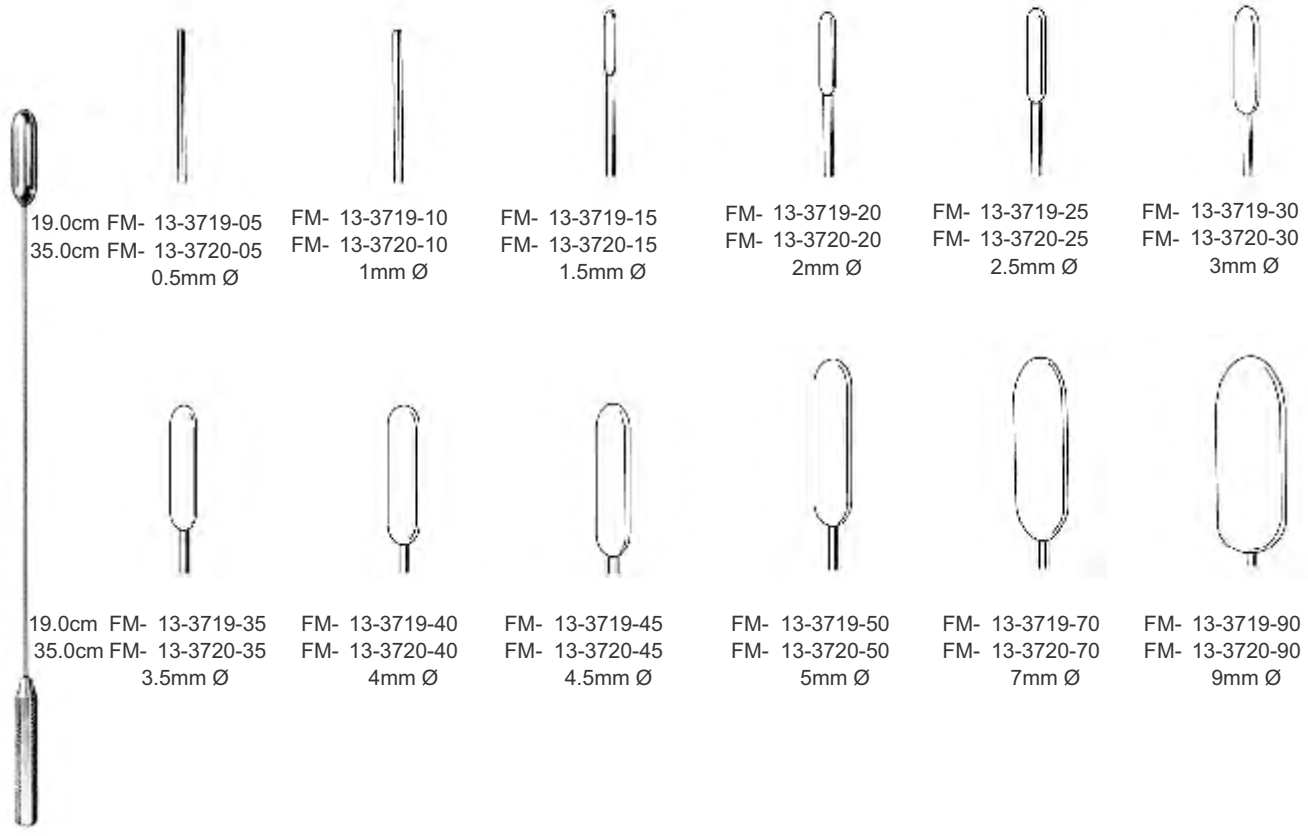

19.0cm FM- 13-3719-05	FM- 13-3719-10	FM- 13-3719-15	FM- 13-3719-20	FM- 13-3719-25	FM- 13-3719-30
35.0cm FM- 13-3720-05	FM- 13-3720-10	FM- 13-3720-15	FM- 13-3720-20	FM- 13-3720-25	FM- 13-3720-30
0.5mm Ø	1mm Ø	1.5mm Ø	2mm Ø	2.5mm Ø	3mm Ø
19.0cm FM- 13-3719-35	FM- 13-3719-40	FM- 13-3719-45	FM- 13-3719-50	FM- 13-3719-70	FM- 13-3719-90
35.0cm FM- 13-3720-35	FM- 13-3720-40	FM- 13-3720-45	FM- 13-3720-50	FM- 13-3720-70	FM- 13-3720-90
3.5mm Ø	4mm Ø	4.5mm Ø	5mm Ø	7mm Ø	9mm Ø

DE BAKEY

Malleable

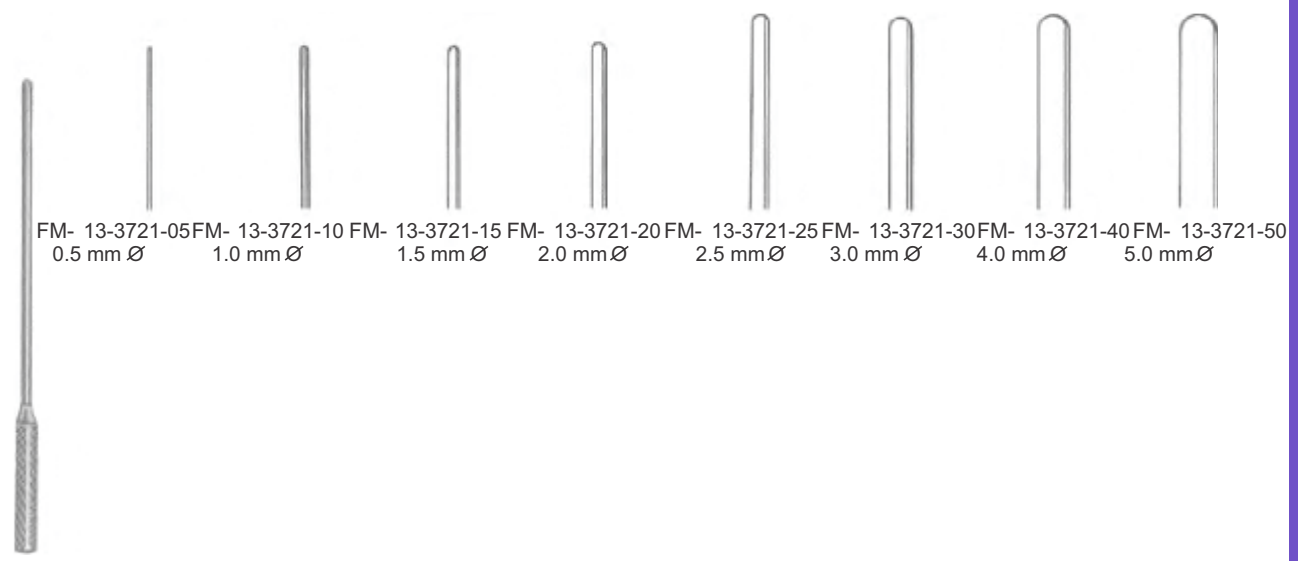

FM- 13-3721-05	FM- 13-3721-10	FM- 13-3721-15	FM- 13-3721-20	FM- 13-3721-25	FM- 13-3721-30	FM- 13-3721-40	FM- 13-3721-50
0.5 mm Ø	1.0 mm Ø	1.5 mm Ø	2.0 mm Ø	2.5 mm Ø	3.0 mm Ø	4.0 mm Ø	5.0 mm Ø

Cooley
13 cm/5"

Bone and Rib Shears **EN**
Knochen-und Rippenscheren **DE**
Cizallas para huesos **ES**
Cisailles à os et à côtes **FR**
Cesoie a osso e costola **IT**

13



FAIZAN & MUSA
SPECIAL INSTRUMENTS

CARDIOVASCULAR



SCHUMACHER
FM- 13-3734-20
20.0cm



TUDOR EDWARDS
FM- 13-3735-23
23.0cm

EN	Bone and Rib Shears
DE	Knochen-und Rippenscheren
ES	Cizallas para huesos
FR	Cisailles à os et à côtes
IT	Cesoie a osso e costola



LEBSCHE
FM- 13-3736-25
25.0cm

Rib Spreaders	EN
Rippensperrer	DE
Separadores costales	ES
Épandeurs de côtes	FR
Spargisale	IT

13



FAIZAN & MUSA
SPECIAL INSTRUMENTS

Scheme of dimensions

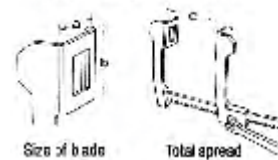

CASTAÑEDA			a	b	c
S/S	ALU				
FM- 13-3737-01	FM- 13-3737-11		10.5mm	32mm	65mm
FM- 13-3737-02	FM- 13-3737-12		16mm	30mm	65mm



CASTAÑEDA			a	b	c
S/S	ALU				
FM- 13-3738-01	FM- 13-3738-11		12mm	45mm	70mm



CASTAÑEDA			a	b	c
S/S	ALU				
FM- 13-3739-01	FM- 13-3739-11		15mm	60mm	120mm

EN	Bone and Rib Shears
DE	Knochen-und Rippenscheren
ES	Cizallas para huesos
FR	Cisailles à os et à côtes
IT	Cesoie a osso e costola



COOLEY				
S/S	ALU	a	b	c
FM- 13-3740-01	FM- 13-3740-11	12mm	16mm	95mm
FM- 13-3740-02	FM- 13-3740-12	12mm	17mm	75mm
FM- 13-3740-03	FM- 13-3740-13	14mm	16mm	85mm



COOLEY				
S/S	ALU	a	b	c
FM- 13-3741-01	FM- 13-3741-11	15mm	30mm	115mm
FM- 13-3741-02	FM- 13-3741-12	15mm	30mm	140mm
FM- 13-3741-03	FM- 13-3741-13	16mm	30mm	105mm
FM- 13-3741-04	FM- 13-3741-14	20mm	45mm	140mm
FM- 13-3741-05	FM- 13-3741-15	21mm	44mm	150mm
FM- 13-3741-06	FM- 13-3741-16	30mm	35mm	140mm

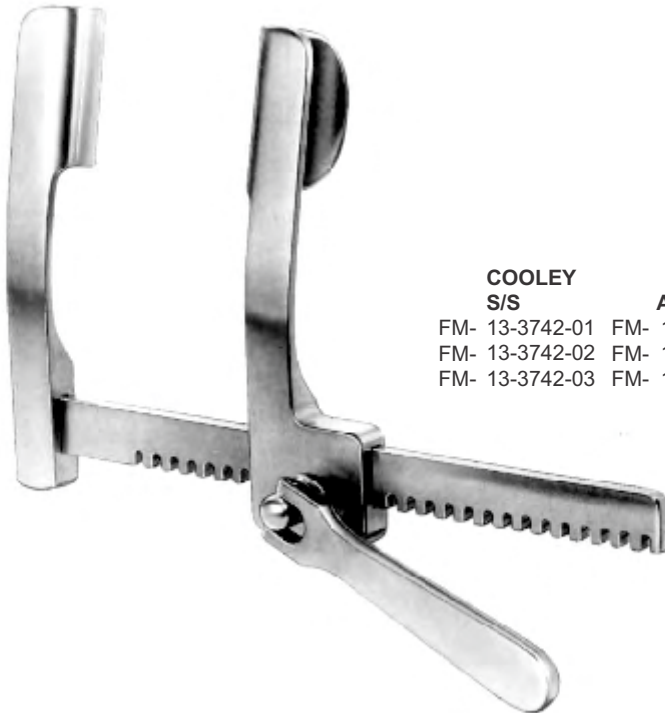

COOLEY				
S/S	ALU	a	b	c
FM- 13-3742-01	FM- 13-3742-11	30mm	50mm	185mm
FM- 13-3742-02	FM- 13-3742-12	35mm	50mm	200mm
FM- 13-3742-03	FM- 13-3742-13	37mm	49mm	200mm



COOLEY
for neonatal
S/S ALU a b c
FM- 13-3743-01 FM- 13-3743-11 12mm 15mm 70mm



COOLEY
infant, sternal spreader
S/S ALU a b c
FM- 13-3744-01 FM- 13-3744-11 15mm 20mm 100mm



COOLEY
for babies
S/S ALU a b c
FM- 13-3745-01 FM- 13-3746-01 20mm 25mm 80mm

EN	Rib Spreaders
DE	Rippensperrer
ES	Separadores costales
FR	Épandeurs de côtes
IT	Spargisale

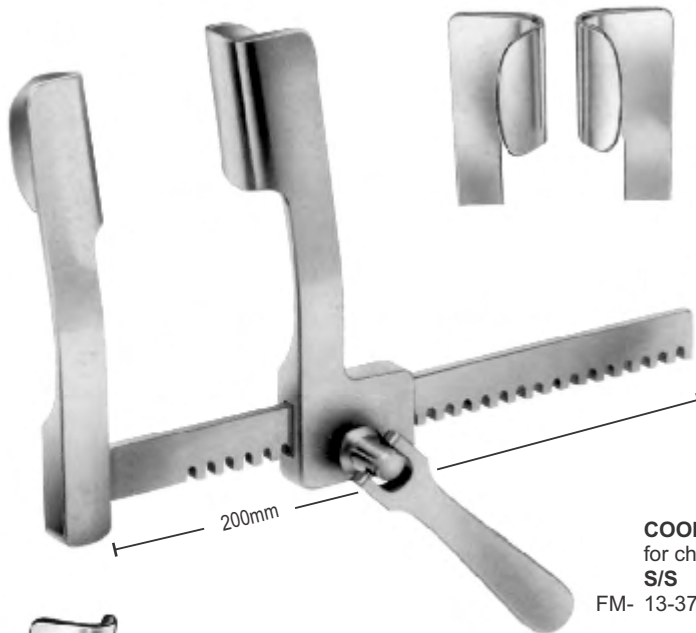

COOLEY
for children

S/S	ALU	a	b	c
FM- 13-3747-01	FM- 13-3748-01	21mm	45mm	145mm
for adult				
FM- 13-3747-02	FM- 13-3748-02	32mm	50mm	190mm



COOLEY
for children

S/S	ALU	a	b	c
FM- 13-3749-01	FM- 13-3750-01	35mm	100mm	180mm
for adult				
FM- 13-3749-02	FM- 13-3750-02	35mm	115mm	230mm



COOLEY
for adults with suture separator

S/S	ALU	a	b	c
FM- 13-3751-01	FM- 13-3752-01	35mm	100mm	180mm

Rib Spreaders	EN
Rippensperrer	DE
Separadores costales	ES
Épandeurs de côtes	FR
Spargisale	IT

13



CARDIOVASCULAR



H-COOLEY
with swivel convex blades, for babies
S/S ALU a b c
FM- 13-3753-01 FM- 13-3754-01 10mm 15mm 90mm



H-COOLEY
with swivel blades, for babies
S/S ALU a b c
FM- 13-3755-02 FM- 13-3756-02 10mm 15mm 90mm

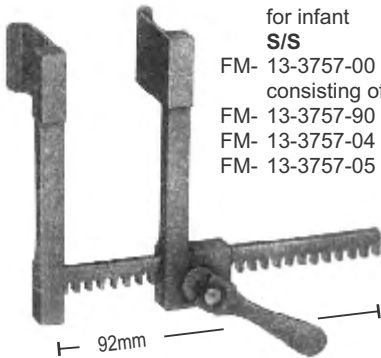

STRUCK
for infant
S/S ALU
FM- 13-3757-00 FM- 13-3757-01
consisting of
FM- 13-3757-90 spreader only
FM- 13-3757-04 1 pair
FM- 13-3757-05 1 pair

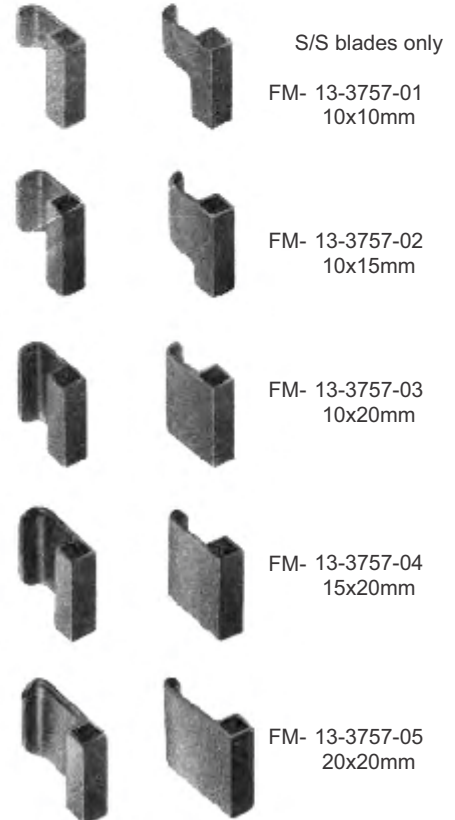

EN Rib Spreaders

DE Rippensperrer

ES Separadores costales

FR Épandeurs de côtes

IT Spargisale



WEINBERG
for children
S/S ALU a b c
FM- 13-3758-01 FM- 13-3759-01 12mm 20mm 95mm

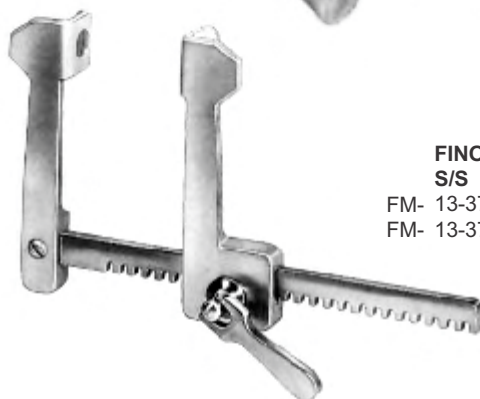

FINOCHIETTO-INFANT
S/S ALU a b c
FM- 13-3760-01 FM- 13-3761-01 12mm 15mm 70mm
FM- 13-3760-02 FM- 13-3761-02 15mm 15mm 75mm

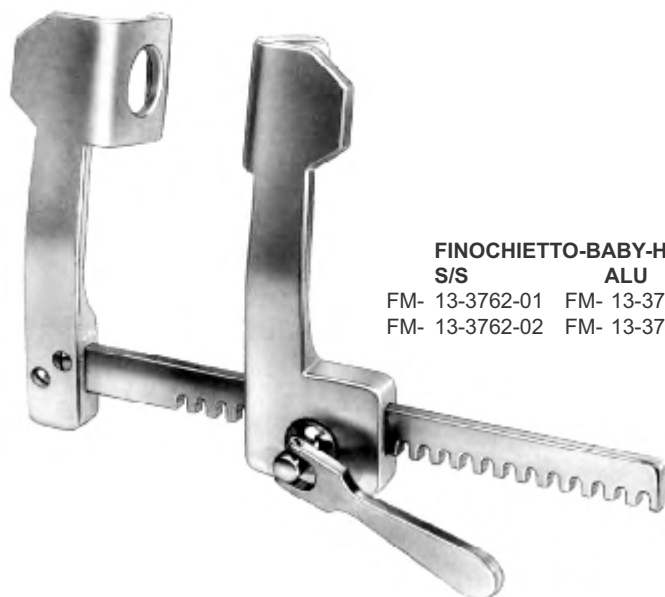

FINOCHIETTO-BABY-HAIGHT
S/S ALU a b c
FM- 13-3762-01 FM- 13-3763-01 27mm 30mm 95mm
FM- 13-3762-02 FM- 13-3763-02 31mm 31mm 100mm

Rib Spreaders	EN
Rippensperrer	DE
Separadores costales	ES
Épandeurs de côtes	FR
Spargisale	IT

13

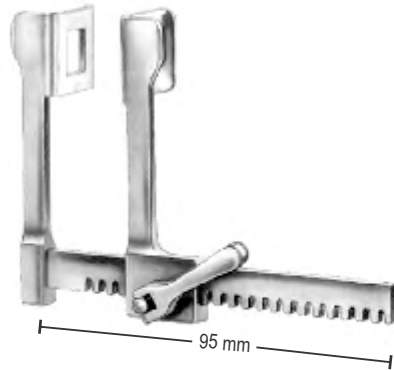

FINOCHIETTO-BABY		a	b	c
S/S	ALU			
FM- 13-3764-01	FM- 13-3765-01	14mm	15mm	75mm
FM- 13-3764-02	FM- 13-3765-02	18mm	20mm	75mm

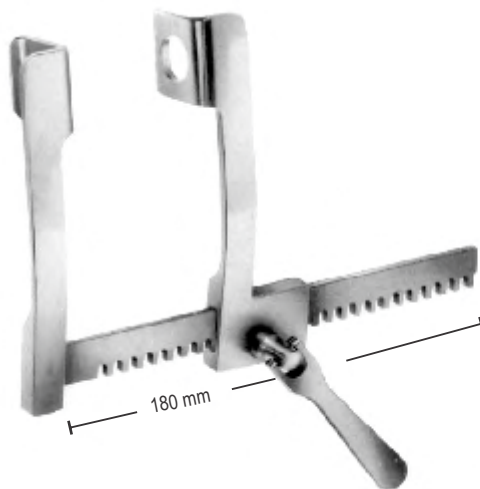

S/S	ALU	a	b	c
FM- 13-3766-01	FM- 13-3767-01	28mm	32mm	120mm



FINOCHIETTO		a	b	c
S/S	ALU			
FM- 13-3768-01	FM- 13-3769-01	12mm	15mm	100mm
FM- 13-3768-02	FM- 13-3769-02	28mm	30mm	143mm
FM- 13-3768-03	FM- 13-3769-03	31mm	45mm	210mm
FM- 13-3768-04	FM- 13-3769-04	42mm	61mm	245mm
FM- 13-3768-05	FM- 13-3769-05	74mm	64mm	245mm

EN Rib Spreaders

DE Rippensperrer

ES Separadores costales

FR Épandeurs de côtes

IT Spargisale

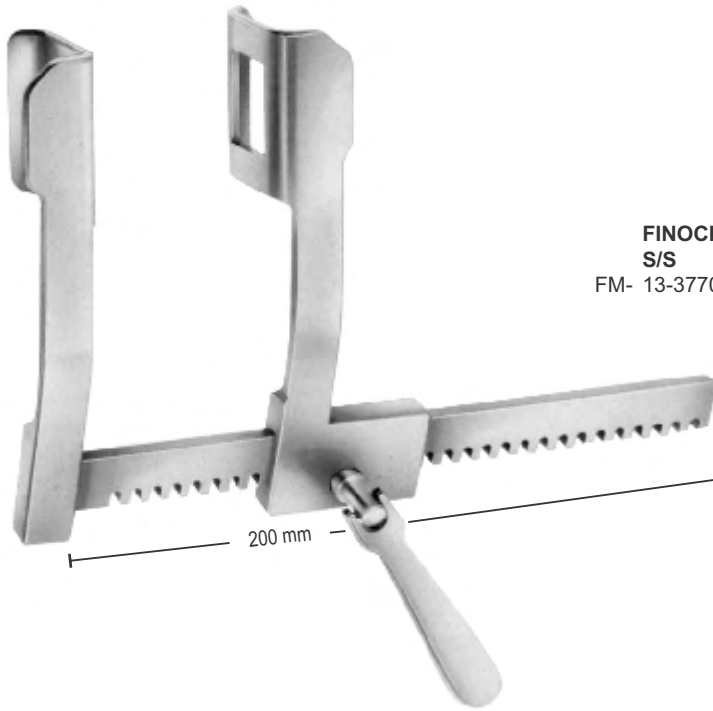
FAIZAN & MUSA
SPECIAL INSTRUMENTS
**FINOCHIETTO****S/S****ALU****a****b****c**

FM- 13-3770-01

FM- 13-3771-01

36mm

45mm

140mm

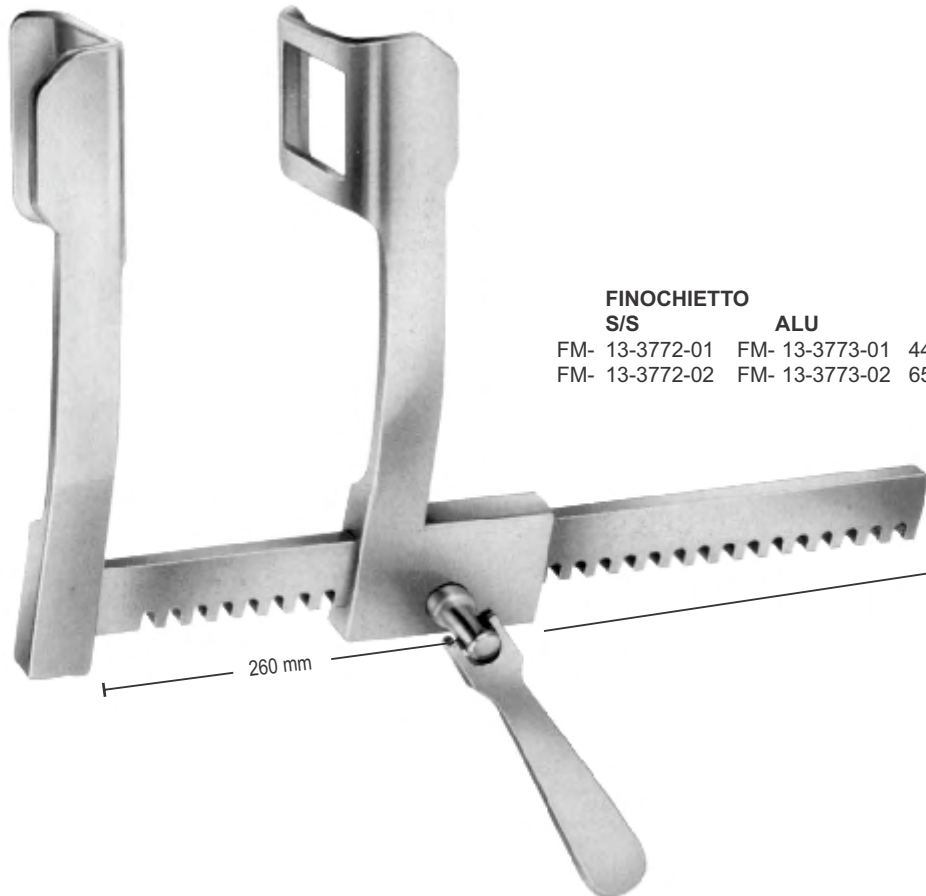
**FINOCHIETTO****S/S****ALU****a****b****c**

FM- 13-3772-01

FM- 13-3773-01

44mm

65mm

210mm

FM- 13-3772-02

FM- 13-3773-02

65mm

65mm

210mm

- EN** Tonsil
- DE** Mandel
- ES** Amígdala
- FR** Amygdale
- IT** Tonsilla

Page 186 to 196

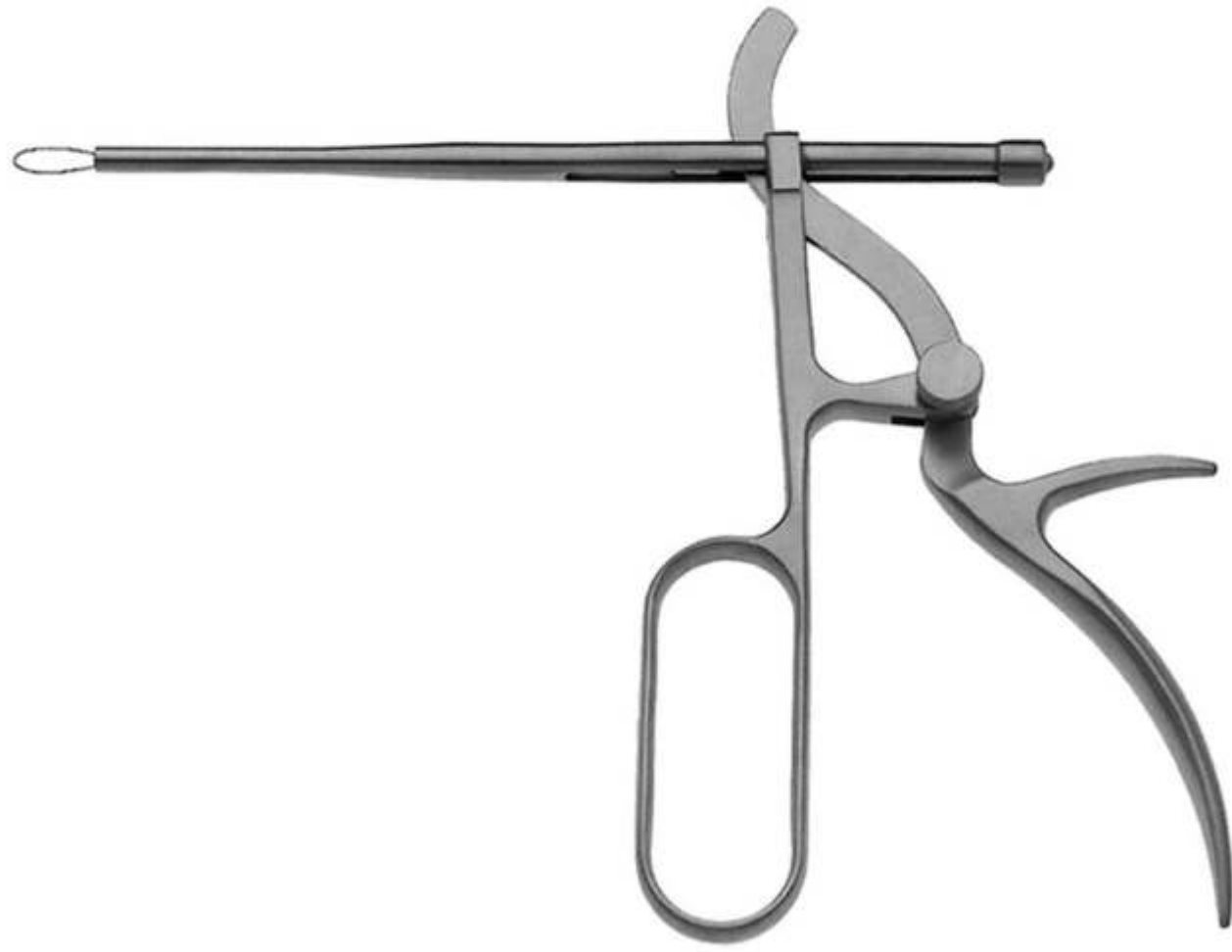



2.5 mm



Luniatschek
 FM- 14-3951-19
 19 cm



1.8 mm



Luniatschek
 FM- 14-3952-19
 19 cm

Gauze Packers



Luniatschek
 FM- 14-3951-19
 19 cm



Luniatschek
 FM- 14-3952-19
 19 cm



Day
 FM- 14-3953-21
 21.5 cm



Hurd
 FM- 14-3954-01
 21 cm



Hurd
 FM- 14-3954-02
 21 cm



Nager
 FM- 14-3955-24
 24 cm/9½"



Falk
 FM- 14-3956-24
 24 cm/9½"



Falk
 FM- 14-3957-24
 24 cm/9½"



Claus-Eicken
 FM- 14-3958-23
 23 cm/9"



DURHAM
 FM- 14-3959-01 25.0cm FM- 14-3959-02





FAIZAN & MUSA
SPECIAL INSTRUMENTS

14

Cleft Palate knives and tonsil knives	EN
Nadeln zur gaumennaht, Tonsillennadeln	DE
Agujas para suturas del paladar	ES
Couteaux Cleft Palate et couteaux aux amygdales	FR
Coltelli da palatoschisi e coltelli tonsillari	IT

TONSIL

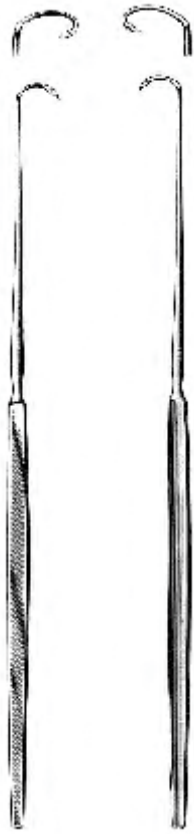

ROTTER
FM- 14-3960-01 26.0cm FM- 14-3960-02



Fischer
FM- 14-3961-22
22.5 cm/8 7/8"



Douglas
FM- 14-3962-21
21 cm/8 1/4"



Abraham
FM- 14-3963-21
21 cm/8 1/4"



Bruenings
FM- 14-3964-23
23 cm/9"



Tydins
FM- 14-3965-21
21 cm



Can eld
FM- 14-3966-21
21 cm/8 1/4"

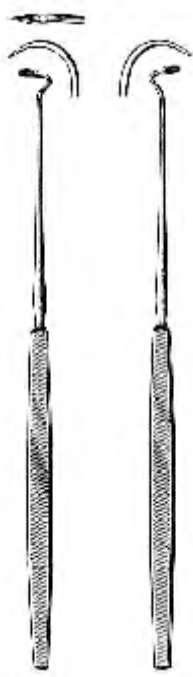

Colver
FM- 14-3967-22
22.5cm



Dupy-Weiss
FM- 14-3968-01 22.0cm FM- 14-3968-02



Lynch
FM- 14-3969-20
20.0cm

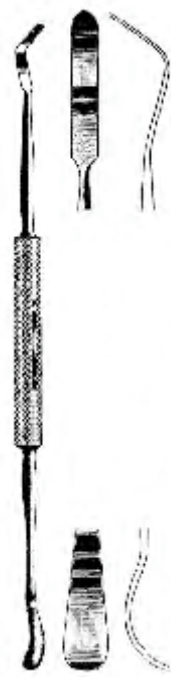

Carpenter
FM- 14-3970-25
25.0cm



Carpenter
FM- 14-3971-24
24.0cm



Marschik
FM- 14-3972-22
22.0cm

TONSIL



Negus Knot Tier and Pusher FM- 14-3973-20 20cm/8"
Molison Pillar double ended FM- 14-3974-21 21cm/8 1/4"
Gwynee Evans Dissector double ended FM- 14-3975-06 6mm, 20cm/8"
 FM- 14-3975-08 8mm, 20cm/8"
Hurd FM- 14-3976-22 22.5 cm/8 7/8"
Yankauer FM- 14-3977-21 21 cm/8 1/4"
 FM- 14-3978-01
Henke FM- 14-3978-02 23 cm/9"

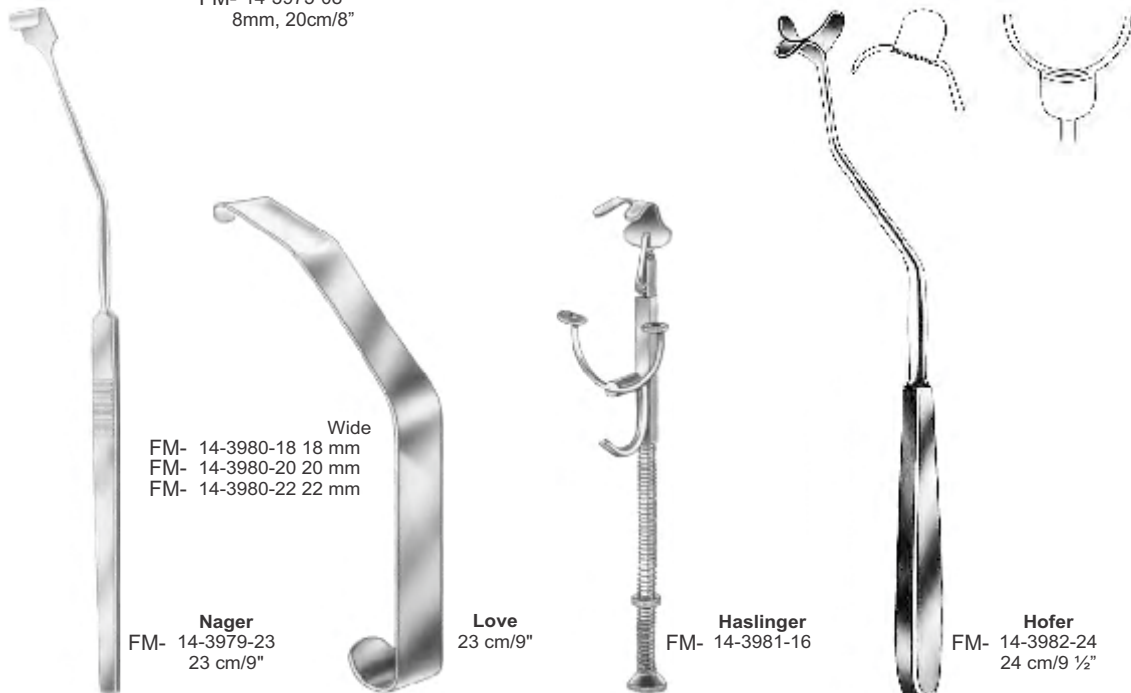

Nager FM- 14-3979-23 23 cm/9"
 Wide
 FM- 14-3980-18 18 mm
 FM- 14-3980-20 20 mm
 FM- 14-3980-22 22 mm
Love 23 cm/9"
Haslinger FM- 14-3981-16
Hofer FM- 14-3982-24 24 cm/9 1/2"

Tonsil Seizing Forceps **EN**

Tonsillenzangen **DE**

Pinzas para coger las amígdalas **ES**

Forceps de grippage des amygdales **FR**

Pinza per presa delle tonsille **IT**

14

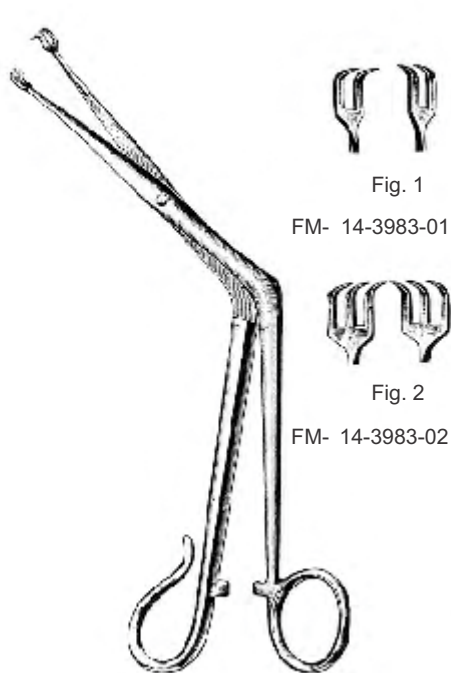

TIVNEN-TYDING
21.0cm



MUSEUX
FM- 14-3984-20
20.0cm



MUSEUX
FM- 14-3985-20
20.0cm



BALLENGER
FM- 14-3986-21
21.5cm



WHITE
FM- 14-3987-18 18.0cm
FM- 14-3987-23 23.0cm

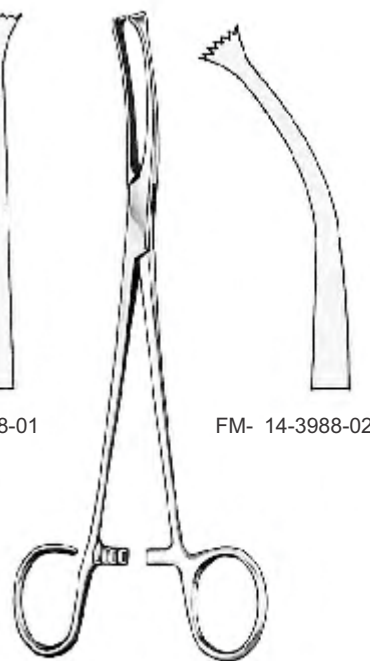

COLVER
19.0cm

- EN Tonsil Haemostatic and Abscess Holding Forceps
- DE Tonsil Haemostatic und Abszessbesitzzange
- ES La amigdala haemostatic yel absceso que tienen fórceps
- FR Tonsil hémostatique et abcès tenant pinces
- IT Pinza per presa emostatica e ascesso di tonsille

TONSIL

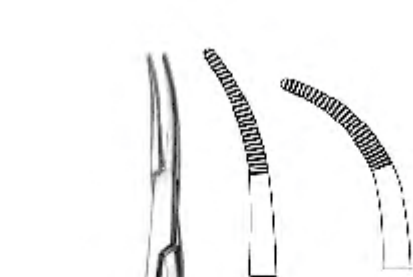

FM- 14-3989-01 FM- 14-3989-02



SCHNIDT
19.0cm



FM- 14-3990-01 FM- 14-3990-02



SCHNIDT
19.0cm



FM- 14-3991-20



BLOHMKE
20.0cm



DENIS-BROWNE
FM- 14-3992-18 18.0cm
FM- 14-3992-21 21.0cm

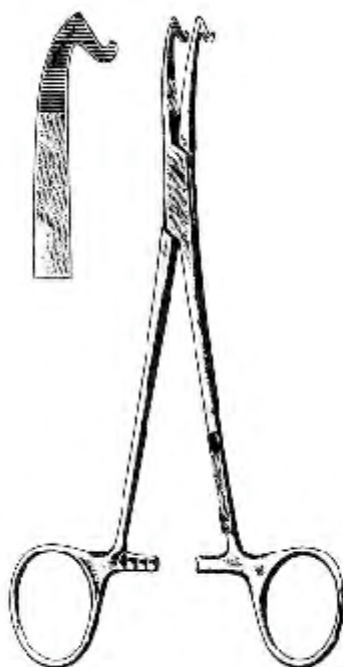

McWHORTER-LOTHROP
FM- 14-3993-18
18.0cm



THILENIUS
FM- 14-3994-20
20.0cm

Tonsil Seizing Forceps EN

Tonsillenzangen DE

Pinzas para coger las amígdalas ES

Forceps de grippage des amygdales FR

Pinza per presa delle tonsille IT

14



FAIZAN & MUSA
SPECIAL INSTRUMENTS

TONSIL

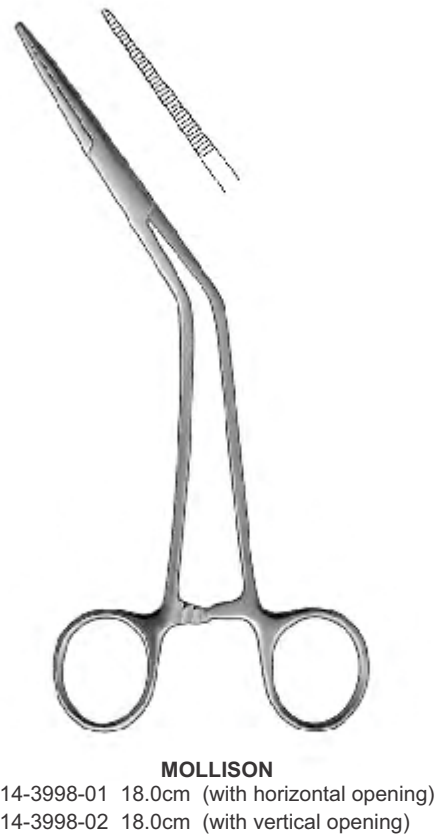
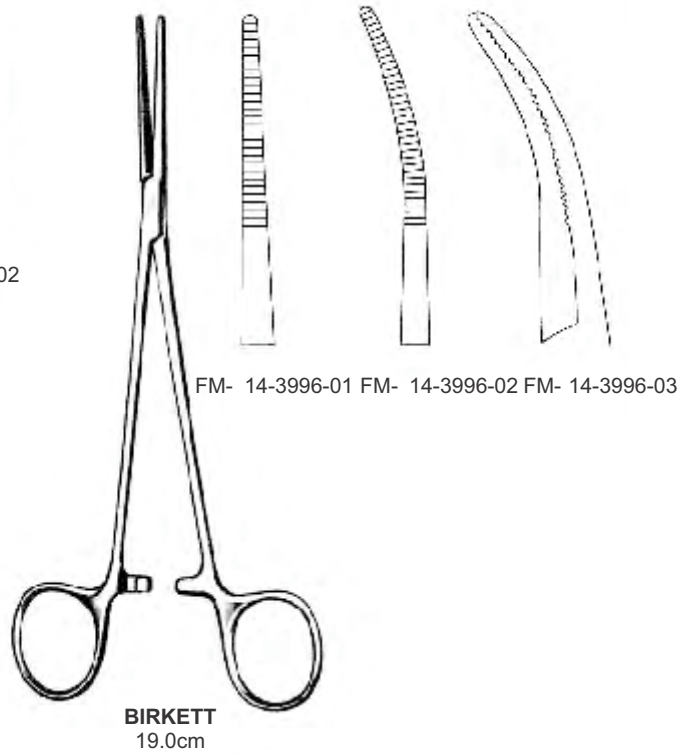
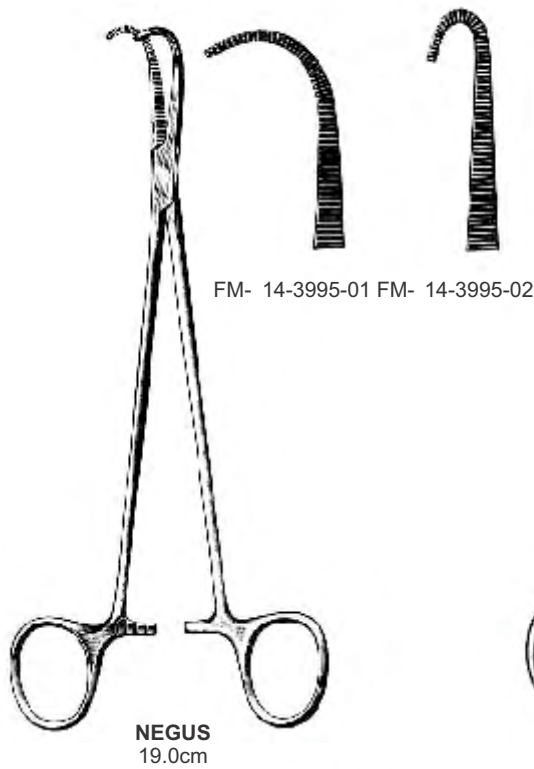

EN	Tonsil Snares
DE	Tonsillenschnürer
ES	Cierra-nudos para amígdalas
FR	Snare amygdales
IT	Tonsil Snares



Eves
FM- 14-3999-28
28 cm/11"



Eves
FM- 14-4000-28
28 cm/11"



Bruenings
FM- 14-4001-28
28 cm/11"

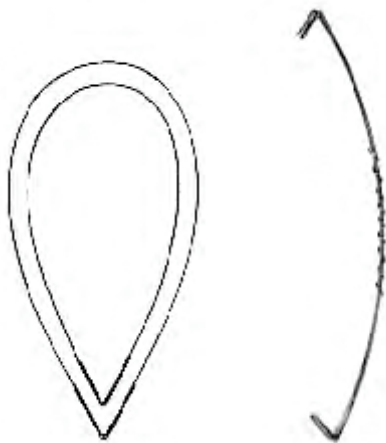

FM- 14-4002-40 40mm FM- 14-4003-03 0.3mm Ø
FM- 14-4002-50 50mm

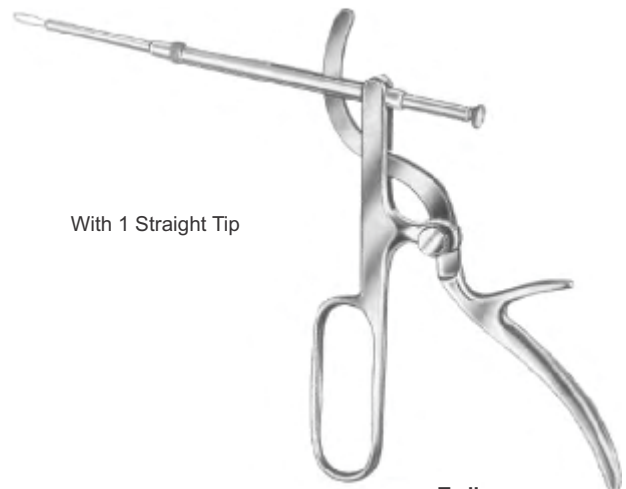

With 1 Straight Tip

Tyding
FM- 14-4004-00

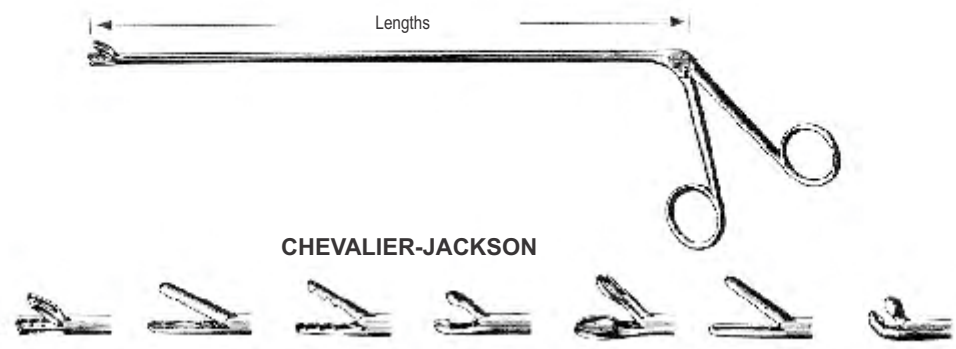

30.0cm FM- 14-4012-30	FM- 14-4013-30	FM- 14-4014-30	FM- 14-4015-30	FM- 14-4016-30	FM- 14-4017-30	FM- 14-4018-30
40.0cm FM- 14-4012-40	FM- 14-4013-40	FM- 14-4014-40	FM- 14-4015-40	FM- 14-4016-40	FM- 14-4017-40	FM- 14-4018-40
50.0cm FM- 14-4012-50	FM- 14-4013-50	FM- 14-4014-50	FM- 14-4015-50	FM- 14-4016-50	FM- 14-4017-50	FM- 14-4018-50
60.0cm FM- 14-4012-60	FM- 14-4013-60	FM- 14-4014-60	FM- 14-4015-60	FM- 14-4016-60	FM- 14-4017-60	FM- 14-4018-60



BRUENINGS (straight)
 FM- 14-4019-20 20.0cm
 FM- 14-4019-30 30.0cm
 FM- 14-4019-40 40.0cm
 FM- 14-4019-50 50.0cm
 FM- 14-4019-60 60.0cm

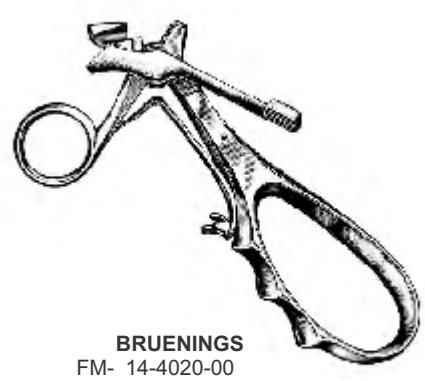

BRUENINGS
FM- 14-4021-20
20.0cm



FRAENKEL
 FM- 14-4022-00



BARACANI
 FM- 14-4023-00



SEIFFERT
 FM- 14-4024-00



FRAENKEL
 FM- 14-4025-00



BRUENINGS
 FM- 14-4026-01
 FM- 14-4026-02



BRUENINGS
 FM- 14-4027-01
 FM- 14-4027-02



LANGE
 FM- 14-4028-00



KRAUSE
 FM- 14-4029-01
 FM- 14-4029-02



SCHUMACHER
 FM- 14-4030-00



CORDES
 FM- 14-4031-01
 FM- 14-4031-02



CORDES
 FM- 14-4032-00



ROSENBERG
 FM- 14-4033-00



KRAUSE
 FM- 14-4034-00



CORDES
 FM- 14-4035-01
 FM- 14-4035-02
 FM- 14-4035-03
 FM- 14-4035-04



SCHEINMANN
 FM- 14-4036-00



SCHEINMANN
 FM- 14-4037-00



FM- 14-4038-11



FM- 14-4039-10



FM- 14-4040-11



FM- 14-4041-12



FM- 14-4042-00



MICHEL
25.0cm



FM- 14-4043-12 FM- 14-4043-14 FM- 14-4043-16 FM- 14-4043-18



FM- 14-4044-08
 FM- 14-4044-10
 FM- 14-4044-12
 FM- 14-4044-14
 FM- 14-4044-16
 FM- 14-4044-18
 FM- 14-4044-20
 FM- 14-4044-22
 FM- 14-4044-24
 FM- 14-4044-26
 FM- 14-4044-28
 FM- 14-4044-30

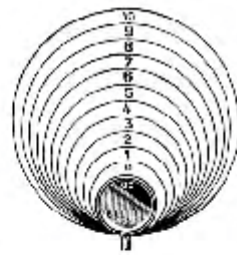

g.00, 8mm Ø
 g.0, 10mm Ø
 g.1, 12mm Ø
 g.2, 14mm Ø
 g.3, 16mm Ø
 g.4, 18mm Ø
 g.5, 20mm Ø
 g.6, 22mm Ø
 g.7, 24mm Ø
 g.8, 26mm Ø
 g.9, 28mm Ø
 g.10, 30mm Ø



FM- 14-4045-08
 FM- 14-4045-10
 FM- 14-4045-12
 FM- 14-4045-14
 FM- 14-4045-16
 FM- 14-4045-18
 FM- 14-4045-20
 FM- 14-4045-22
 FM- 14-4045-24
 FM- 14-4045-26
 FM- 14-4045-28
 FM- 14-4045-30

EN Laryngeal Polypus Forceps
 DE Kehlkopfpolypenzangen
 ES Pinzas para polipos laringeos
 FR Pince à polypes laryngés
 IT Forcipe del polipo laringeo



FM- 14-4046-01



FM- 14-4046-02



FM- 14-4046-03

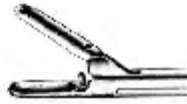

FM- 14-4046-04

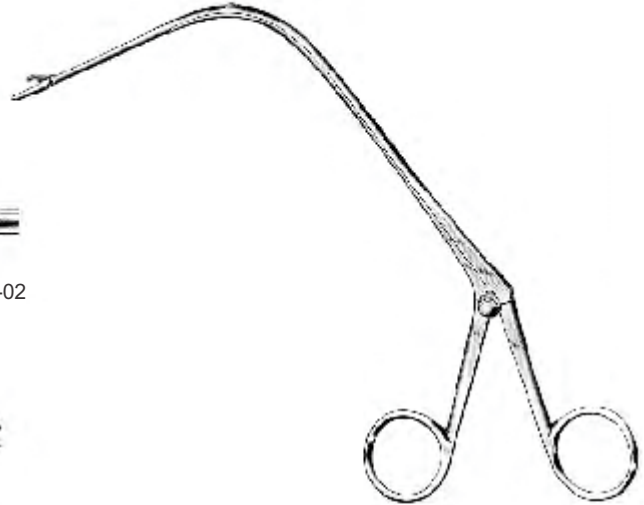

JURASZ
 23.0cm

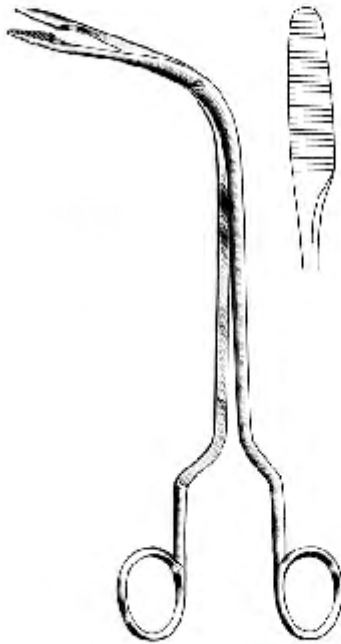

FRAENKEL
 FM- 14-4047-19
 19.0cm



JACKSON
 22.0cm



FM- 14-4048-22



FM- 14-4048-22



REICHERT
 FM- 14-4049-24
 24.0cm

EN	Otology
DE	Otologie
ES	Otología
FR	Otologie
IT	Otologia

Page 197 to 209



EN	Ear Speculas
DE	Ohrspekula
ES	Espéculos auriculares
FR	Spéculums d'oreille
IT	Ear Speculas



TROELTSCH

- FM- 15-4201-00 set/3
- FM- 15-4201-01 6mm Ø, Fig. 1
- FM- 15-4201-02 7mm Ø, Fig. 2
- FM- 15-4201-03 8mm Ø, Fig. 3



HARTMANN (for children)

- FM- 15-4202-00 set/3
- FM- 15-4202-00 3mm Ø, Fig.0
- FM- 15-4202-01 4mm Ø, Fig.1
- FM- 15-4202-02 5mm Ø, Fig.2



HARTMANN (for adults)

- FM- 15-4203-00 set/4
- FM- 15-4203-01 4.0mm Ø, Fig. 1
- FM- 15-4203-02 5.0mm Ø, Fig. 2
- FM- 15-4203-03 6.0mm Ø, Fig. 3
- FM- 15-4203-04 7.5mm Ø, Fig. 4



TOYNBEE (for adults)

- FM- 15-4204-00 set/4
- FM- 15-4204-01 4mm Ø, Fig. 1
- FM- 15-4204-02 5mm Ø, Fig. 2
- FM- 15-4204-03 6mm Ø, Fig. 3
- FM- 15-4204-04 7mm Ø, Fig. 4



GRUBER (for adults)

- FM- 15-4205-00 set/4
- FM- 15-4205-01 4.5mm Ø, Fig. 1
- FM- 15-4205-02 5.5mm Ø, Fig. 2
- FM- 15-4205-03 6.5mm Ø, Fig. 3
- FM- 15-4205-04 7.5mm Ø, Fig. 4



GRUBER

- FM- 15-4206-00 set/4
- FM- 15-4206-01 4.5mm Ø, Fig. 1
- FM- 15-4206-02 5.5mm Ø, Fig. 2
- FM- 15-4206-03 6.5mm Ø, Fig. 3
- FM- 15-4206-04 7.5mm Ø, Fig. 4



GRUBER

- FM- 15-4207-00 set/4
- FM- 15-4207-01 4.5mm Ø, Fig. 1
- FM- 15-4207-02 5.5mm Ø, Fig. 2
- FM- 15-4207-03 6.5mm Ø, Fig. 3
- FM- 15-4207-04 7.5mm Ø, Fig. 4

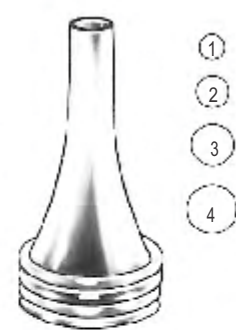

POLITZER

- FM- 15-4208-00 set/4
- FM- 15-4208-01 3.0mm Ø, Fig. 1
- FM- 15-4208-02 4.5mm Ø, Fig. 2
- FM- 15-4208-03 5.5mm Ø, Fig. 3
- FM- 15-4208-04 6.5mm Ø, Fig. 4

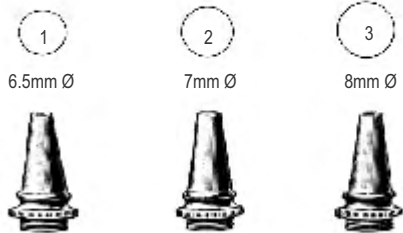

FM- 15-4215-01 FM- 15-4215-02 FM- 15-4215-03



FM- 15-4216-01 FM- 15-4216-02 FM- 15-4216-03 FM- 15-4216-04



SIEGLE

- FM- 15-4215-00 set
- FM- 15-4215-04 otoscope
- FM- 15-4215-05 rubber bulb
- FM- 15-4215-01,02,03 speculas



FM- 15-4216-00 Compl.



BRUENINGS

- FM- 15-4216-05 set of 4 speculas
- FM- 15-4216-06 rubber bulb
- FM- 15-4216-07 wooden case only
- FM- 15-4216-10 otoscope

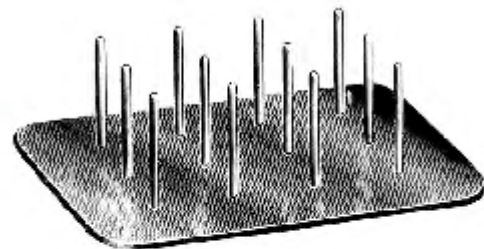

FM- 15-4217-01
support for specula

EN	Ear Speculas
DE	Ohrspekula
ES	Espéculos auriculares
FR	Spéculums d'oreille
IT	Ear Speculas



FM- 15-4218-01 FM- 15-4218-02 FM- 15-4218-03 FM- 15-4218-04
cannula



FM- 15-4218-05
valve connection



FM- 15-4218-06
suction end



FM- 15-4218-07
protecting disk



FM- 15-4218-08
exible tube only

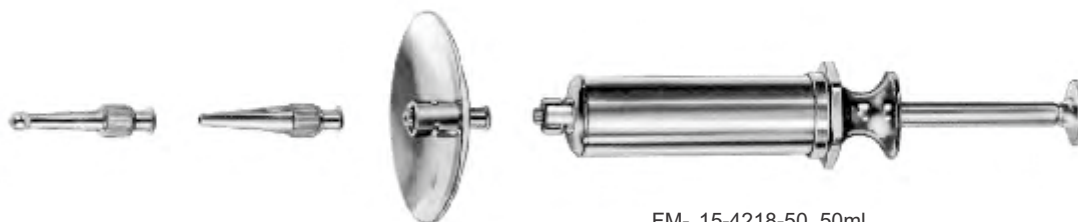

FM- 15-4218-50 50ml
FM- 15-4218-75 75ml
FM- 15-4218-10 100ml
ear syringe. complete. Self- lling



LUER
FM- 15-4219-01 bulb tip FM- 15-4219-04
FM- 15-4219-02 conical tip FM- 15-4219-05
FM- 15-4219-03 shield FM- 15-4219-06

PIMEROY		LUER	
FM- 15-4219-50	50cc	FM- 15-4219-50A	
FM- 15-4219-75	75cc	FM- 15-4219-75A	
FM- 15-4219-10	100cc	FM- 15-4219-10A	
FM- 15-4219-15	150cc	FM- 15-4219-15A	
FM- 15-4219-20	200cc	FM- 15-4219-20A	

Tuning Forks	EN
Stimmgabeln	DE
Diapasones	ES
Fourches d'accord	FR
Diapason	IT

Tuning Forks



Hartmann



Lucae



French Hartmann



Lucae
C 128



Hartmann
C 128



Rydel-Seiffer
FM- 15-4225-00
C 64/C 128

- | | | | |
|------|----------------|----------------|----------------|
| 16 | | | |
| 32 | | | |
| 64 | | | |
| 128 | FM- 15-4220-00 | FM- 15-4221-00 | FM- 15-4222-16 |
| 256 | FM- 15-4220-01 | FM- 15-4221-01 | FM- 15-4222-32 |
| 512 | FM- 15-4220-02 | FM- 15-4221-02 | FM- 15-4222-01 |
| 1024 | FM- 15-4220-03 | FM- 15-4221-03 | FM- 15-4222-02 |
| 2048 | FM- 15-4220-04 | FM- 15-4221-04 | FM- 15-4222-03 |
| 4096 | FM- 15-4220-05 | FM- 15-4221-05 | |

Variable up to h (Engl. B)
FM- 15-4223-00 FM- 15-4224-00

With Clamps = C 64
Without Clamps = C 128

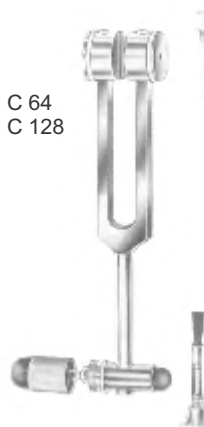

Tuning Fork for neuro-logical examination, with percussion hammer, pin wheel, brush and needle
FM- 15-4226-00



FM- 15-4227-01
C 64



FM- 15-4227-02
C 128



FM- 15-4227-03
C 256



FM- 15-4227-04
C 512
aluminum



FM- 15-4227-05
C 1024
aluminum



FM- 15-4227-06
C 2048
aluminum



FM- 15-4227-07
C 4096
aluminum



TROELTSCH

- FM- 15-4228-01 Fig. 1
- FM- 15-4228-02 Fig. 2
- FM- 15-4228-03 Fig. 3
- FM- 15-4228-04 Fig. 4
- FM- 15-4228-05 Fig. 5

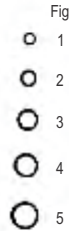

LUCAE

- FM- 15-4229-01 Fig. 1
- FM- 15-4229-02 Fig. 2
- FM- 15-4229-03 Fig. 3
- FM- 15-4229-04 Fig. 4
- FM- 15-4229-05 Fig. 5



WOAKES

- FM- 15-4230-01

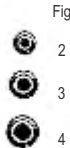

HARTMANN

- FM- 15-4231-02 Fig. 2
- FM- 15-4231-03 Fig. 3
- FM- 15-4231-04 Fig. 4

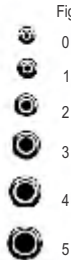

HARTMANN

- FM- 15-4232-00 Fig. 0
- FM- 15-4232-01 Fig. 1
- FM- 15-4232-02 Fig. 2
- FM- 15-4232-03 Fig. 3
- FM- 15-4232-04 Fig. 4
- FM- 15-4232-05 Fig. 5



HARTMANN

- FM- 15-4233-00 Fig. 0
- FM- 15-4233-01 Fig. 1
- FM- 15-4233-02 Fig. 2
- FM- 15-4233-03 Fig. 3
- FM- 15-4233-04 Fig. 4
- FM- 15-4233-05 Fig. 5

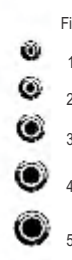

ITARD

- FM- 15-4234-01 Fig. 1
- FM- 15-4234-02 Fig. 2
- FM- 15-4234-03 Fig. 3
- FM- 15-4234-04 Fig. 4
- FM- 15-4234-05 Fig. 5

Ear Polypus Snares and Ear Dressing Forceps **EN**
 Polypenschnürer, Ohrpinzetten **DE**
 Polipótomos, Pinzas auriculares **ES**
 Colliers d'oreille Polypus et pinces à pansements auriculaires **FR**
 Pinze per polipi e per orecchie **IT**

15



OTOLOGY



Krause
 FM- 15-4235-16
 16 cm/6 1/4"



Krause-Voss
 FM- 15-4236-16
 16 cm/6 1/4"



Lange-Wilde
 FM- 15-4237-16
 16 cm/6 1/4"



Package of 1 dozen each

mm Ø
 FM- 15-4238-02 0.2
 FM- 15-4238-03 0.3



FM- 15-4238-03 0.3mm Ø
 FM- 15-4238-04 0.4mm Ø



TROELTSCH (WILDE)
 FM- 15-4239-13 13.0cm

Ear Dressing Forceps



Troeltsch (Wilde)

FM- 15-4240-11
 FM- 15-4240-12
 FM- 15-4240-14
 FM- 15-4240-15

Troeltsch
 1 x 2 teeth

FM- 15-4243-11
 FM- 15-4243-12



Lucae

FM- 15-4244-14



Lucae
 1 x 2 teeth

FM- 15-4245-14



Jansen

FM- 15-4246-16
 FM- 15-4246-18
 FM- 15-4246-20

Cm	In
11.0	4 1/4"
12.0	4 3/4"
14.0	5 1/2"
15.0	6"
16.0	6 1/4"
18.0	7"
20.0	8"



Okonogto
 FM- 15-4247-16
 16 cm/6¼"



Littauer
 FM- 15-4248-12
 12 cm/4¾"



Hartmann
 FM- 15-4249-12
 12 cm/4¾"

Fine Pattern



Hartmann
 FM- 15-4250-14
 14 cm/5½"

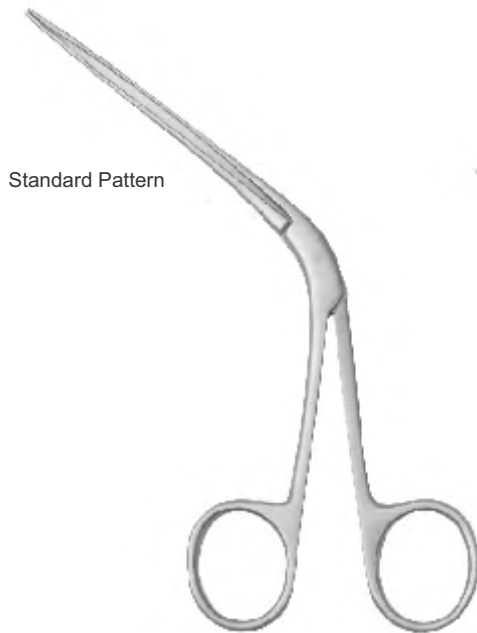

Standard Pattern

Tilley Aural Forcep
 FM- 15-4251-14 14cm/5 ½"
 FM- 15-4251-16 16cm/6 ¼"
 FM- 15-4251-18 18cm/7"



Buck
 FM- 15-4252-09
 9 cm/3½"



Quire
 FM- 15-4253-08
 8 cm/3¼"

Ear Polypus Forceps EN

Ohr-Polypenzangen DE

Pinzas para pólipos auriculares ES

Pince à polypes auriculaires FR

Pinza per polipi auricolari IT

15



FAIZAN & MUSA
SPECIAL INSTRUMENTS

OTOLOGY



Hartmann-Noyes
FM- 15-4254-09
8.5 cm/3¹/₄"

1 : 2



Hartmann-Noyes
FM- 15-4255-09
8.5 cm/3¹/₄"



Hartmann
FM- 15-4256-09 8.5 cm/3 ¹/₄"
FM- 15-4256-14 14 cm/5 ¹/₂"
FM- 15-4256-16 16 cm/6 ¹/₂"

1 : 2



Hartmann
FM- 15-4257-09 8.5 cm/3 ¹/₄"
FM- 15-4257-14 14.0 cm/5 ¹/₂"



Hartmann
FM- 15-4258-20 8.5 cm/3 ¹/₄"
FM- 15-4258-25 8.5 cm/3 ¹/₄"
FM- 15-4258-30 8.5 cm/3 ¹/₄"



Hartmann-Citelli
FM- 15-4259-02 2 mm 8.5 cm/3 ¹/₄"
FM- 15-4259-03 3 mm 8.5 cm/3 ¹/₄"



Strumpel
FM- 15-4260-09
8.5 cm/3¹/₄"



Hartamm-Weingartner
FM- 15-4261-09
8.5 cm/3¹/₄"



HARTMANN
FM- 15-4261-10 8.5cm



Hartamm
FM- 15-4262-09
8.5 cm/3¹/₄"



Hartamm-Wullstein
FM- 15-4263-06 8.5 cm/3 ¹/₄" 08 x 6 mm
FM- 15-4263-08 8.5 cm/3 ¹/₄" 1.8 x 8 mm

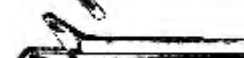

HARTMANN
FM- 15-4263-09 8.5cm



Hartamm-Hoffmann
FM- 15-4264-01 1 mm 8.5 cm/3 ¹/₄"
FM- 15-4264-02 2 mm 8.5 cm/3 ¹/₄"

EN Micro Ear Polypus Forceps
 DE Ohr-Polypenzangen
 ES Pinzas para pólipos auriculares
 FR Micro oreille Polypus Forceps
 IT Pinza per polipi auricolari



MINI McGEE ALLIGATOR

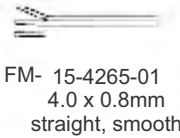

FM- 15-4265-01
 4.0 x 0.8mm
 straight, smooth

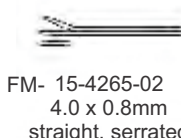

FM- 15-4265-02
 4.0 x 0.8mm
 straight, serrated

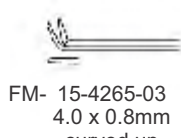

FM- 15-4265-03
 4.0 x 0.8mm
 curved up

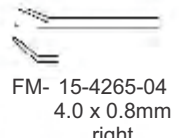

FM- 15-4265-04
 4.0 x 0.8mm
 right

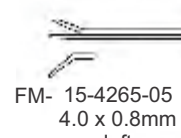

FM- 15-4265-05
 4.0 x 0.8mm
 left

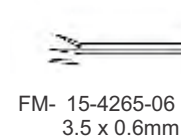

FM- 15-4265-06
 3.5 x 0.6mm
 straight, smooth

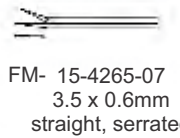

FM- 15-4265-07
 3.5 x 0.6mm
 straight, serrated

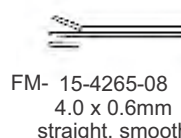

FM- 15-4265-08
 4.0 x 0.6mm
 straight, smooth

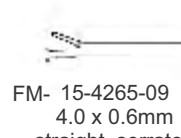

FM- 15-4265-09
 4.0 x 0.6mm
 straight, serrated

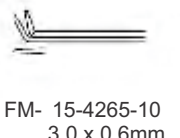

FM- 15-4265-10
 3.0 x 0.6mm
 curved up, serrated

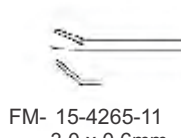

FM- 15-4265-11
 3.0 x 0.6mm
 right, serrated

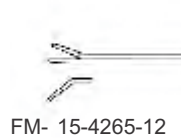

FM- 15-4265-12
 3.0 x 0.6mm
 left, serrated



0.6mm



FM- 15-4266-01
 3.5 x 0.5mm
 straight



FM- 15-4266-02
 3.5 x 0.5mm
 curved up



FM- 15-4266-03
 3.5 x 0.5mm
 right

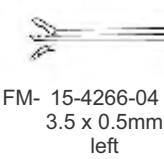

FM- 15-4266-04
 3.5 x 0.5mm
 left



1.0mm



FM- 15-4267-01
 4.0 x 0.9mm
 straight

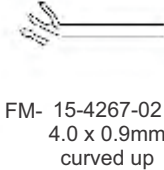

FM- 15-4267-02
 4.0 x 0.9mm
 curved up



FM- 15-4267-03
 4.0 x 0.9mm
 right

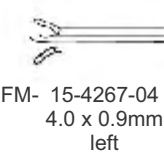

FM- 15-4267-04
 4.0 x 0.9mm
 left

Micro Ear and Wire Closure Forceps EN

Micro Ear and Wire Closure Zange DE

Micro del oído y pinzas de alambre de cierre ES

Micro oreille et pince de fermeture de li FR

Pinza per chiusura micro orecchie e li IT

15



Henckel
crocodile, scoop blades
FM- 15-4280-02

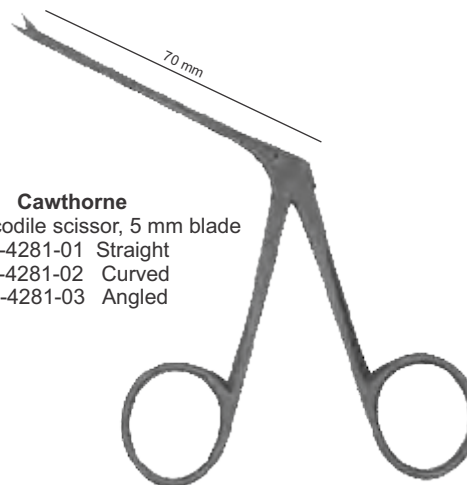

Cawthorne
micro crocodile scissor, 5 mm blade
FM- 15-4281-01 Straight
FM- 15-4281-02 Curved
FM- 15-4281-03 Angled

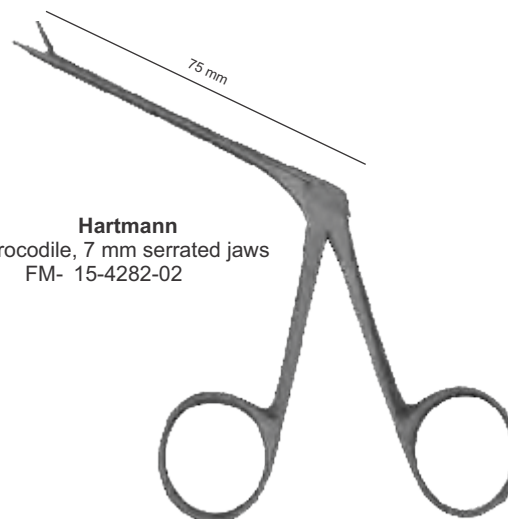

Hartmann
crocodile, 7 mm serrated jaws
FM- 15-4282-02

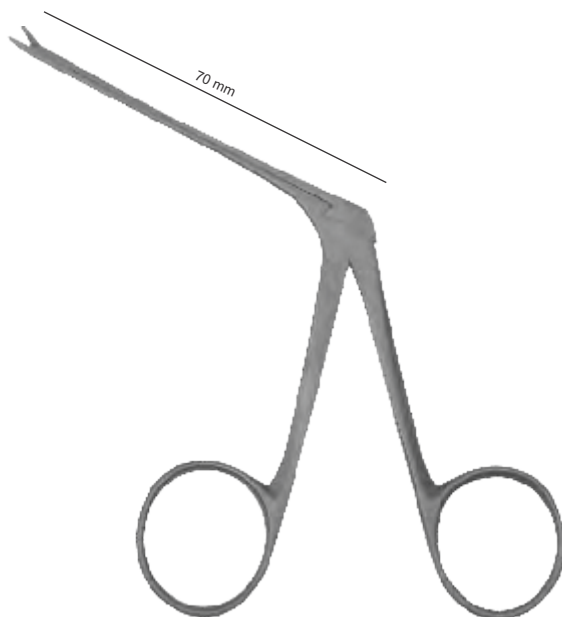

Hartmann
micro crocodile, 3 mm serrated jaws
FM- 15-4283-02

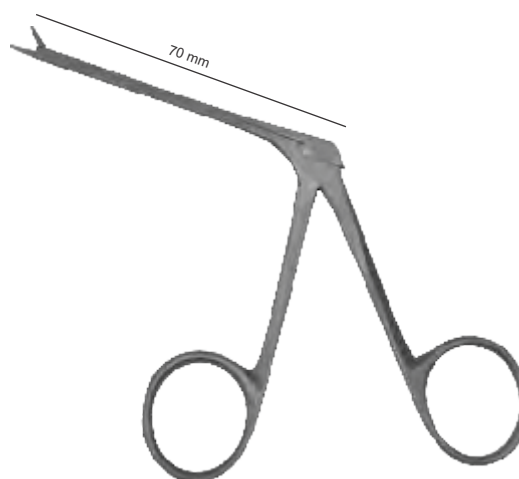

Hough
medium micro crocodile
5 mm serrated jaws
FM- 15-4284-01 Straight
FM- 15-4284-02 Angled

Needles And Hooks

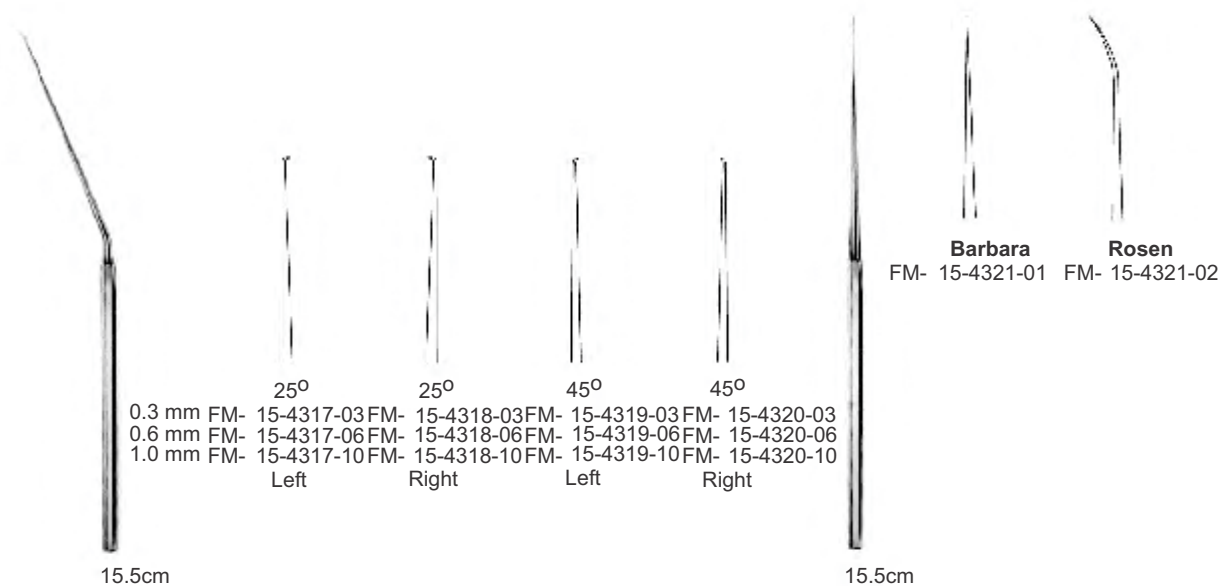
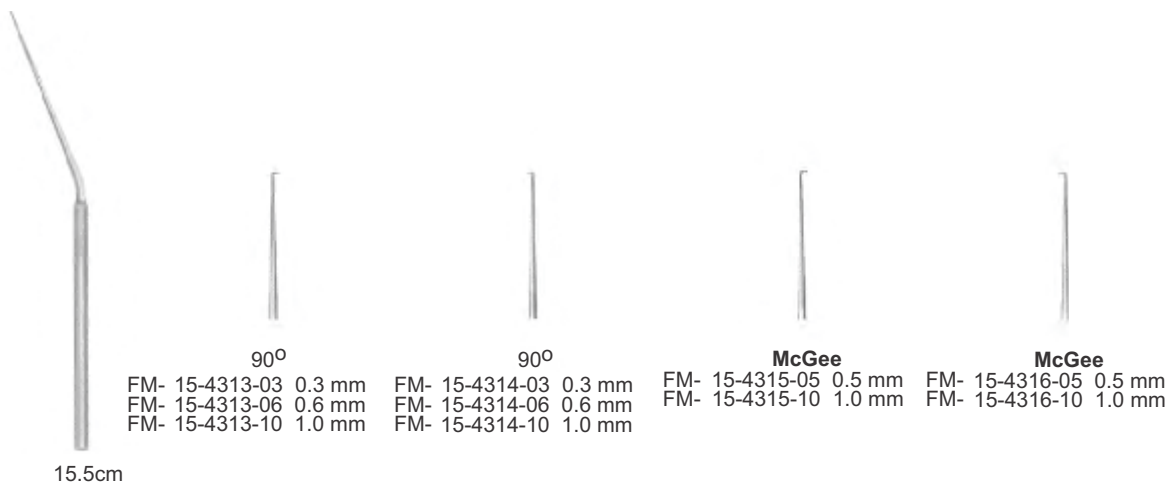

Dissectors, Measuring Road, Elevators, Curettes and Mobilizer

OTOLOGY

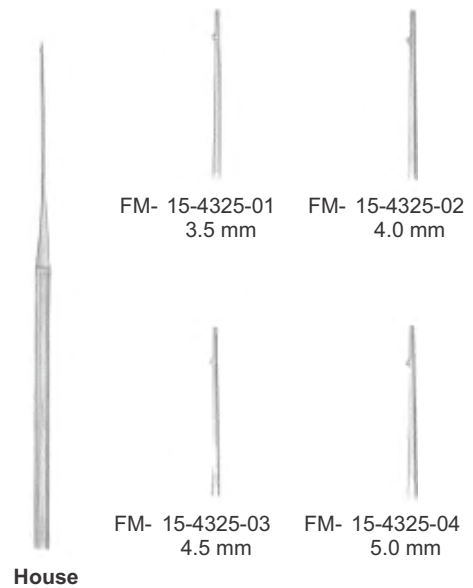
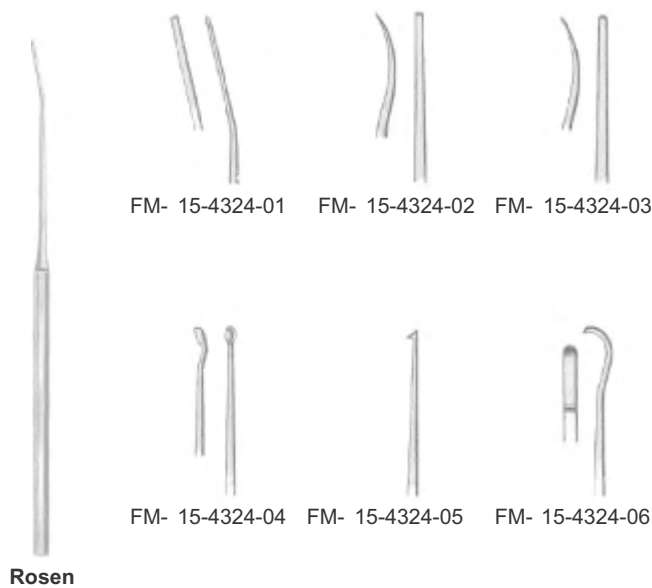



Citelli
 Width of Bite FM- 15-4337-20 2.0 mm
 FM- 15-4337-30 3.0 mm







Citelli-Beyer
 Width of Bite FM- 15-4338-15 1.5 mm
 FM- 15-4338-20 2.0 mm



Width of Bite



Brunings
 FM- 15-4339-40
 FM- 15-4339-60

-  FM- 15-4340-30 3.0 mm
-  FM- 15-4340-40 4.0 mm
-  FM- 15-4340-50 5.0 mm
-  FM- 15-4340-60 6.0 mm



Kerrison
 20 cm/8"



FAIZAN & MUSA
SPECIAL INSTRUMENTS

EN	Rhinology
DE	Rhinologie
ES	Rinología
FR	Rhinologie
IT	Rhinology

Page 210 to 223



EN	Nasal Speculas
DE	Nasenspekula
ES	Espéculos nasales
FR	Spéculums nasaux
IT	Specula nasale

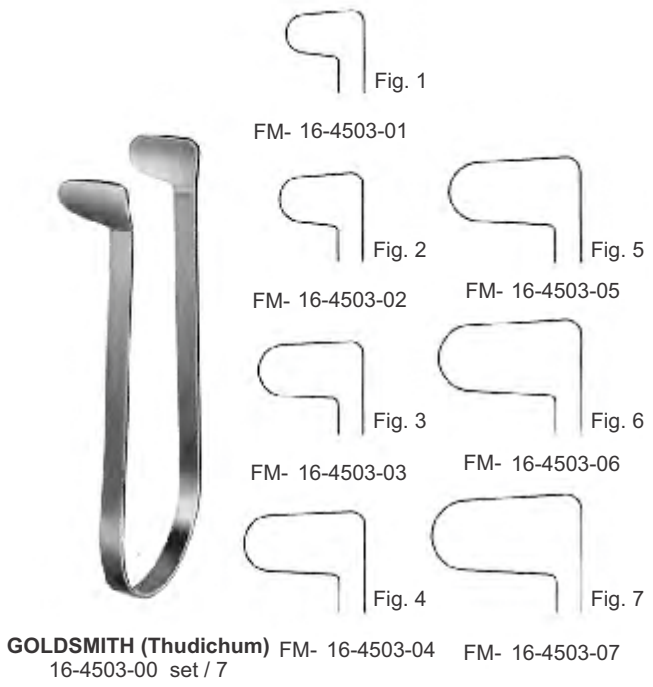
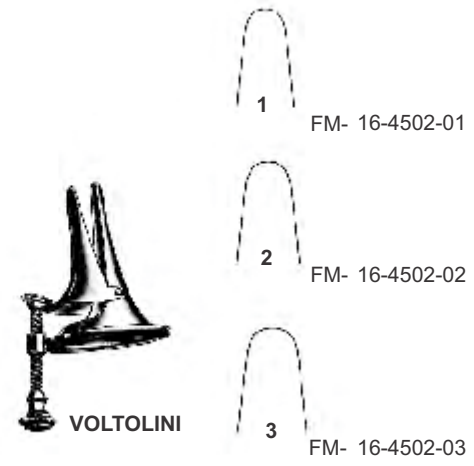

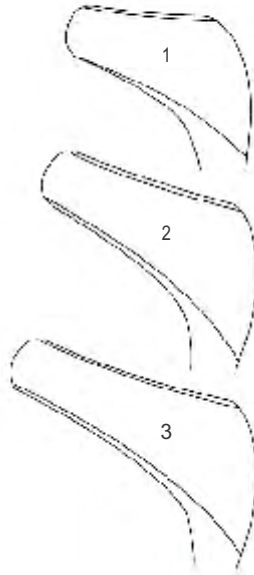

HARTMANN-HALLE
15.0cm
FM- 16-4505-01 Fig. 1
FM- 16-4505-02 Fig. 2
FM- 16-4505-03 Fig. 3

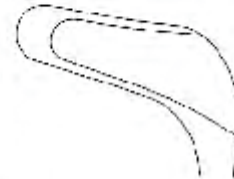

SCHWARZ
FM- 16-4506-14
14.0cm



VIENNA
14.5cm
FM- 16-4507-01 (infant)
FM- 16-4507-02 (child)
FM- 16-4507-03 (adult)
FM- 16-4507-04 (sheet metal)



MOD WIEN
FM- 16-4508-14
14.5cm

EN	Nasal Speculas
DE	Nasenspekula
ES	Espéculos nasales
FR	Spéculums nasaux
IT	Specula nasale



FM- 16-4509-13
13.0cm



FM- 16-4510-13
13.0cm



TIECK-HALLE
13.5cm
FM- 16-4511-01
FM- 16-4511-02



TIECK-HALLE
FM- 16-4512-13
13.5cm



KILLIAN
13.0cm
FM- 16-4513-35
FM- 16-4513-50
FM- 16-4513-75
FM- 16-4513-90

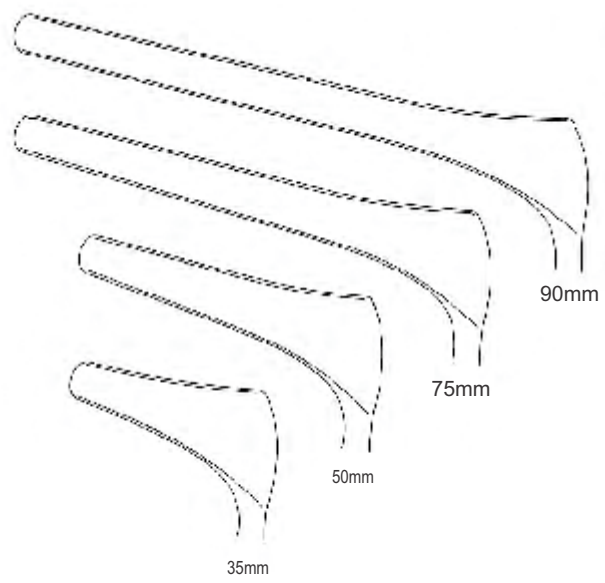

KILLIAN (with side screw)
13.0cm
FM- 16-4514-35
FM- 16-4514-50
FM- 16-4514-75
FM- 16-4514-90

Nasal Speculas **EN**
 Nasenspekula **DE**
 Espéculos nasales **ES**
 Spéculums nasaux **FR**
 Pinze per dissezione **IT**

16

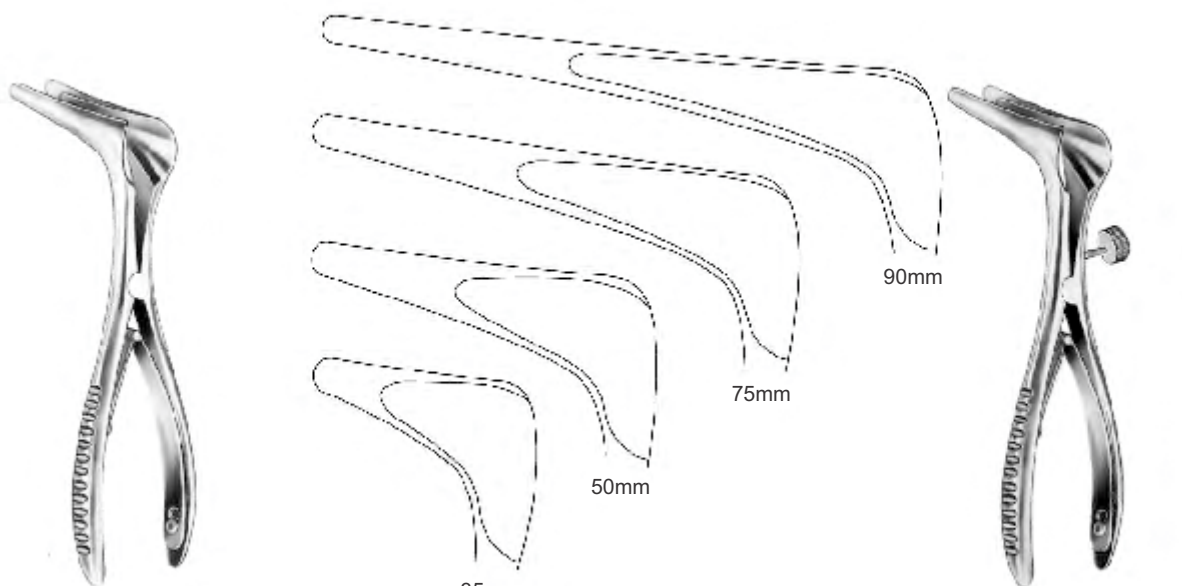

COTTLE
 15.0cm
 FM- 16-4515-35
 FM- 16-4515-50
 FM- 16-4515-75
 FM- 16-4515-90

COTTLE (with side screw)
 15.0cm
 FM- 16-4516-35
 FM- 16-4516-50
 FM- 16-4516-75
 FM- 16-4516-90

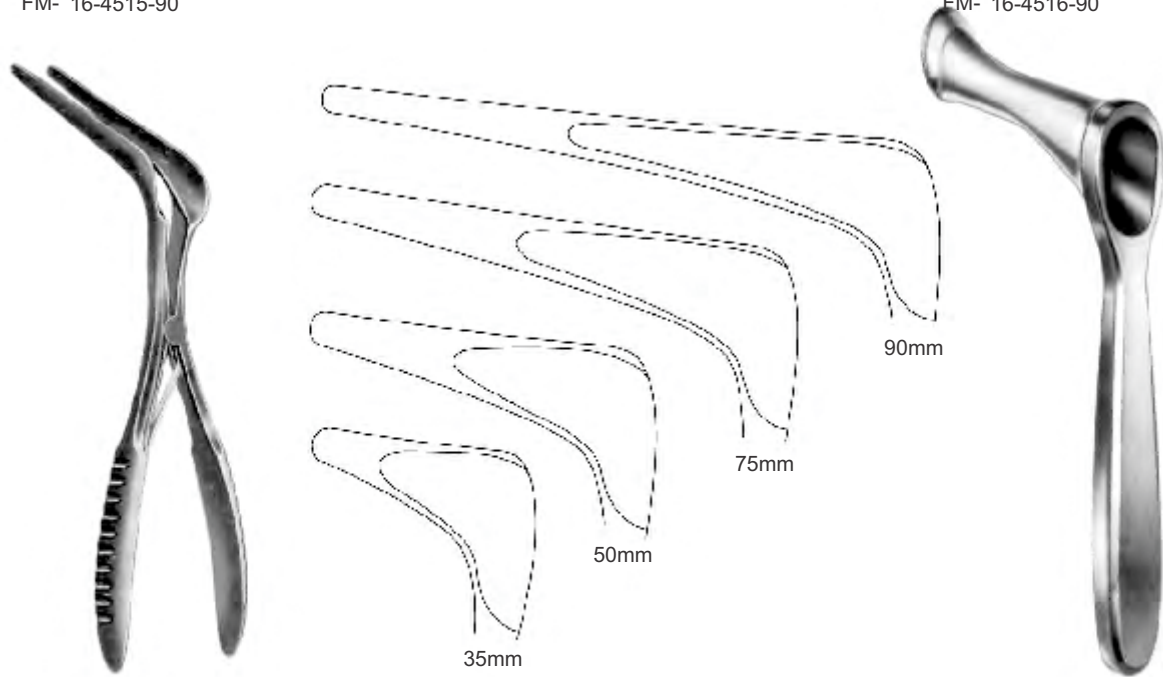

COTTLE
 (dull black chromium plated)
 14.0cm
 FM- 16-4517-35
 FM- 16-4517-50
 FM- 16-4517-75
 FM- 16-4517-90

YANKAUER
 FM- 16-4518-19
 19.0cm

EN	Nasal Snares
DE	Polypenschnurer
ES	Polipotomos
FR	Spéculums nasaux
IT	Specula nasale



FM- 16-4519-03 0.3mm Ø
FM- 16-4519-04 0.4mm Ø



FM- 16-4520-02 0.2mm Ø
FM- 16-4520-03 0.3mm Ø



KRAUSE
FM- 16-4521-26
26.0cm

KRAUSE-VOSS
FM- 16-4522-26
26.0cm

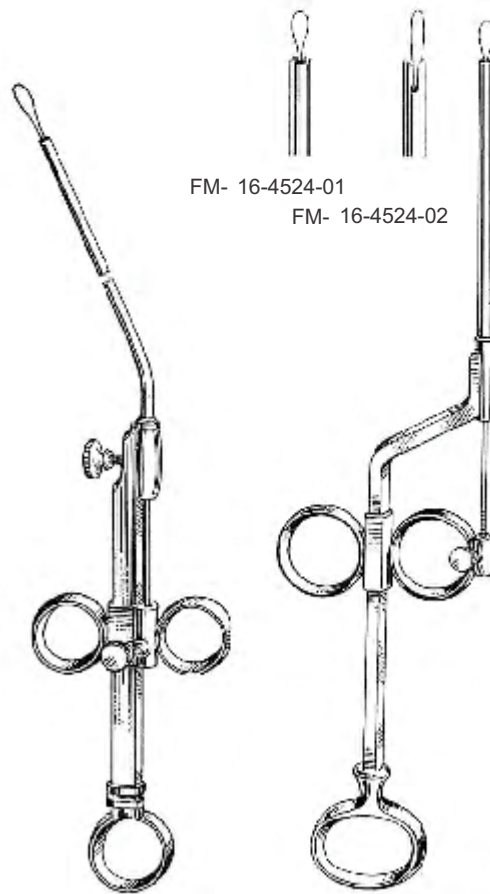

FM- 16-4524-01
FM- 16-4524-02

KRAUSE
FM- 16-4523-00

GLEGG

Nasal Polypus and Septum Compression Forceps **EN**
 Polypenzangen, Septumzange **DE**
 Pinzas para polipos, pinzas para el tabique nasal **ES**
 Polypes nasaux et pinces de compression à septum **FR**
 Polipi nasali e pinze per la compressione del setto **IT**

16



RHINOLOGY



KILLIAN
 FM- 16-4525-17
 17.0cm



LITTAUER
 FM- 16-4526-18
 18.0cm



HARTMANN
 FM- 16-4527-20
 20.0cm



QUIRE
 FM- 16-4528-12
 12.0cm

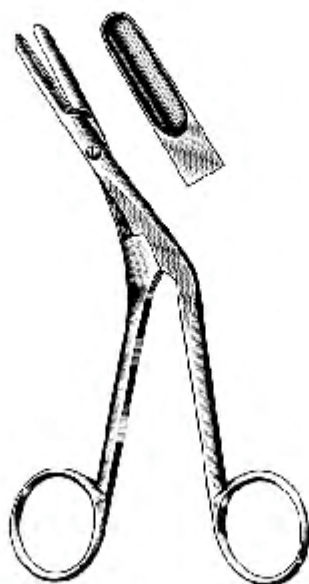

GRAIG
 FM- 16-4529-18
 18.0cm



FM- 16-4530-01 FM- 16-4530-02

18.0cm

EN Nasal Polypus and Septum Compression Forceps
DE Polypenzangen, Septumzange
ES Pinzas para polipos, pinzas para el tabique nasal
FR Polypes nasaux et pinces de compression à septum
IT Polipi nasali e pinze per la compressione del setto



RHINOLOGY



KNIGHT
 FM- 16-4531-18
 18.0cm

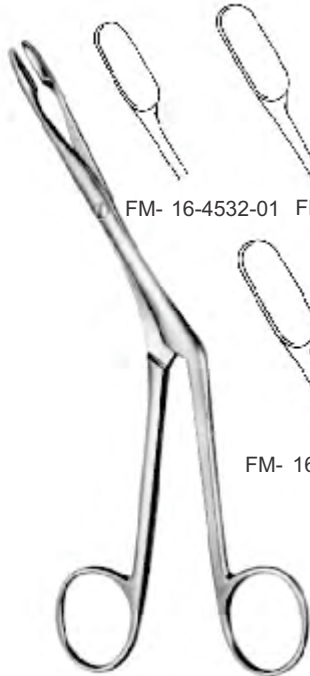

HEYMANN
 18.0cm

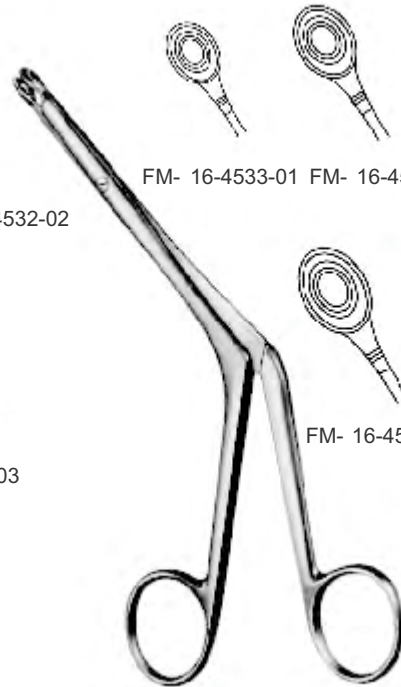

BRUENINGS
 19.0cm

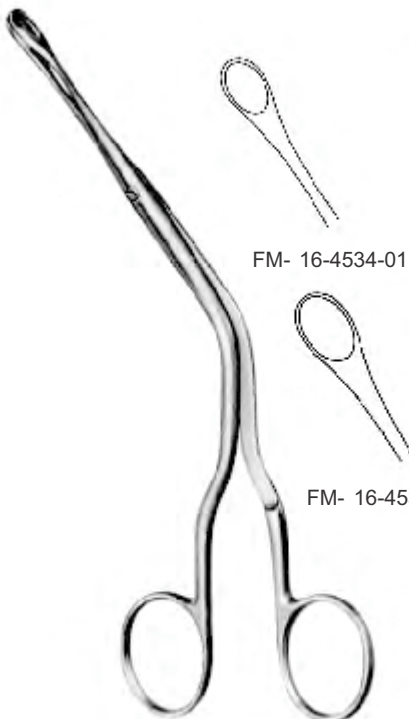

LUC
 20.0cm

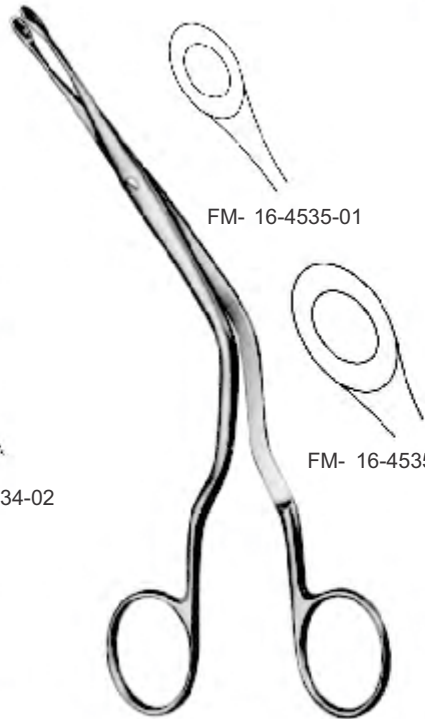

LUC
 20.0cm

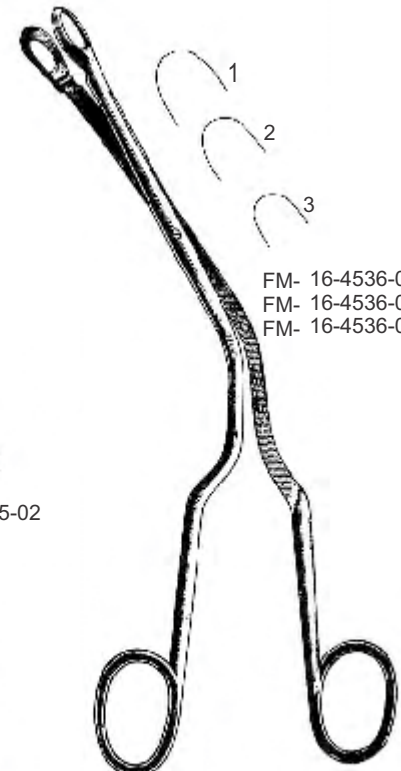

LUC
 20.0cm

FM- 16-4532-01 FM- 16-4532-02

FM- 16-4532-03

FM- 16-4533-01 FM- 16-4533-02

FM- 16-4533-03 FM- 16-4533-04

FM- 16-4534-01

FM- 16-4534-02

FM- 16-4535-01

FM- 16-4535-02

FM- 16-4536-01 Fig. 1
 FM- 16-4536-02 Fig. 2
 FM- 16-4536-03 Fig. 3

Dressing and Tampon Forceps EN

Tamponpinzetten und-zangen DE

Pinzas para compresas y taponamientos ES

Pansement et pinces à tampons FR

Forcipe per medicazioni e tamponi IT

16



FAIZAN & MUSA
SPECIAL INSTRUMENTS

RHINOLOGY

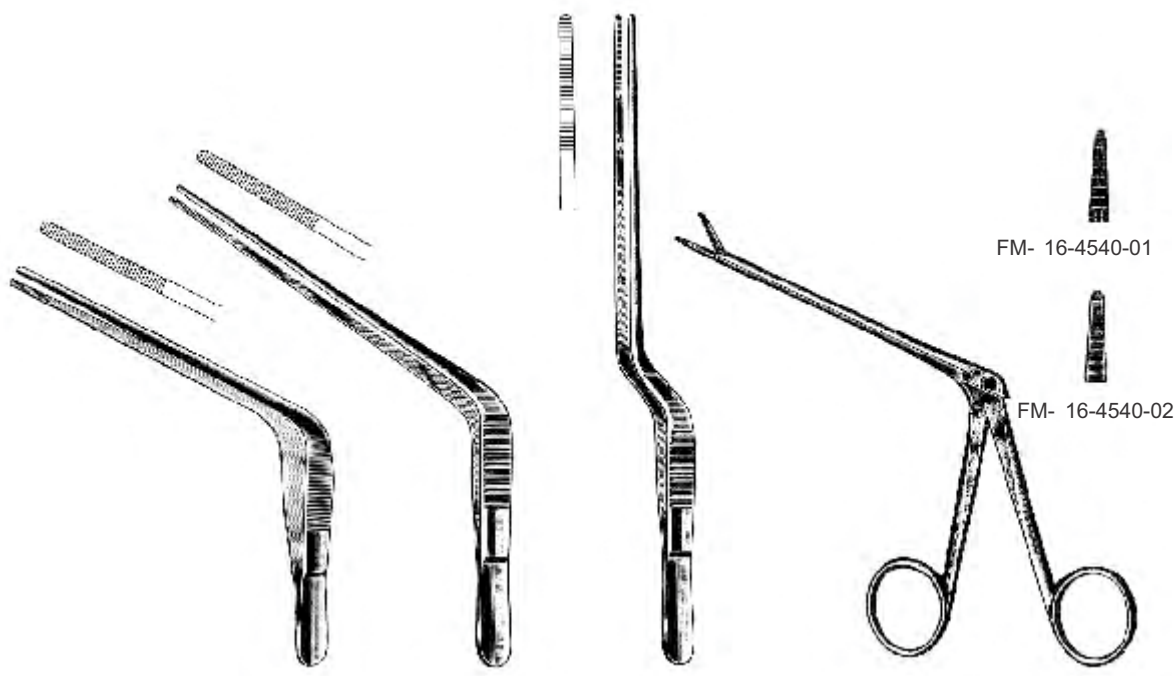

TROELTSCH
FM- 16-4537-15
15.0cm

TROELTSCH
FM- 16-4538-18
18.0cm

GRUENWALD (JANSEN)
FM- 16-4539-20
20.0cm

NOYES
14.5cm

FM- 16-4540-01

FM- 16-4540-02

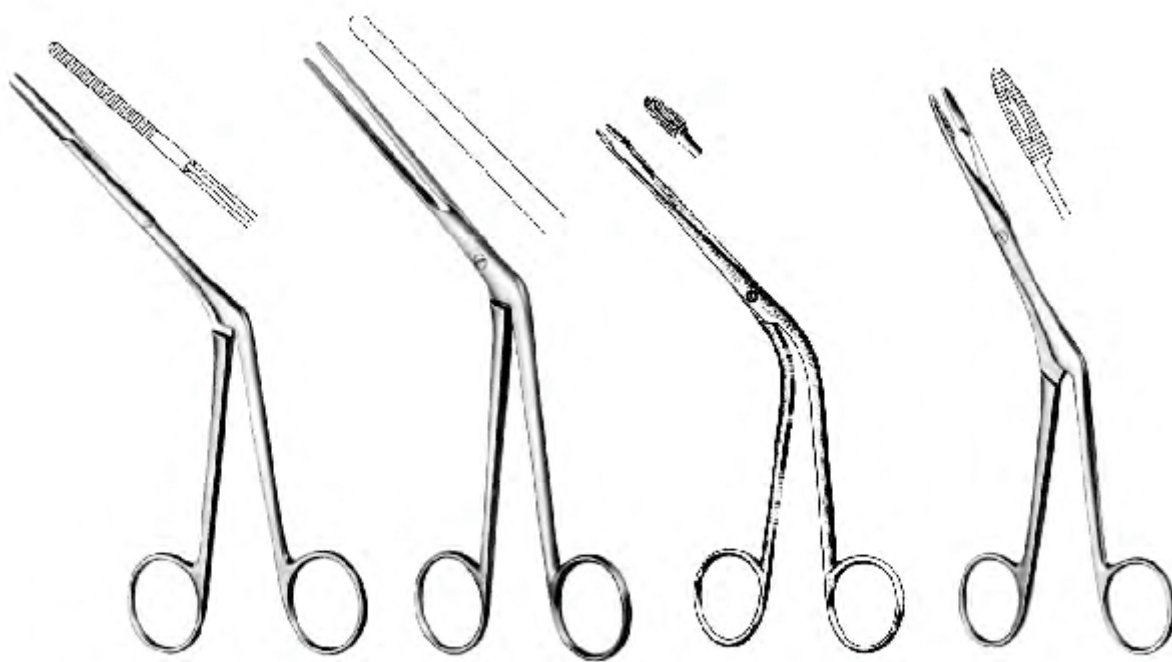

WESTMACOTT
FM- 16-4541-20
20.0cm

LUBET-BARBON
FM- 16-4542-20
20.0cm

HARTMANN
FM- 16-4543-16
16.0cm

HEYMANN-KNIGHT
FM- 16-4544-18
18.0cm

EN	Nasal Cutting Forceps
DE	Scharfe Nasenzangen
ES	Pinzas cortantes cara la nariz
FR	Forceps de coupe nasale
IT	Pinza da taglio nasale

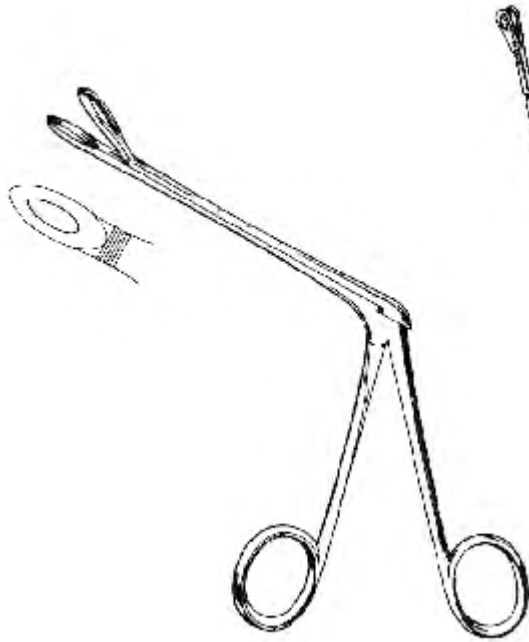

HENCKEL
FM- 16-4545-20
20.0cm

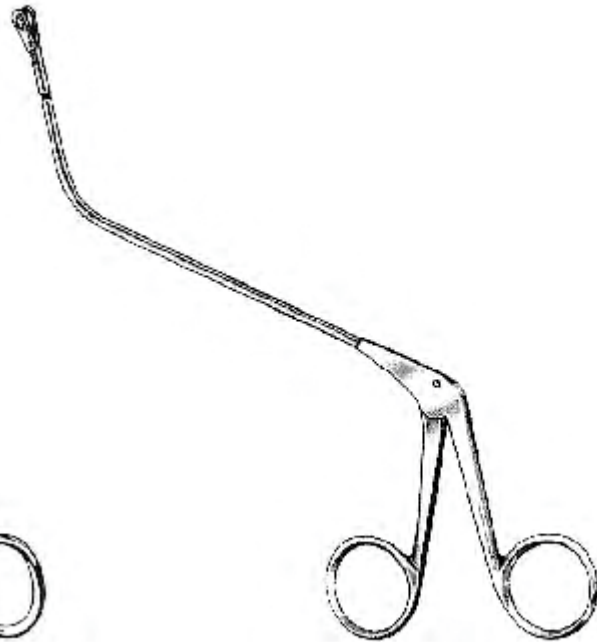

JATHO
FM- 16-4546-15

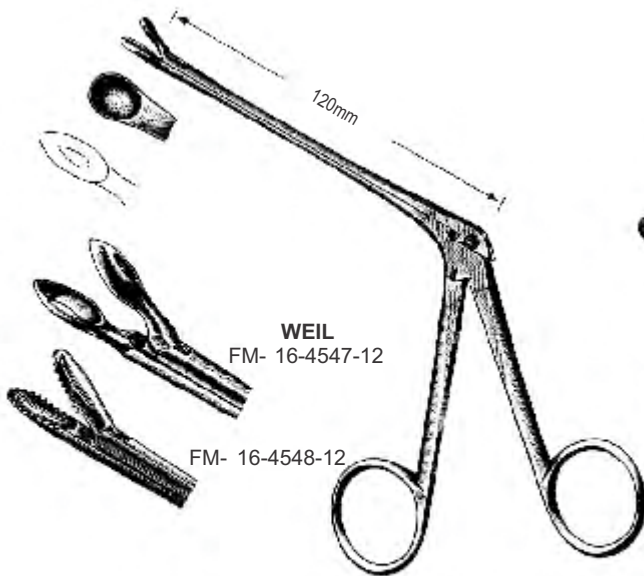

WATSON-WILLIAMS
FM- 16-4548-19
19.0cm

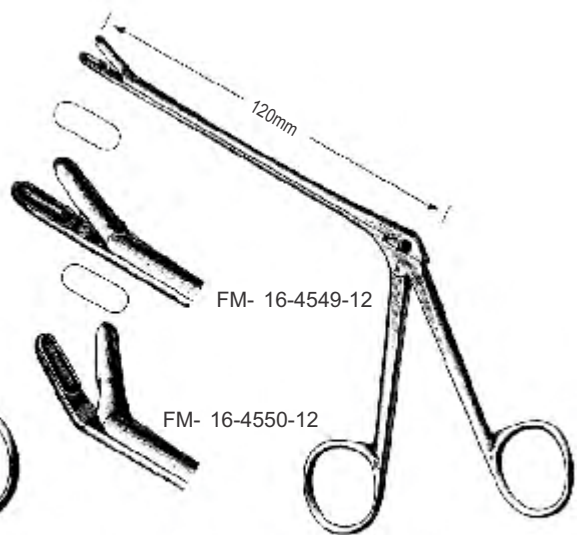

TAKAHASHI
19.0cm

WEIL
FM- 16-4547-12

FM- 16-4548-12

FM- 16-4549-12

FM- 16-4550-12

Nasal Cutting Forceps **EN**

Scharfe Nasenzangen **DE**

Pinzas cortantes cara la nariz **ES**

Forceps de coupe nasale **FR**

Pinza da taglio nasale **IT**

16



FAIZAN & MUSA
SPECIAL INSTRUMENTS

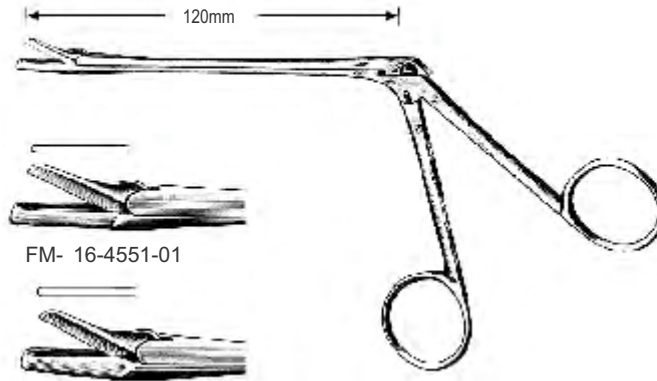

STRUYCKEN
19.0cm

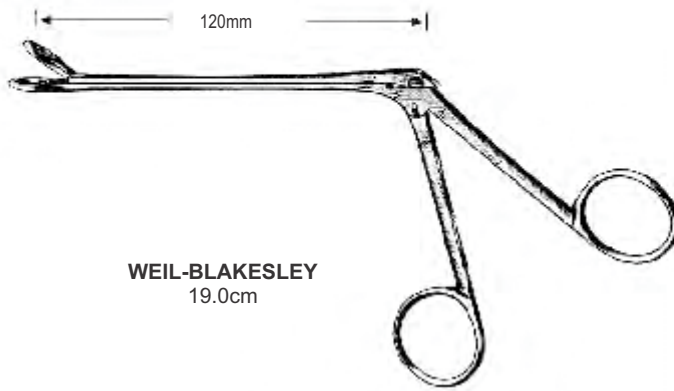

WEIL-BLAKESLEY
19.0cm



without neck FM- 16-4552-01 FM- 16-4552-02 FM- 16-4552-03 FM- 16-4552-04 FM- 16-4552-05



with neck FM- 16-4553-01 FM- 16-4553-02 FM- 16-4553-03 FM- 16-4553-04 FM- 16-4553-05

EN	Nasal Cutting Forceps
DE	Scharfe Nasenzangen
ES	Pinzas cortantes cara la nariz
FR	Forceps de coupe nasale
IT	Pinza da taglio nasale

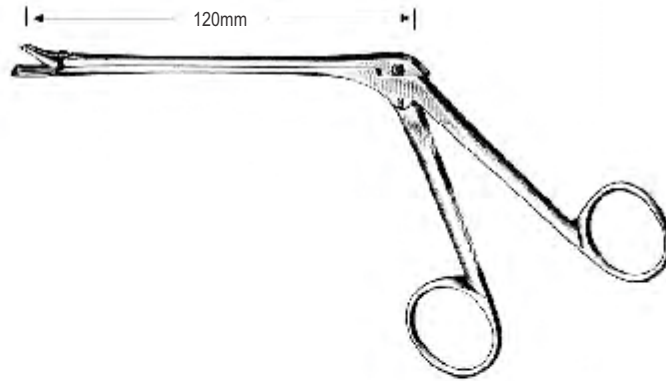

HAJEK
19.0cm

FM- 16-4554-12



SCHMEDEN
19.0cm

FM- 16-4555-12



HARTMANN
19.0cm

FM- 16-4556-01 5mm FM- 16-4556-02 7mm
FM- 16-4556-03 9mm FM- 16-4556-04 11mm



FM- 16-4557-01
2.2mm

FM- 16-4557-02
2.6mm

FM- 16-4557-03
3mm

FM- 16-4557-04
3.4mm



MYLES
19.0 cm

FM- 16-4558-01 FM- 16-4558-02

FM- 16-4558-03

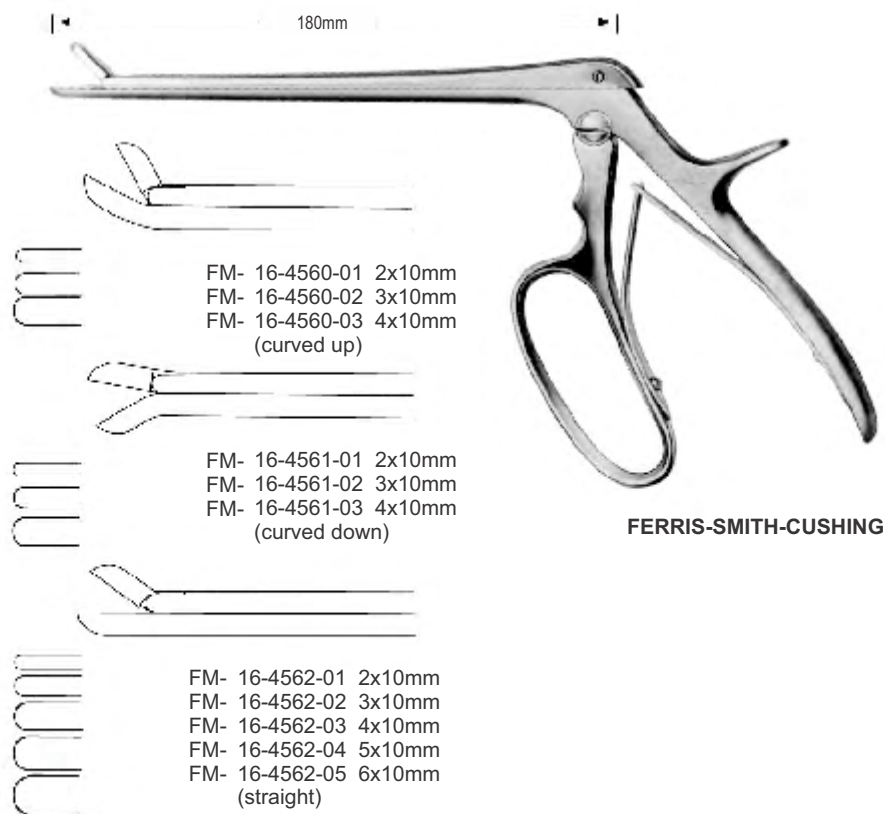
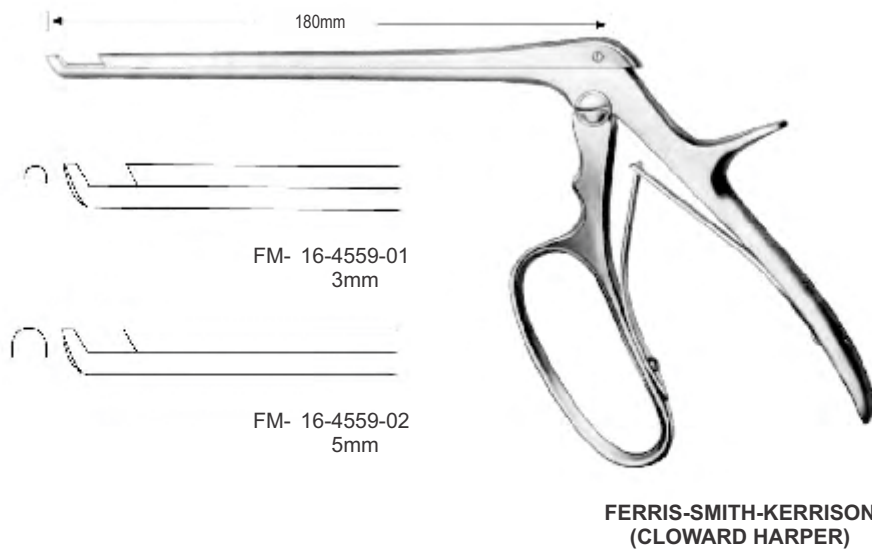

EN	Osteotomes, Gouges, Chisels
DE	Osteotome, Hohlmeißel, Meißel
ES	Osteótomos, gubias, cinceles
FR	Ostéotomes, gouges, ciseaux
IT	Osteotomi, sgorbie, scalpelli



COTTLE
FM- 16-4640-18
18.0cm

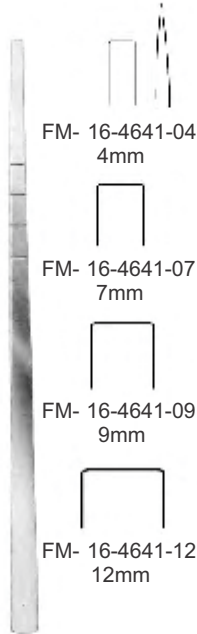

COTTLE
18.0cm



COTTLE
FM- 16-4642-18
18.0cm



COTTLE
FM- 16-4643-18
18.0cm

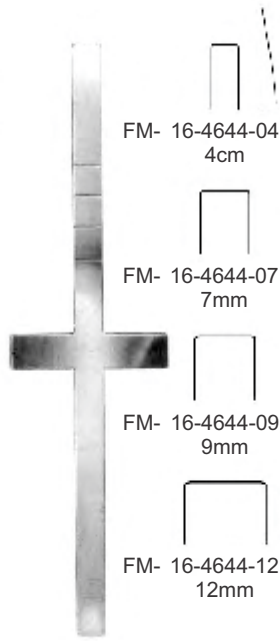

COTTLE
18.0cm

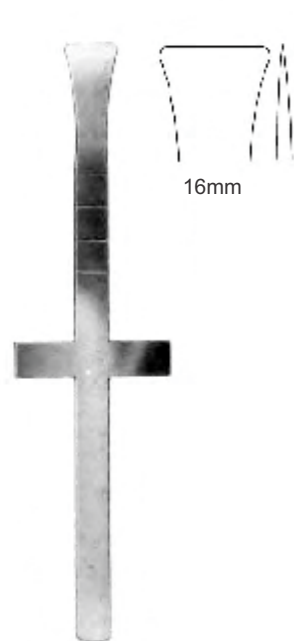

COTTLE
FM- 16-4645-18
18.0cm

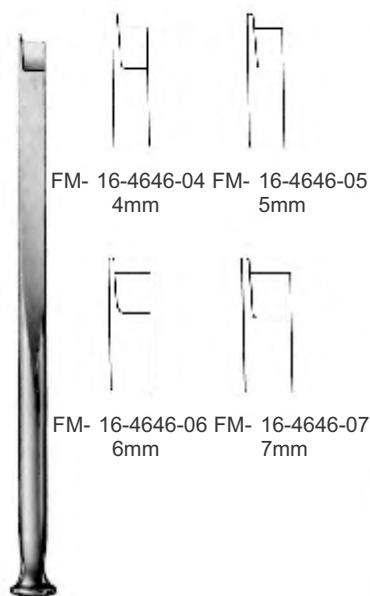

FM- 16-4646-04 FM- 16-4646-05
4mm 5mm

FM- 16-4646-06 FM- 16-4646-07
6mm 7mm

FOMON
17.0cm

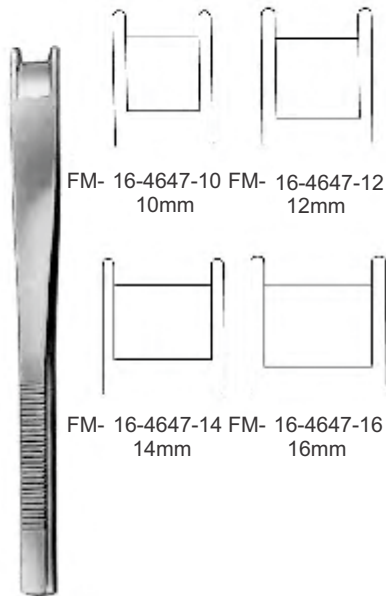

FM- 16-4647-10 FM- 16-4647-12
10mm 12mm

FM- 16-4647-14 FM- 16-4647-16
14mm 16mm

CINELLI
16.0cm

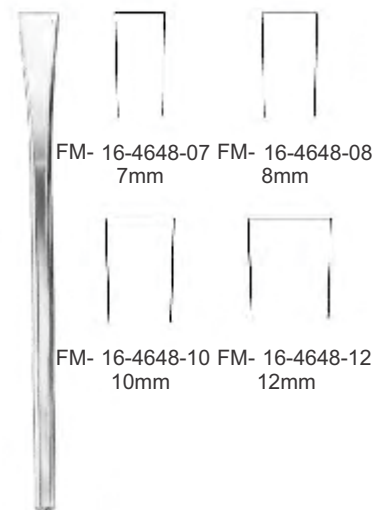

FM- 16-4648-07 FM- 16-4648-08
7mm 8mm

FM- 16-4648-10 FM- 16-4648-12
10mm 12mm

SHEEHAN
17.0cm

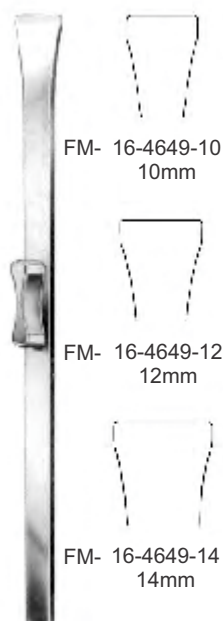

FM- 16-4649-10
10mm

FM- 16-4649-12
12mm

FM- 16-4649-14
14mm

RUBIN
18.0cm

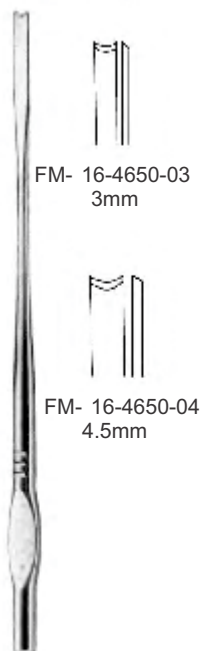

FM- 16-4650-03
3mm

FM- 16-4650-04
4.5mm

WALTER
19.0cm

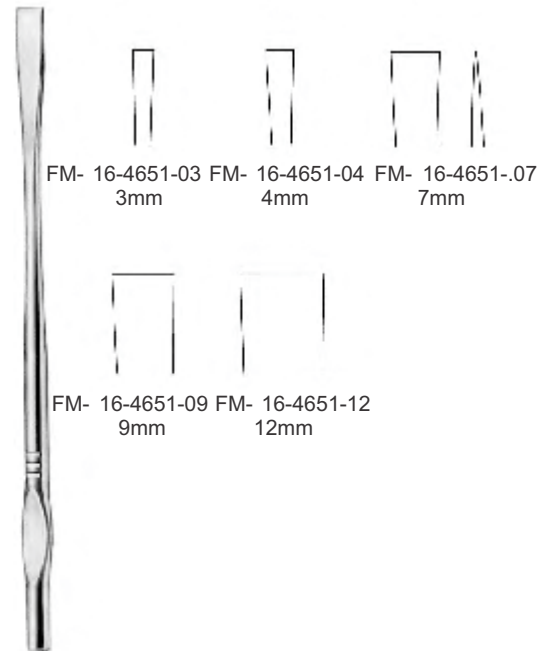

FM- 16-4651-03 FM- 16-4651-04 FM- 16-4651-07
3mm 4mm 7mm

FM- 16-4651-09 FM- 16-4651-12
9mm 12mm

WALTER
19.0cm



FAIZAN & MUSA
SPECIAL INSTRUMENTS

- EN** Oral Instruments
- DE** Mund instrumente
- ES** Cirugía oral
- FR** Instruments oraux
- IT** Strumenti orali

Page 224 to 237



EN	Mouth Gags
DE	Mundsperrer
ES	Abre-bocas
FR	Bouches de la bouche
IT	Bocca Gag

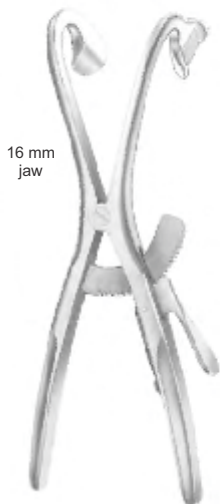

16 mm
jaw

DENHART
FM- 17-4701-12
12 cm/4 3/4"



Silicon jaws
only (pair)
FM- 17-4703-12

DENHART
FM- 17-4702-12
12 cm/4 3/4"



ROSER-KONIG

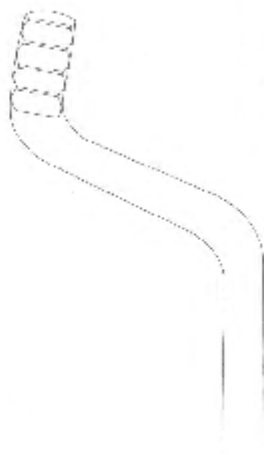

FM- 17-4704-16
16 cm/6 1/4"

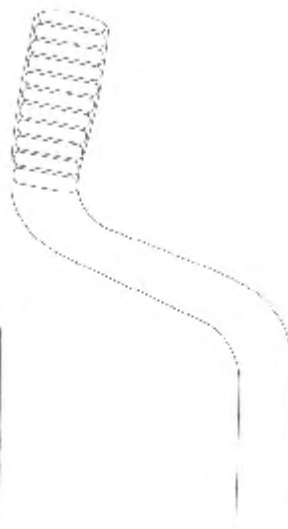

FM- 17-4704-19
19 cm/7 1/2"

Mouth Gags	EN
Mundsperrer	DE
Abre-bocas	ES
Bouches de la bouche	FR
Bocca Gag	IT

17

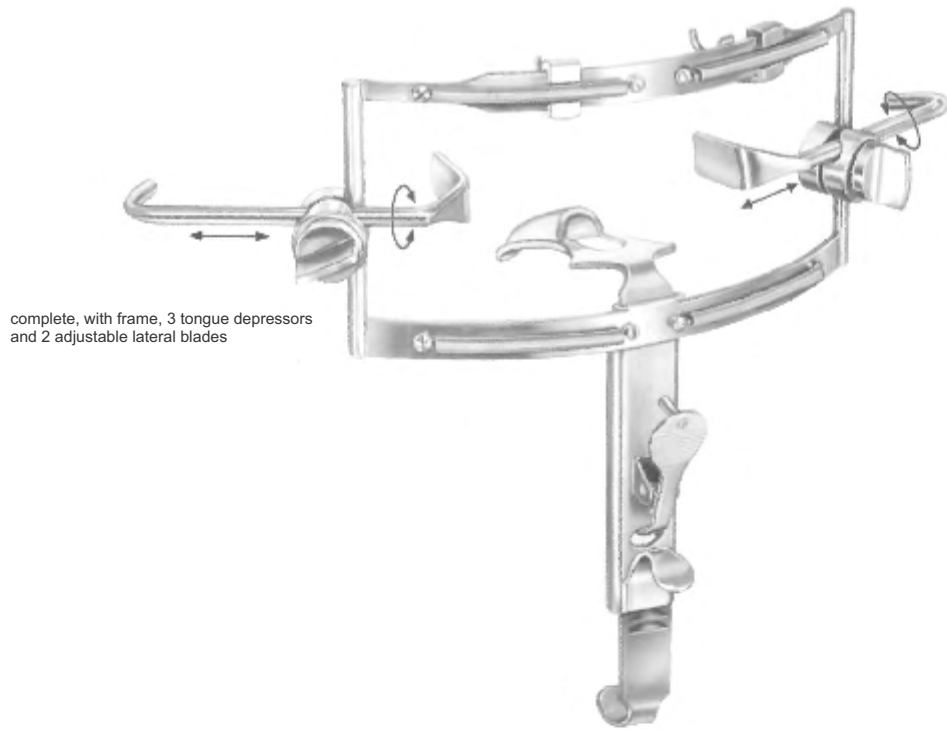

complete, with frame, 3 tongue depressors and 2 adjustable lateral blades

DINGMAN
FM- 17-4705-00
Complete set
Fig. 1 - 3

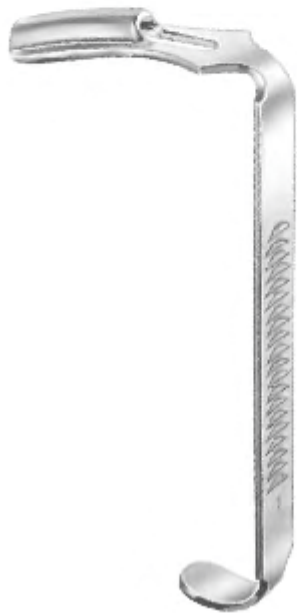

FM- 17-4706-01
62 mm x 26 mm



FM- 17-4707-02
65 mm x 30 mm



FM- 17-4708-03
78 mm x 32 mm

Tongue Depressors

EN	Mouth Gags
DE	Mundsperrer
ES	Abre-bocas
FR	Bouches de la bouche
IT	Bocca Gag



HEISTER
FM- 17-4709-13
13 cm/5 1/8"

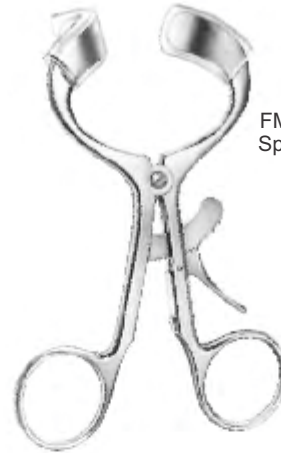

FM- 17-4711-11
Spare rubber

MOLT
FM- 17-4710-11
11 cm/4 3/8"



FM- 17-4713-13
Spare Rubber

MOLT
FM- 17-4712-13
13 cm/5 1/8"



FM- 17-4714-11
SPREADING
47 mm

OBWEGESER
FM- 17-4714-11
11 cm/4 3/8"

Mouth Gags	EN
Mundsperrer	DE
Abre-bocas	ES
Bouches de la bouche	FR
Bocca Gag	IT

17

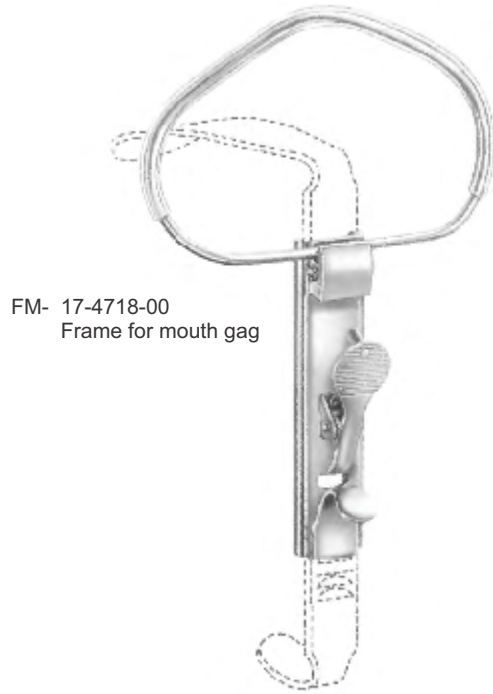

FM- 17-4718-00
Frame for mouth gag

McLVOR
FM- 17-4717-00
Complete with 3
tongue depressors

Tongue Depressors



Fig. 1
FM- 17-4719-01
100 x 25 mm



Fig. 2
FM- 17-4720-02
85 x 25 mm



Fig. 3
FM- 17-4721-03
75 x 25 mm

EN	Mouth Gags
DE	Mundsperrer
ES	Abre-bocas
FR	Bouches de la bouche
IT	Bocca Gag

FM- 17-4723-00
Frame for mouth gag



DAVIS-BOYLE
FM- 17-4722-00
Complete, consisting of frame
and 5 tongue depressors no. 1 - 5

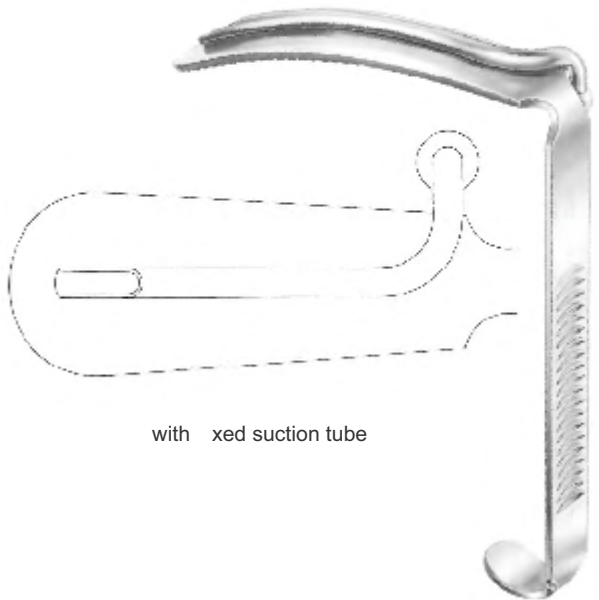

with fixed suction tube

Fig. 1
FM- 17-4724-01
110 x 28 mm



Fig. 2
FM- 17-4725-02
95 x 27 mm



Fig. 3
FM- 17-4726-03
80 x 27 mm



Fig. 4
FM- 17-4727-04
65 x 26 mm



Fig. 5
FM- 17-4728-05
30 x 20 mm

Mouth Gags	EN
Mundsperrer	DE
Abre-bocas	ES
Bouches de la bouche	FR
Bocca Gag	IT

17

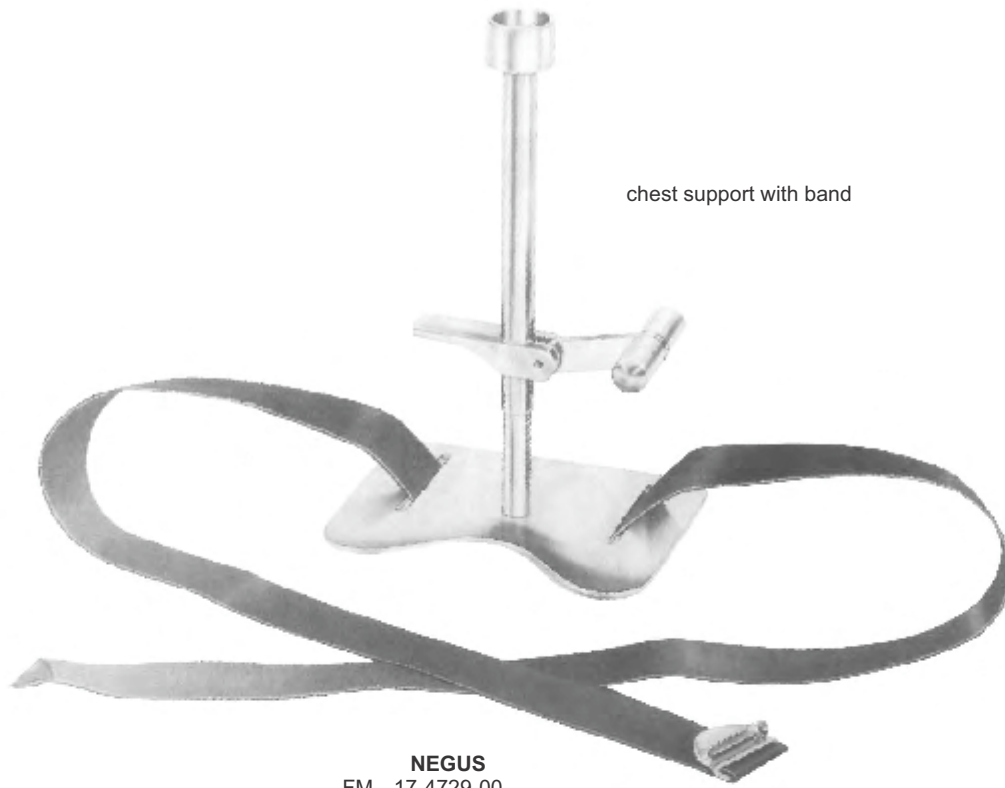

chest support with band

NEGUS
FM- 17-4729-00



FM- 17-4731
Frame for mouth gag

KILNER-DOUGHTY
FM- 17-4730-00



Fig. 1
FM- 17-4732-13
13.5 cm/5 3/8"
29 x 70 mm



Fig. 2
FM- 17-4733-13
13.5 cm/5 3/8"
34 x 80 mm



PALATE PLTE
FM- 17-4734-00



Fig. 3
FM- 17-4735-13
13.5 cm/5 3/8"
38 x 85 mm

complete, consisting of frame and 3 tongue depressors
no. 1 to 3, 2 tooth plates and 1 palate plate

EN	Mouth Gags
DE	Mundsperrer
ES	Abre-bocas
FR	Bouches de la bouche
IT	Bocca Gag



NEUKAM
FM- 17-4737-00
frame for mouth gag only

NEUKAM
FM- 17-4736-00
complete with frame and
3 tongue depressors

Tongue Depressor
fenestrated blade for suction



Fig. 1
FM- 17-4738-01

Fig. 2
FM- 17-4739-02

Fig. 3
FM- 17-4740-03

Tongue Holding Forceps	EN
Zungenzangen	DE
Pinzas Tira-lengua	ES
Bouches de la bouche	FR
Bocca Gag	IT

17



COLLIN
FM- 17-4741-16 16 cm/6 ¼"
FM- 17-4741-18 18 cm/7 ½"

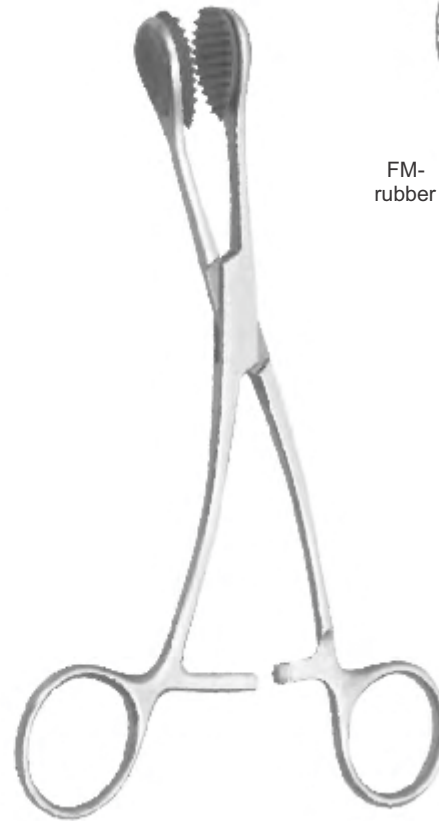

YOUNG
FM- 17-4742-16
16 cm/6 ¼"



FM- 17-4743-16
rubber inserts, only (pair)

EN	Tongue Spatulas
DE	Zungenspatel
ES	Espátulas Linguales
FR	Spatules de langue
IT	Spatole di lingua



FM- 17-4744-15
15 cm/5 7/8"
wood
19 mm



FM- 17-4745-15
15 cm/5 7/8"
plastic



BRUNINGS
FM- 17-4746-19
19 cm/7 1/2"



16 mm
FM- 17-4747-14
14.5 cm/5 3/4"



19 mm

23 mm

FM- 17-4748-14
14 cm/5 1/2"



DOYEN

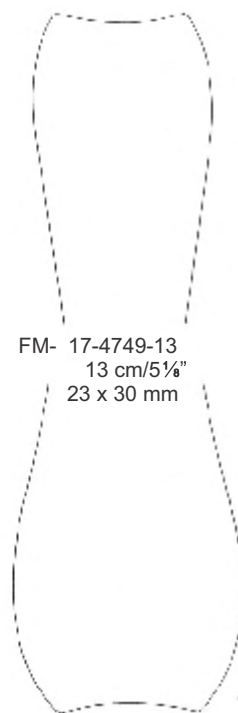

FM- 17-4749-13
13 cm/5 1/8"
23 x 30 mm

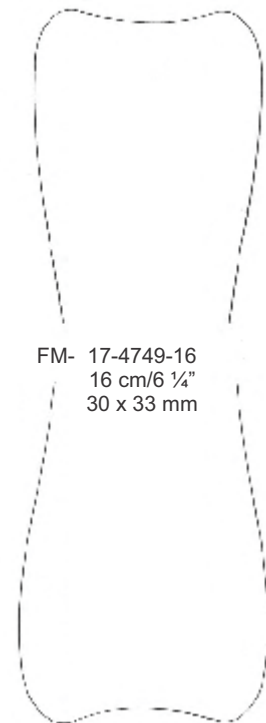

FM- 17-4749-16
16 cm/6 1/4"
30 x 33 mm

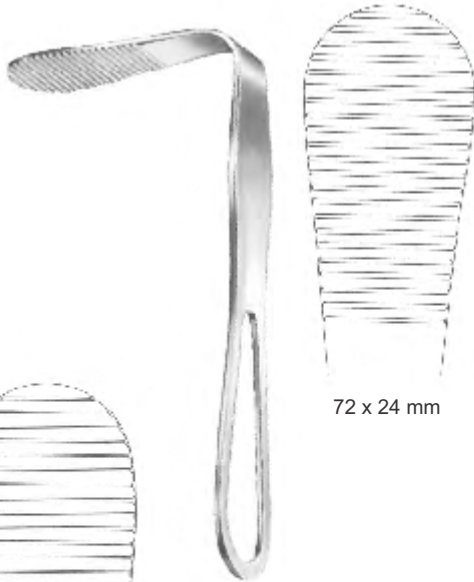

72 x 24 mm

HARTMANN
 FM- 17-4751-15
 15 cm/5 7/8"



83 x 25 mm

TOBOLD
 FM- 17-4752-16
 16 cm/6 1/4"



80 x 25 mm

TOBOLD
 FM- 17-4750-15
 15 cm/5 7/8"



FM- 17-4755-14
 14 cm/5 1/2"
 36 mm



BUCHWALD
 FM- 17-4753-18
 18 cm/7 1/8"



ANDREW
 FM- 17-4754-11
 11 cm/4 3/8"

WIEDER

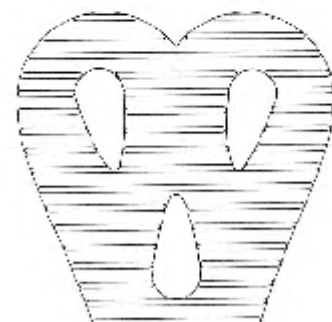

FM- 17-4755-15
 15 cm/5 7/8"
 43 mm



MARTIN-SIMPLEX
 FM- 17-4756-10
 10.5 cm/4 1/8"



FM- 17-4757-14
 14 cm/5 1/2"
 Vestibulum retractor



STERNBERG
 FM- 17-4758-14
 14 cm/5 1/2"

26 mm

37 mm

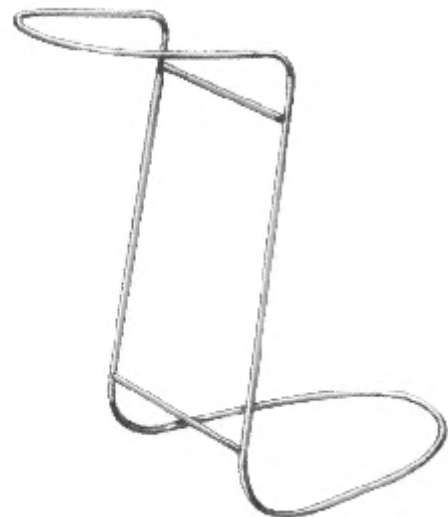

OBWEGESER
 FM- 17-4759-12
 12 cm/4 3/4"



BISHOP
 FM- 17-4760-13
 13.5 cm/5 3/8"



CAWOOD-MINNESOTA
 FM- 17-4761-15
 15.5 cm/6 1/8"



CAWOOD-MINNESOTA
 FM- 17-4762-14
 14.5 cm/5 3/4"



Ramus retractors, Chin Retractor, Channel Retractors **EN**

Ramushaken, kinnhalter, Progenierinnen **DE**

Separadores para el ramo, Gancho de menton, Separadores mandibulares **ES**

Écarteurs de Ramus, Écarteur de menton, Écarteurs de canal **FR**

Divaricatori Ramus, Divaricatore a mento, Divaricatori a canale **IT**

17



FAIZAN & MUSA
SPECIAL INSTRUMENTS

ORAL INSTRUMENTS

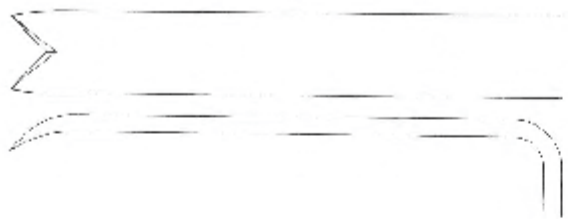

72 x 10 mm



OBWEGESER
FM- 17-4763-22
22 cm/8 3/4"



OBWEGESER
FM- 17-4764-16
16.5 cm/6 1/2"



OBWEGESER
FM- 17-4765-16
16 cm/6 1/4"
8 mm

OBWEGESER
FM- 17-4766-16
16 cm/6 1/4"
10 mm

EN	Soft Tissue Retractors
DE	Weichteilhaken
ES	Separadores para partes blandas
FR	Écarteurs de tissus mous
IT	Divaricatori di tessuti molli



FM- 17-4767-22
22.5 cm/8 3/4"
43 x 11 mm



FM- 17-4767-23
23 cm/9"
57 x 11 mm



FM- 17-4768-23
23 cm/9"
80 x 16 mm

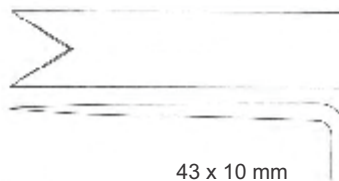

43 x 10 mm



OBWEGESER



OBWEGESER
FM- 17-4769-22
22 cm/8 3/4"
Nasal Spine Retractor

Periosteal Elevators **EN**
 Raspatorien **DE**
 Periostotomos **ES**
 Ascenseurs périostés **FR**
 Ascensori periostale **IT**

17



ORAL INSTRUMENTS



OBWEGESER
 17.5 cm/6 7/8"

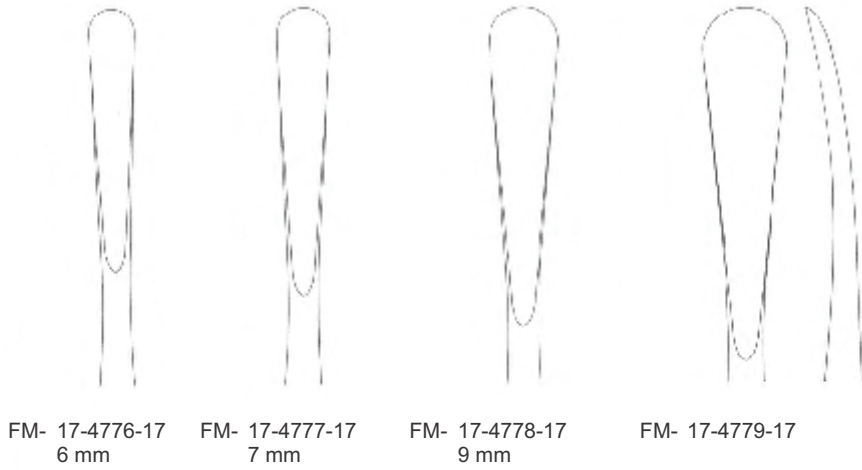

FM- 17-4776-17
 6 mm

FM- 17-4777-17
 7 mm

FM- 17-4778-17
 9 mm

FM- 17-4779-17



OBWEGESER
 20 cm/7 7/8"

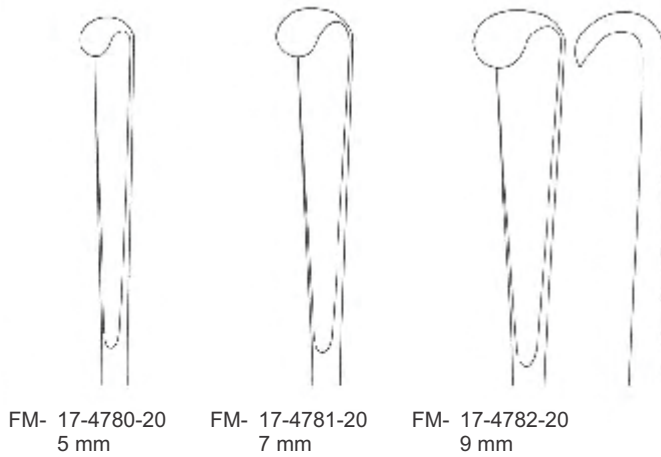

FM- 17-4780-20
 5 mm

FM- 17-4781-20
 7 mm

FM- 17-4782-20
 9 mm

- EN** Stomach, Intestine, Rectum
- DE** Magen, Darm, Mastdarm
- ES** Estómago, Intestinos, Recto
- FR** Estomac, Intestin, Rectum
- IT** Stomaco, intestino, retto

Page 238 to 251



EN Tissue Seizing, Intestinal Atrauma Tissue Forceps
 DE Tissue Beschlagnahme, Darm Atrauma Tissue Zange
 ES Aprovechando el tejido intestinal y pinzas de tejido Atrauma
 FR Saisie de tissu, pincés à tissus intestinales Atrauma
 IT Cattura del tessuto, pinza del tessuto intestinale Atrauma



STOMACH, INTESTINE & RECTUM



Allis

cm	in	4 : 5		5 : 6	
15	6"	FM- 18-4801-15	FM- 18-4802-15		
19	7½"	FM- 18-4801-19	FM- 18-4802-19		
23	9"	FM- 18-4801-23	FM- 18-4802-23		
25	10"	FM- 18-4801-25	FM- 18-4802-25		



Baby-Allis

FM- 18-4803-12	12 cm/4¾"
FM- 18-4803-14	14 cm/5½"



Allis-Atrauma

FM- 18-4804-16	16 cm/6¼"
FM- 18-4804-20	20 cm/8"
FM- 18-4804-25	25 cm/10"
FM- 18-4804-30	30 cm/12"



Allis-Adair

FM- 18-4805-15	15 cm/6"
----------------	----------



Boys-Allis

FM- 18-4806-15	15 cm/6"
----------------	----------



Lockwood-Allis

FM- 18-4807-16	16 cm/6¼"
FM- 18-4807-20	20 cm/8"



Thoms-Allis

FM- 18-4808-20	20 cm/8"
----------------	----------



FAIZAN & MUSA
SPECIAL INSTRUMENTS

18

Tissue Seizing, Intestinal Atrauma Tissue Forceps EN

Tissue Beschlagnahme, Darm Atrauma Tissue Zange DE

Aprovechando el tejido intestinal y pinzas de tejido Atrauma ES

Saisie de tissu, pincers à tissus intestinales Atrauma FR

Cattura del tessuto, pinza del tessuto intestinale Atrauma IT

STOMACH, INTESTINE & RECTUM



3:4

Judd-Allis

FM- 18-4809-15 15 cm/6"
FM- 18-4809-19 19 cm/7½"



Littlewood

FM- 18-4810-18
FM- 18.5 cm/7¼"



Williams

FM- 18-4811-16
FM- 16 cm/6¼"



Lockwood

FM- 18-4812-20
20 cm/8"

Atrauma



cm/in **Babcock-Atrauma**
16 cm/6¼" FM- 18-4813-16
18 cm/7"
20 cm/8" FM- 18-4813-20
24 cm/9½"



Babcock(Standard)
FM- 18-4814-16
FM- 18-4814-18
FM- 18-4814-20
FM- 18-4814-24



Baby-Babcock
FM- 18-4815-16

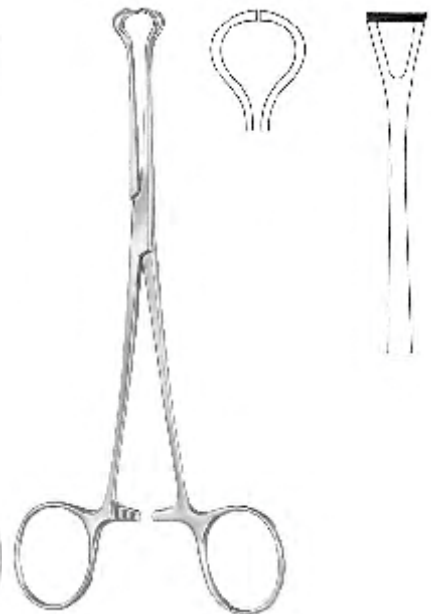

Babcock
FM- 18-4816-16
FM- 18-4816-18
FM- 18-4816-20
FM- 18-4816-24

EN Intestinal Tissue and Organ Grasping Forceps
 DE Gewebe- und organ-Faßzangen
 ES Pinzas para tejidos y órganos
 FR Pince à saisir les tissus intestinaux et les organes
 IT Forcipe per afferrare il tessuto intestinale e l'organo

STOMACH, INTESTINE & RECTUM

Atrauma

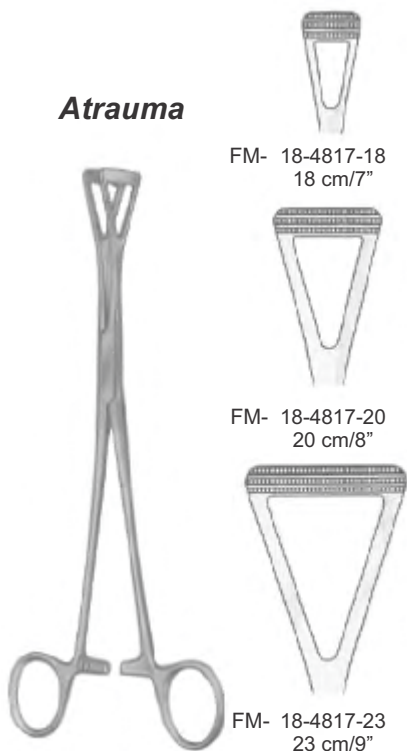

Duval
 cm in
 FM- 18-4818-18 18 7" FM- 18-4819-18
 FM- 18-4818-20 20 8" FM- 18-4819-20
 FM- 18-4818-23 23 9" FM- 18-4819-23

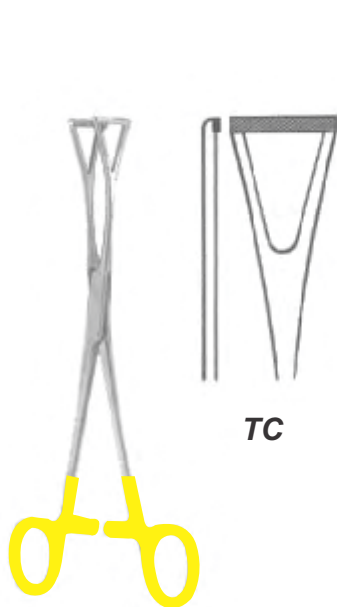

Duval
 FM- 18-4820-20
 20 cm/8"



Child
 FM- 18-4821-24
 24 cm/9½"

Atrauma

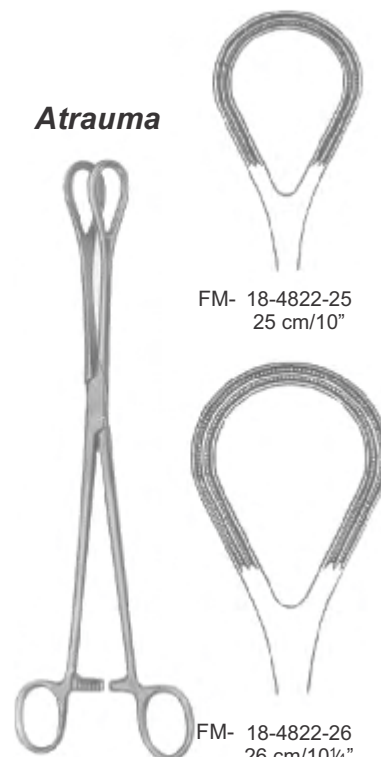

FM- 18-4822-25
 25 cm/10"

FM- 18-4822-26
 26 cm/10¼"

Intestinal Clamps Forceps EN

Darmklemmen DE

Pinzas-clamps intestinales ES

Pinces pour clamps intestinaux FR

Pinze per morsetto intestinale IT

18



FAIZAN & MUSA
SPECIAL INSTRUMENTS

STOMACH, INTESTINE & RECTUM

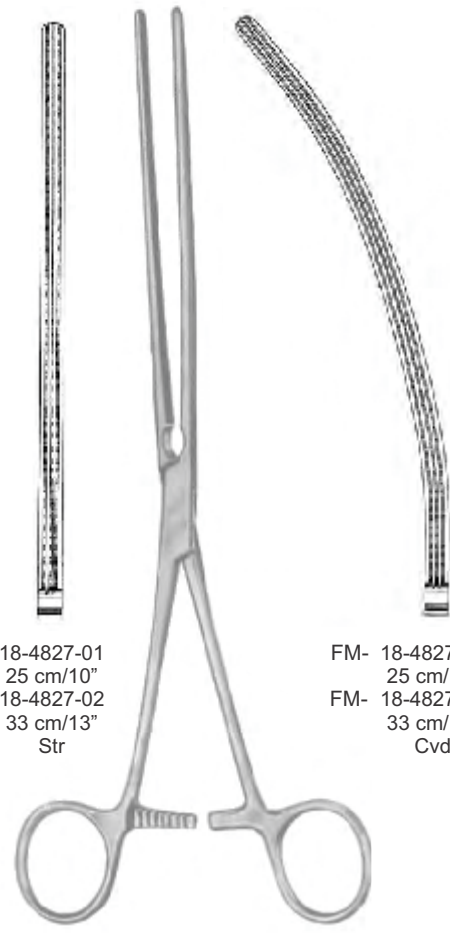
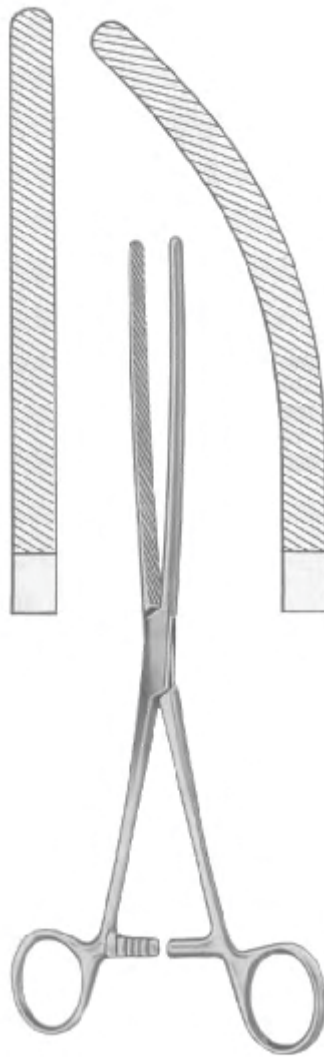
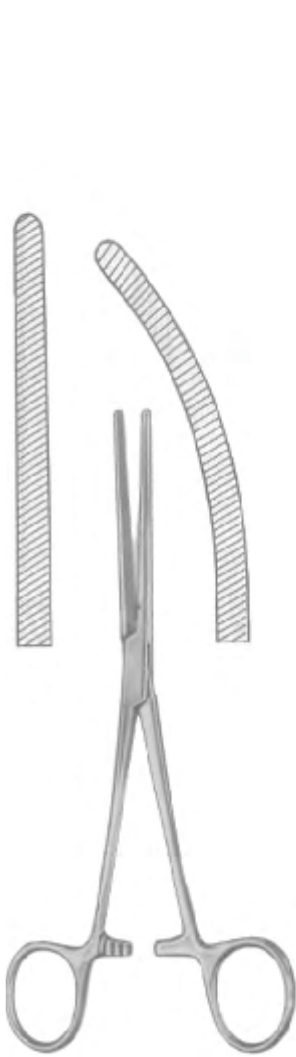

Baby-Doyen

Straight	Curved
FM- 18-4823-18	FM- 18-4824-18
18 cm/7"	18 cm/7"

Doyen

Straight	Curved
FM- 18-4825-21	FM- 18-4826-21
21 cm/8 1/4"	21 cm/8 1/4"
FM- 18-4825-23	FM- 18-4826-23
23 cm/9"	23 cm/9"

FM- 18-4827-01
25 cm/10"
FM- 18-4827-02
33 cm/13"
Str

FM- 18-4827-03
25 cm/10"
FM- 18-4827-04
33 cm/13"
Cvd

Scudder

- EN Atrauma Intestinal Clamps Forceps
- DE Atrauma Darmklemmen
- ES Atrauma pinzas-clamps intestinales
- FR Atrauma Intestinal Clamps Forceps
- IT Pinze per pinze intestinali Atrauma

Atrauma



Doyen-Atrauma

Straight

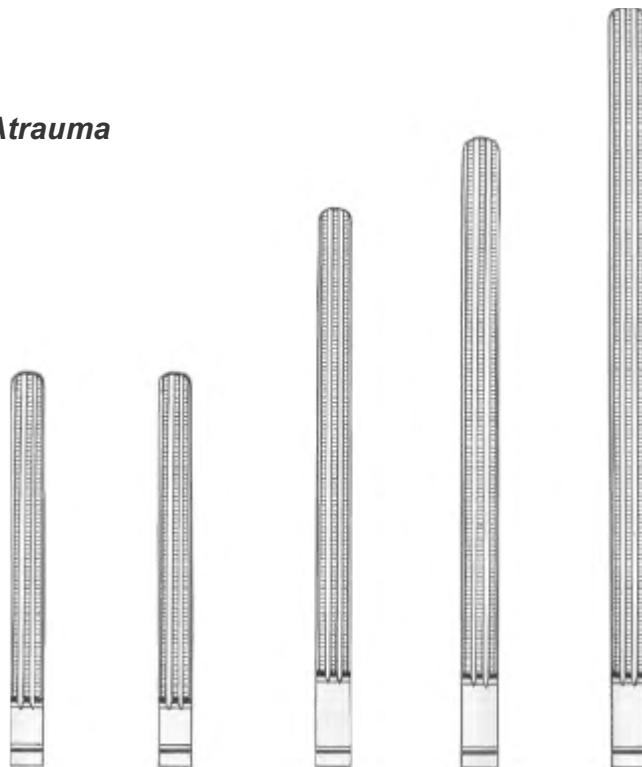

- FM- 18-4828-13FM- 13 cm/5"
- 18-4828-16FM- 16 cm/6¼"
- 18-4828-18FM- 18 cm/7"
- 18-4828-21FM- 21 cm/8¼"
- 18-4828-23FM- 23 cm/9"

Curved

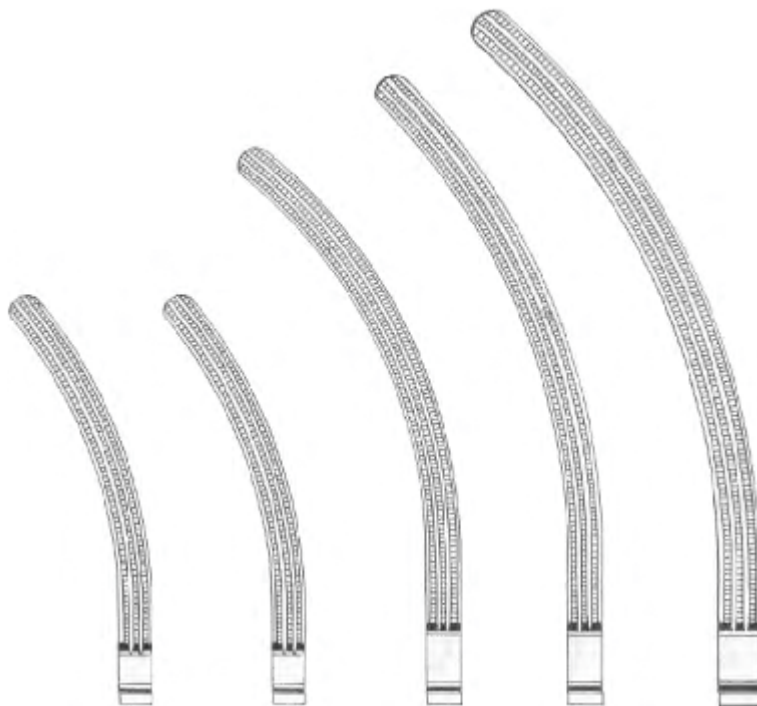

- FM- 18-4829-13FM- 13 cm/5"
- 18-4829-16FM- 16 cm/6¼"
- 18-4829-18FM- 18 cm/7"
- 18-4829-21FM- 21 cm/8¼"
- 18-4829-23FM- 23 cm/9"

Atrauma Intestinal Clamps Forceps **EN**
 Atrauma Darmklemmen **DE**
 Atrauma pinzas-clamps intestinales **ES**
 Atrauma Intestinal Clamps Forceps **FR**
 Pinze per pinze intestinali Atrauma **IT**

18



STOMACH, INTESTINE & RECTUM

Atrauma

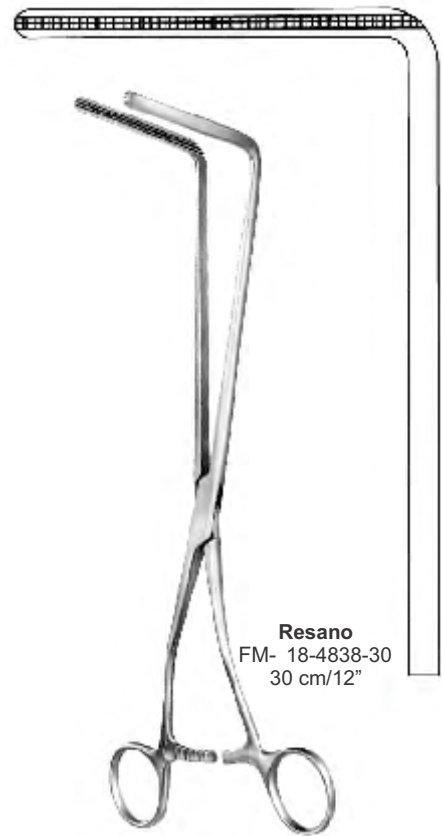

Resano
 FM- 18-4838-30
 30 cm/12"



Hayes



FM- 18-4839-26
 26 cm/10 1/4"

FM- 18-4840-28
 28 cm/11"



Fehland
 FM- 18-4841-24
 24 cm/9 1/2"

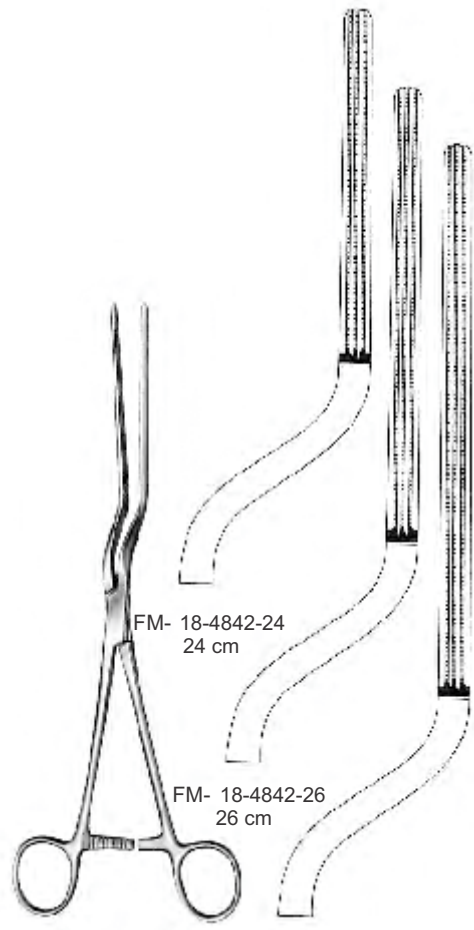

FM- 18-4842-24
 24 cm

FM- 18-4842-26
 26 cm

- EN Atrauma Intestinal Clamps Forceps
- DE Atrauma Darmklemmen
- ES Atrauma pinzas-clamps intestinales
- FR Atrauma Intestinal Clamps Forceps
- IT Pinze per pinze intestinali Atrauma

Atrauma

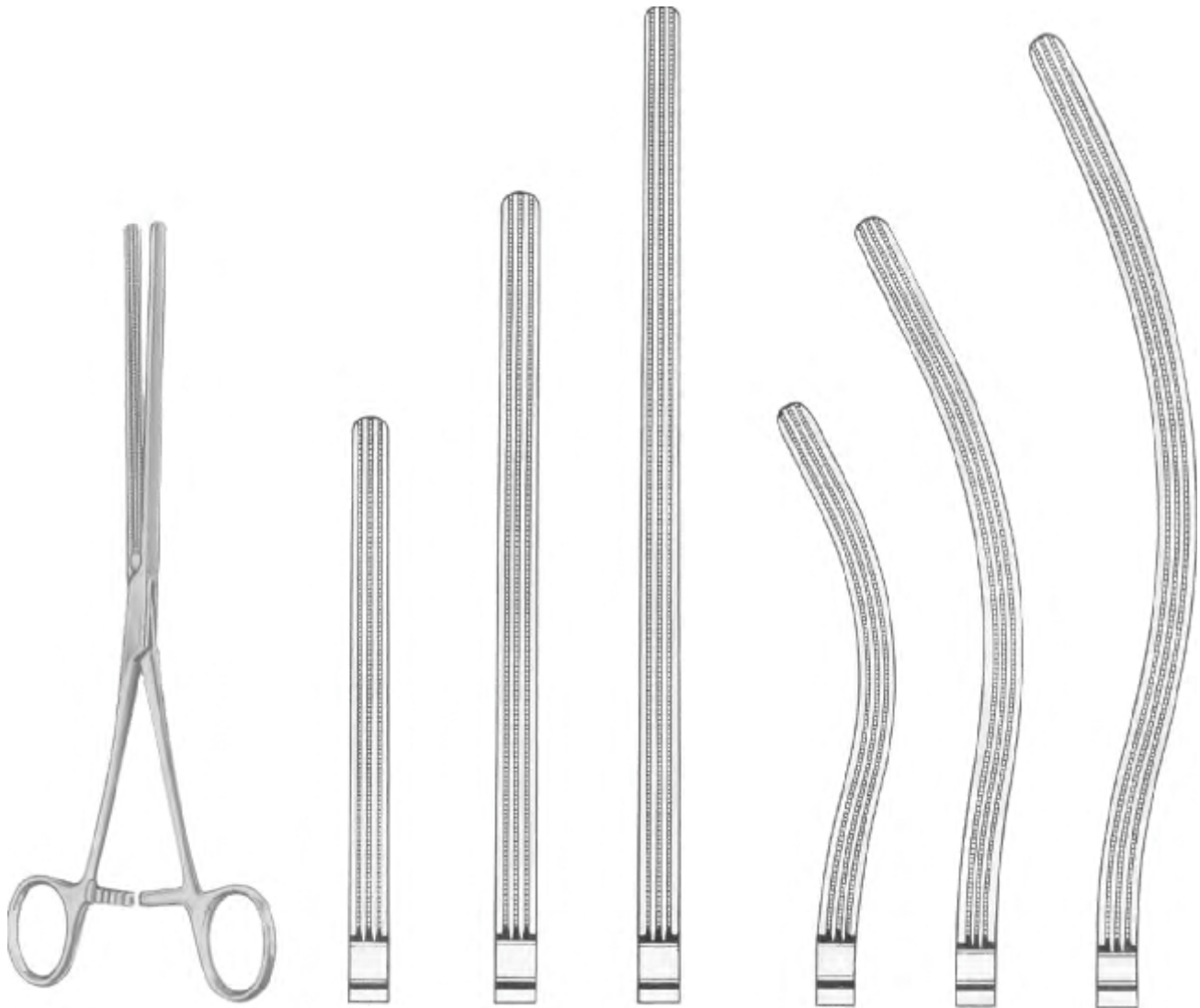

Kocher-Atrauma

- | | | | | | |
|----------------|----------------|----------------|----------------|----------------|----------------|
| FM- 18-4848-22 | FM- 18-4848-25 | FM- 18-4848-28 | FM- 18-4849-22 | FM- 18-4849-25 | FM- 18-4849-28 |
| 22 cm/8¾" | 25 cm/10" | 28 cm/11" | 22 cm/8¾" | 25 cm/10" | 28 cm/11" |

Intestinal Clamps Forceps EN

Darmklemmen DE

Pinzas-clamps intestinales ES

Pinces pour clamps intestinaux FR

Pinze per morsetto intestinale IT

18



FAIZAN & MUSA
SPECIAL INSTRUMENTS

STOMACH, INTESTINE & RECTUM



Straight
FM- 18-4851-25
FM- 18-4851-30



Nussbaum
25 cm/10"
30 cm/12"



Curved
FM- 18-4852-25
FM- 18-4852-30



Pylorus spreader

Benson
FM- 18-4850-15
15.5 cm/6"

Blindgut forceps



Allen
FM- 18-4853-15 15.5 cm/6"
FM- 18-4853-20 20.0 cm/8"



Kleinschmidt
FM- 18-4854-12
12 cm/4¾"

- EN Intestinal Stomach Clamps
- DE Darm- und Magenklappen
- ES Pinzas-clamps intestinales y estomacales
- FR Pincas intestinales intestinales
- IT Morsetti per stomaco intestinale

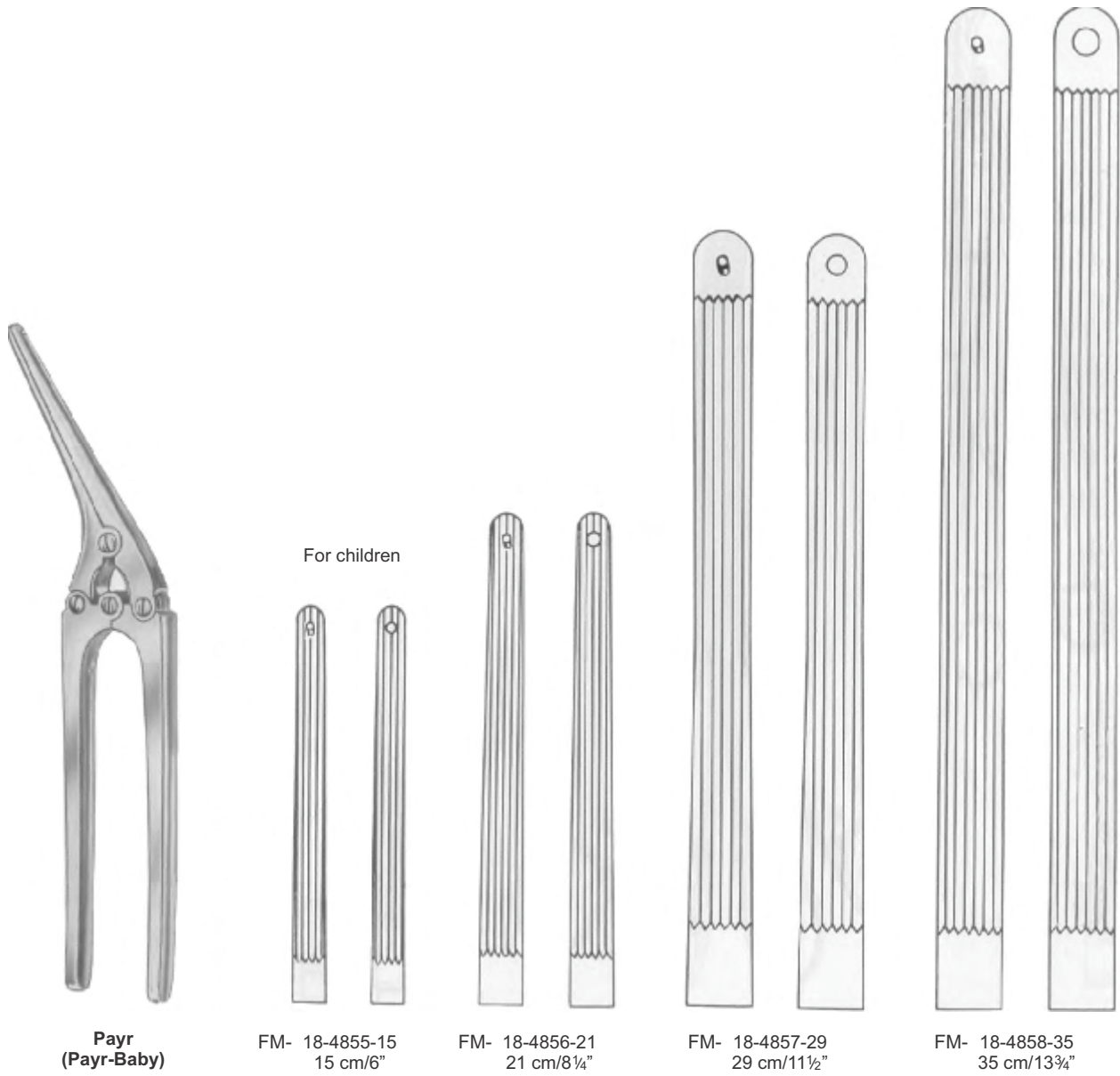

**Payr
(Payr-Baby)**

FM- 18-4855-15
15 cm/6"

FM- 18-4856-21
21 cm/8 1/4"

FM- 18-4857-29
29 cm/11 1/2"

FM- 18-4858-35
35 cm/13 3/4"

Intestinal Clamps Forceps	EN
Darmklemmen	DE
Pinzas-clamps intestinales	ES
Pinces intestinales intestinales	FR
Morsetti per stomaco intestinale	IT

Twin Clamps Forceps



Lane
30 cm/12"



Straight
FM- 18-4859-30

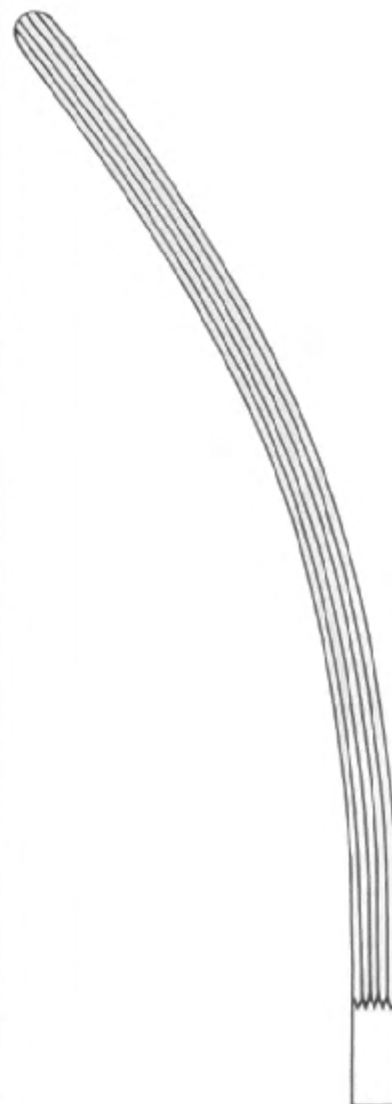

Curved
FM- 18-4860-30



MOD. MARTIN
 FM- 18-4877-01 22mm Ø X 50mm
 FM- 18-4877-02 22mm Ø X 75mm
 FM- 18-4877-03 22mm Ø X 100mm



NEWMAN
 FM- 18-4878-01 16mm Ø X 63mm
 FM- 18-4878-02 19mm Ø X 63mm
 FM- 18-4878-03 23mm Ø X 63mm



BENSUADE
 FM- 18-4879-01 19mmØ X 70mm
 FM- 18-4879-02 22mmØ X 70mm

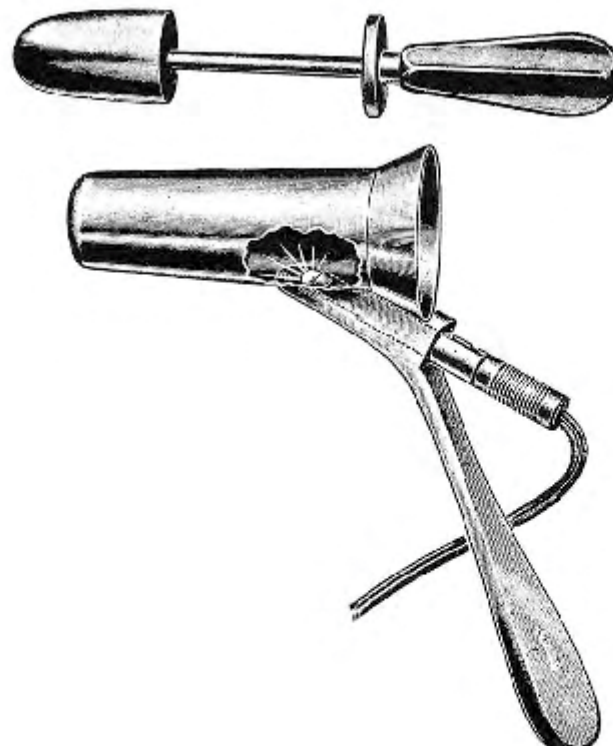

NAUNTON-MORGAN
 FM- 18-4880-00
 22mmØ X 70mm

Rectal Specula, Anal Retractors	EN
Mastdarm-Spekule, -Spreizer-Analspreizer	DE
Especulos rectales	ES
Spéculums rectaux, rétracteurs anaux	FR
Specula rettale, Divaricatori anali	IT

18

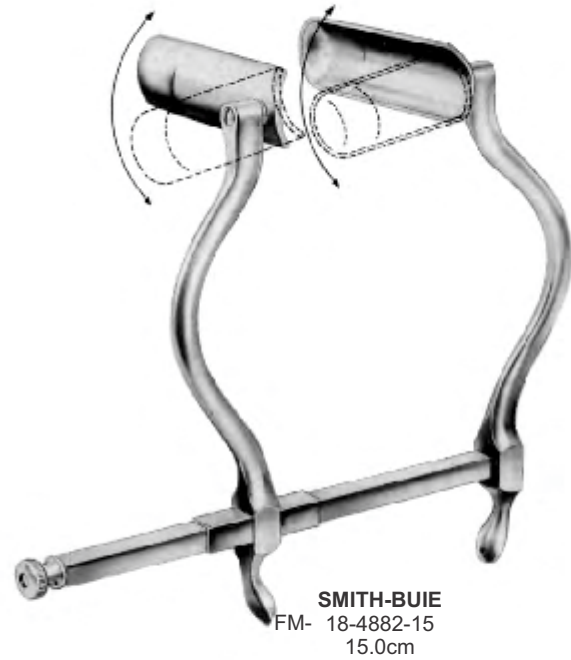

FM- 18-4883-00 complete
FM- 18-4883-04 centre blade
FM- 18-4883-13 frame only



- EN Rectal Biopsy Specimen Forceps
- DE Mastdarm-Biopsiezange,
- ES Pinza sacabocado para biopsia rectal
- FR Pince à spécimen de biopsie rectale
- IT Pinze per campioni per biopsia rettale



FAIZAN & MUSA
SPECIAL INSTRUMENTS

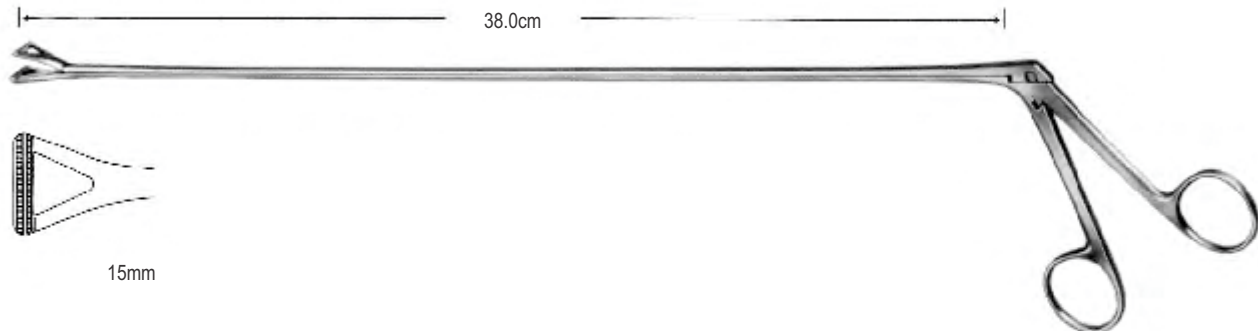

FM- 18-4905-38

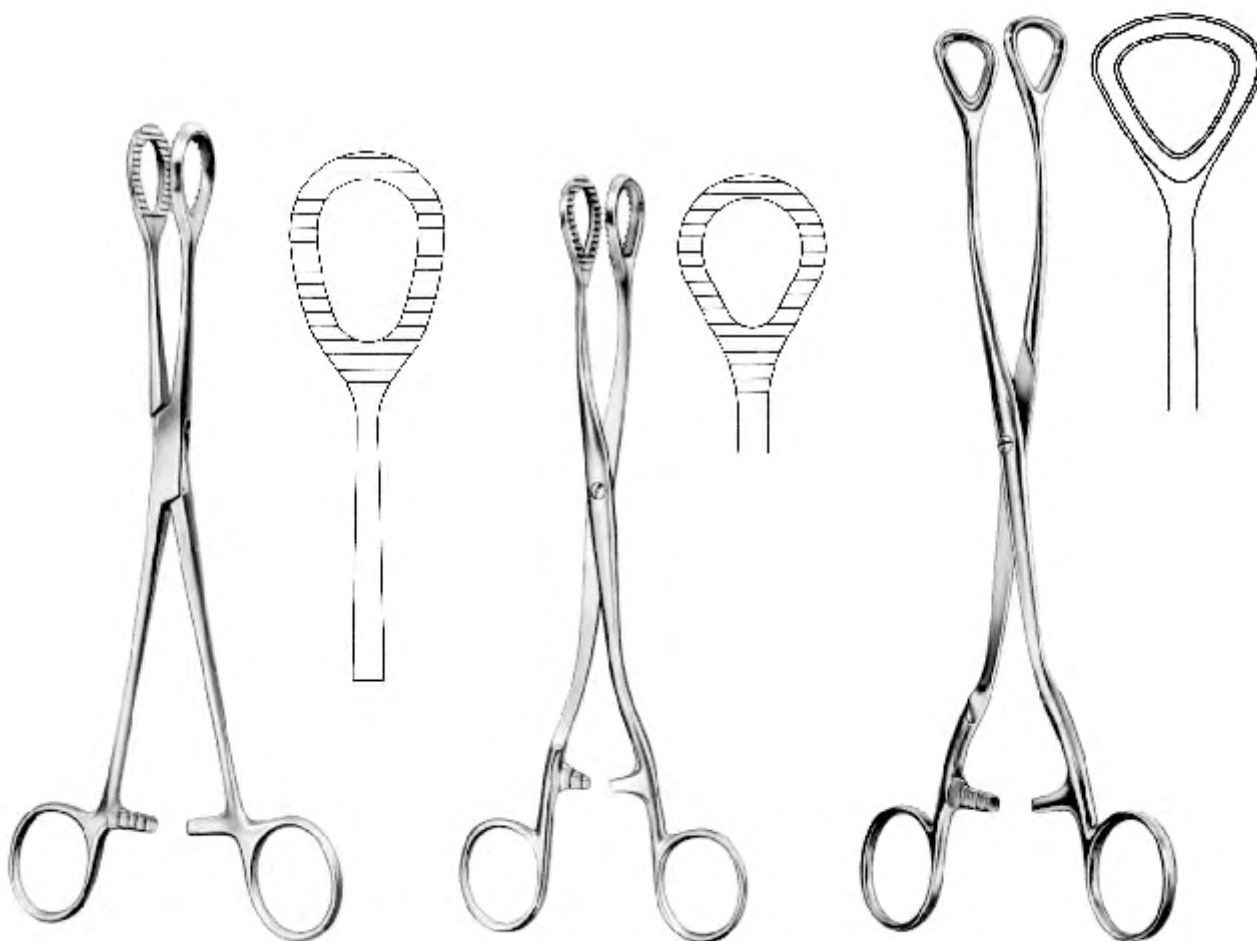

HEYWOOD-SMITH
FM- 18-4906-21
21.0cm

HEYWOOD-SMITH
FM- 18-4907-20
20.0cm

LUER
FM- 18-4908-24
24.5cm

Rectal Biopsy Forceps **EN**
 Mastdarm-Biopsiezange **DE**
 Pinzas sacabocado p / biopsia rectal ligaduras **ES**
 Pince à biopsie rectale **FR**
 Pinze per biopsia rettale **IT**

18



STOMACH, INTESTINE & RECTUM

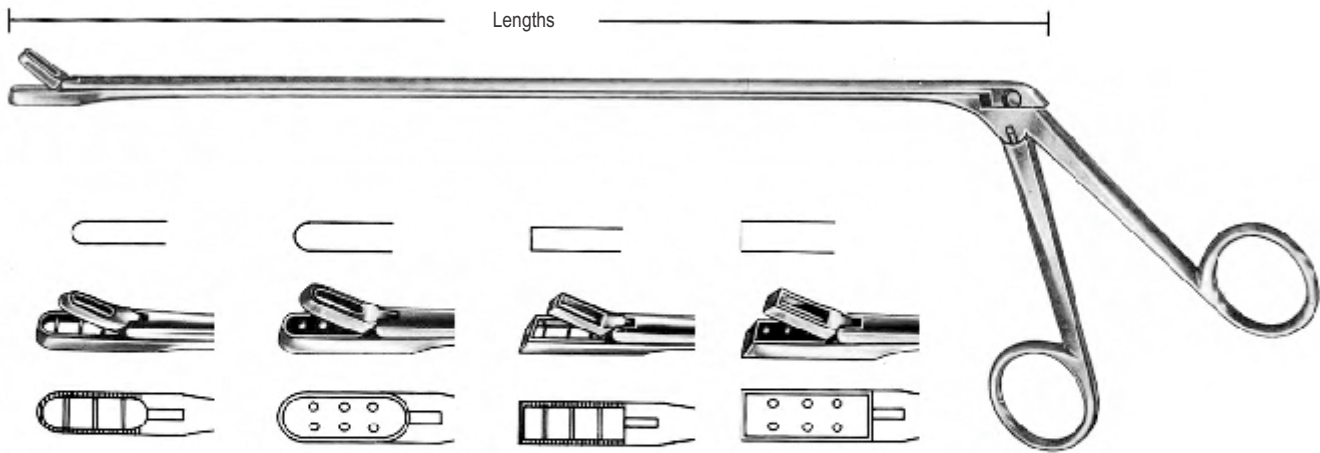
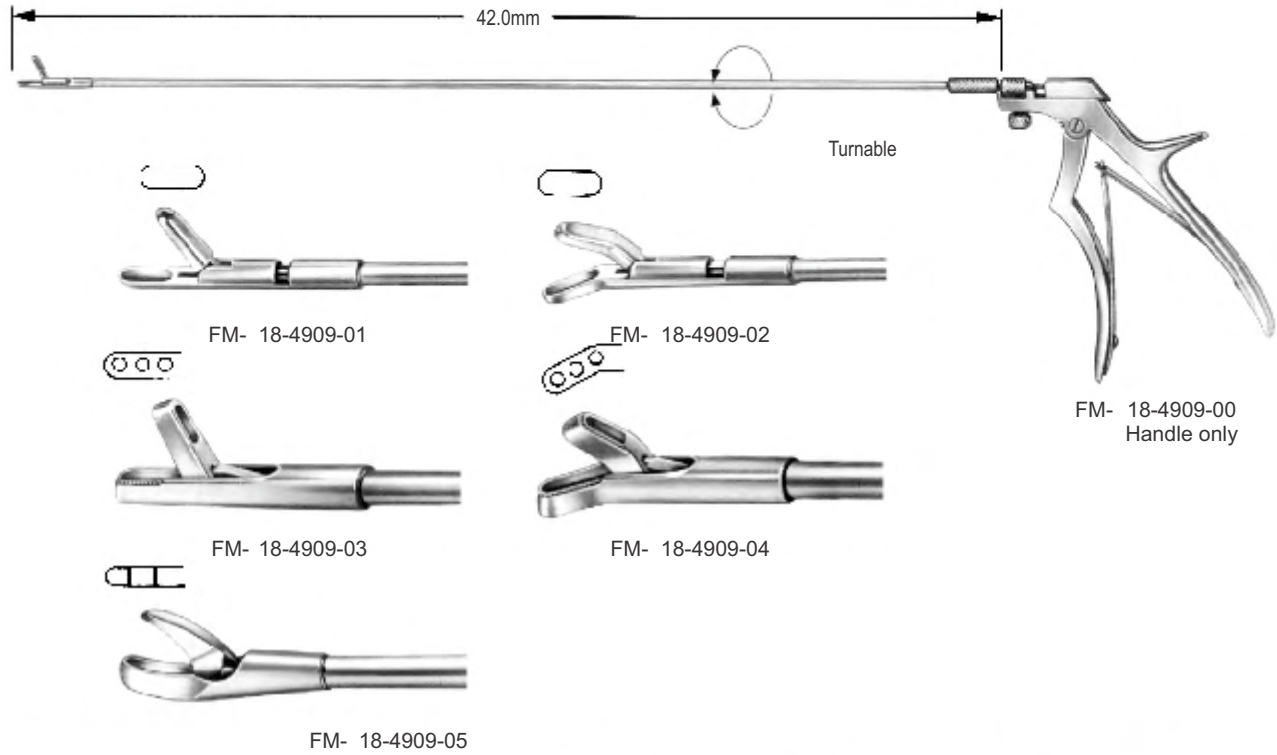

L/shaft	FM- 18-4910-28	FM- 18-4911-28	FM- 18-4912-28	FM- 18-4913-28
28.0cm	FM- 18-4910-28	FM- 18-4911-28	FM- 18-4912-28	FM- 18-4913-28
35.0cm	FM- 18-4910-35	FM- 18-4911-35	FM- 18-4912-35	FM- 18-4913-35
42.0cm	FM- 18-4910-42	FM- 18-4911-42	FM- 18-4912-42	FM- 18-4913-42

EN Kidney, Liver, Gall Stone, Urology

DE Niere, Leber, Galle, Urologie

ES Riñón, Hígado, Bilis, Urología

FR Reins, foie, calculs biliaires

IT Rene, fegato, pietra gallica

Page 252 to 262



EN	Kidney Pedicle Clamp Forceps
DE	Kidney Gestielte Klammerzange
ES	Pinzas de riñón Clamp pediculares
FR	Pince pour pédicule pédiculaire rein
IT	Pinze per morsetto per reni



Guyon

FM- 19-5001-20
20 cm/8"

FM- 19-5001-22
22 cm/8¾"

FM- 19-5001-24
24 cm/9½"

FM- 19-5002-23
23 cm/9"

FM- 19-5002-24
24 cm/9½"

Atrauma



Guyon
FM- 19-5003-23
23 cm/9"

Nephrostomy Forceps and Kidney Stones **EN**
 Nieren stelzangen, Gallensteinzangen **DE**
 Pinza para nefrostomía, pinzas para cálculos biliares **ES**
 Forceps de néphrostomie et calculs rénaux **FR**
 Forcipe per nefrostomia e calcoli renali **IT**

19



KIDNEY, UROLOGY



Elsasser
 FM- 19-5007-20
 20 cm/8"



FM- 19-5008-20
 20 cm/8"

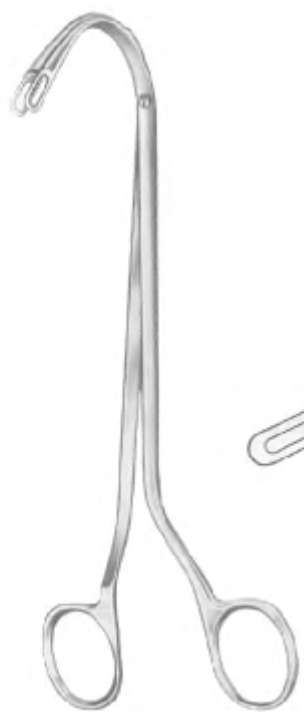

Randall

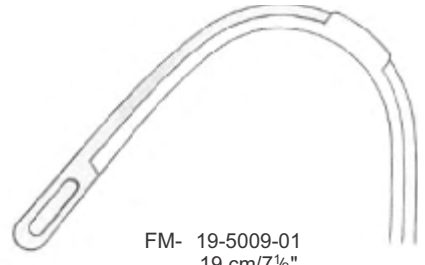

FM- 19-5009-01
 19 cm/7½"

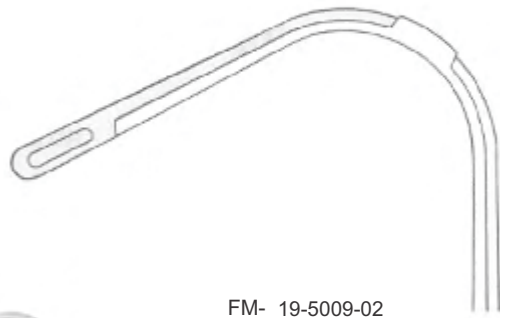

FM- 19-5009-02
 19 cm/7½"



Randall



Fig. 4
 FM- 19-5010-04
 22 cm/8¾"

Fig. 3
 FM- 19-5010-03
 22 cm/8¾"

Fig. 2
 FM- 19-5010-02
 22 cm/8¾"

Fig. 1
 FM- 19-5010-01
 23 cm/9"

EN	Gall Duct Forceps
DE	Gall Duct Zange
ES	Pinzas conducto biliar
FR	Pince à goulotte
IT	Pinza per condotti Gall



Fig. 1
FM- 19-5011-01 22 cm/8¾"

Fig. 2
FM- 19-5011-02 23 cm/9"

Set of 2 pieces



Fig. 1
FM- 19-5012-01 22 cm/8¾"

Fig. 2
FM- 19-5012-02 23 cm/9"

Set of 2 pieces

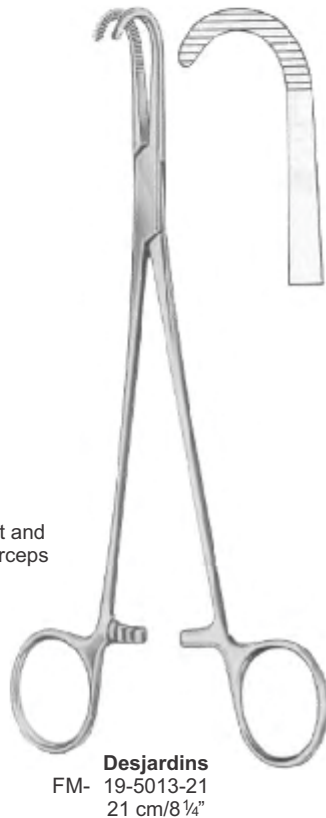

Gall duct and cystic forceps



Gall Stone Forceps EN

Gallensteinzngen DE

Pinzas para cálculo biliares ES

Pince en pierre de Gall FR

Forcella di pietra di Gall IT

19



FAIZAN & MUSA
SPECIAL INSTRUMENTS



Straight
FM- 19-5017-20

Mayo-Blake
20 cm/8"



Curved
FM- 19-5018-20

Mayo-Blake
20 cm/8"



Czerny
FM- 19-5019-24
24.5 cm/9 3/4"

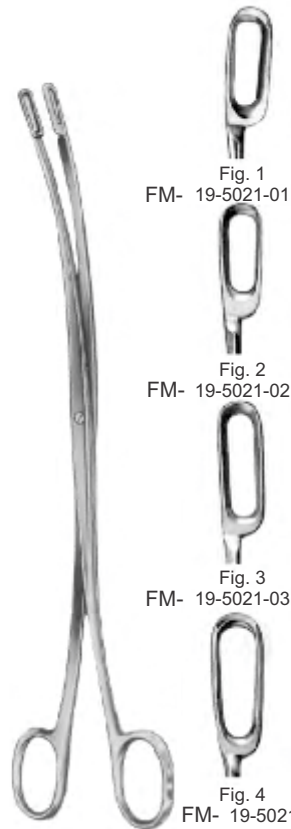

Fig. 1
FM- 19-5021-01

Fig. 2
FM- 19-5021-02

Fig. 3
FM- 19-5021-03

Fig. 4
FM- 19-5021-04

Desjardins

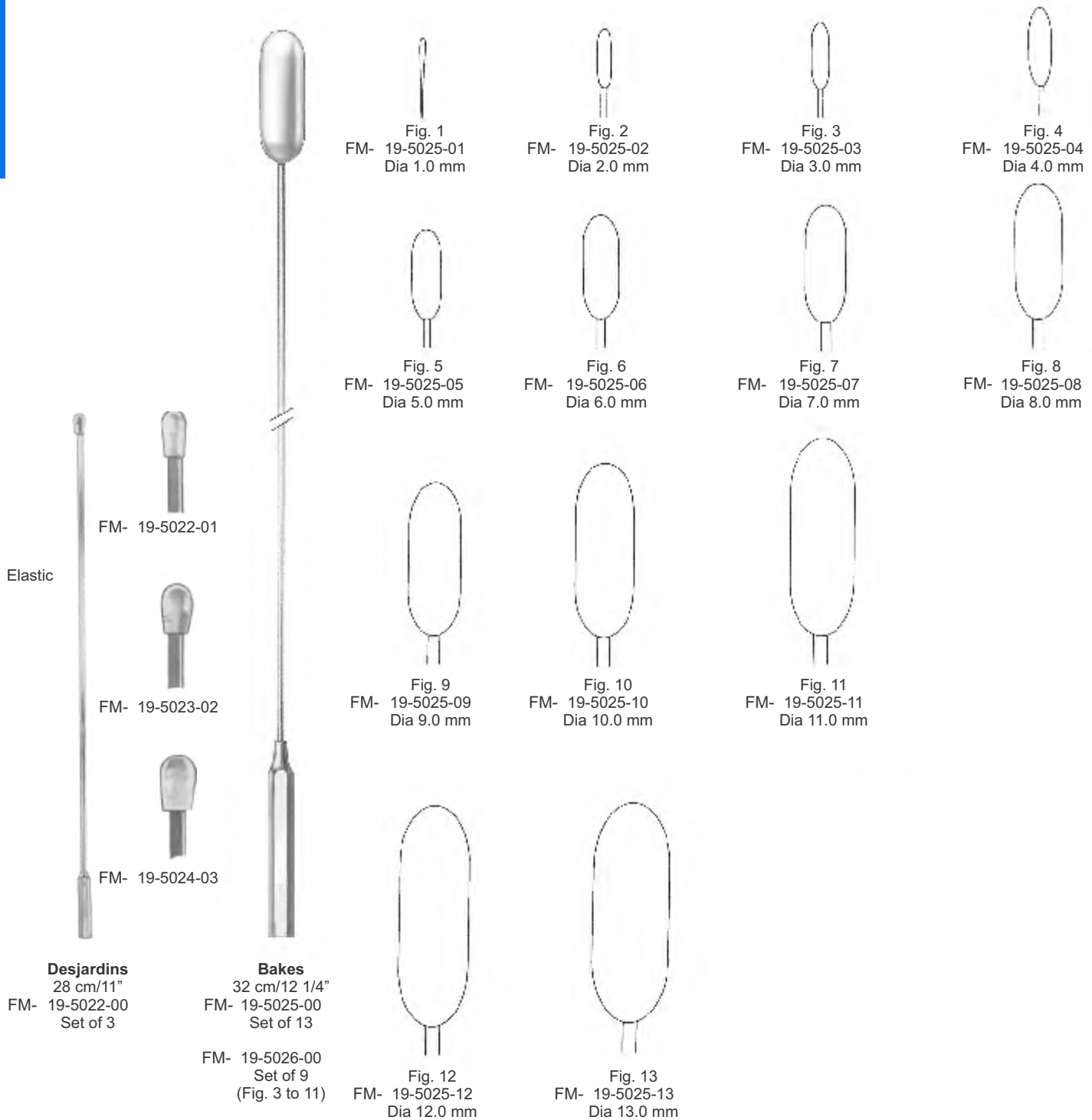

Gall Stone Forceps EN

Gallensteinzngen DE

Pinzas para cálculo biliares ES

Pince en pierre de Gall FR

Forcella di pietra di Gall IT

19



FAIZAN & MUSA
SPECIAL INSTRUMENTS

Elastic



Fig.1

FM- 19-5027-01



Fig.2

FM- 19-5027-02



Fig.3

FM- 19-5027-03



Fig.4

FM- 19-5027-04

Desjardins
30 cm/12"

FM- 19-5027-00
Set of 4

Malleable



FM- 19-5028-02
2.5 mm

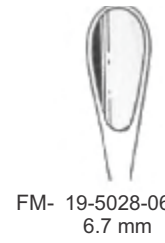

FM- 19-5028-06
6.7 mm



FM- 19-5028-03
3.2 mm



FM- 19-5028-08
8.0 mm

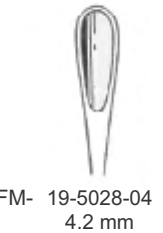

FM- 19-5028-04
4.2 mm



FM- 19-5028-11
11 mm



FM- 19-5028-05
5.5 mm



FM- 19-5028-15
15 mm

Luer-Koerte
32 cm/12½"

FM- 19-5028-00
Set of 8

EN	Gall Stone Scoops
DE	Gallensteinlöffel
ES	Cucharillas para coger cálculos biliares
FR	Scoops de pierre de Gall
IT	Gall Stone Scoops



Mayo
FM- 19-5029-28
28 cm/11"

Malleable



Mayo
26.5 cm/10½"



Fig. 1
FM- 19-5030-01



Fig. 2
FM- 19-5030-02



Fig. 3
FM- 19-5030-03



Moore
FM- 26-8506-28
28 cm/11"

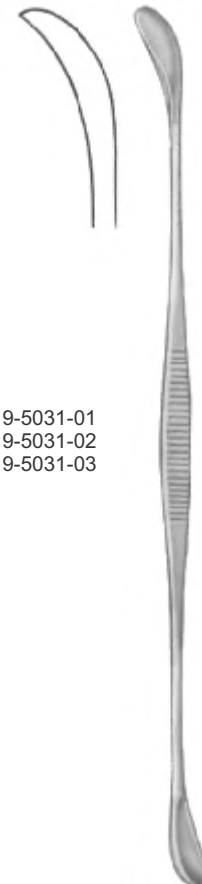
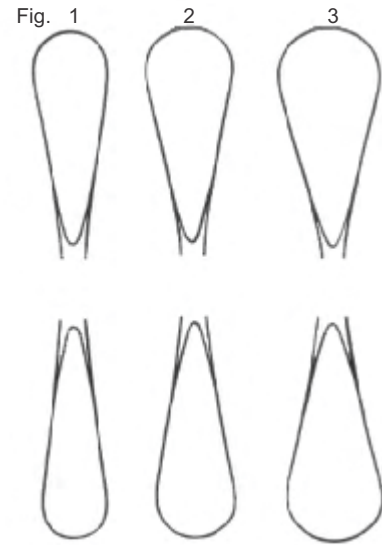

Fergusson
24 cm/9½"

Fig.
1 FM- 19-5031-01
2 FM- 19-5031-02
3 FM- 19-5031-03

Prostatic Retractors, Prostatectomy instruments EN

Postatachaken, Instrumente für prostata-operationen DE

Separadores para la próstata, instrumentos para prostatectomía ES

Rétracteurs prostatiques, instruments de prostatectomie FR

Retrattori prostatici, strumenti di prostatectomia IT

19



FAIZAN & MUSA
SPECIAL INSTRUMENTS

KIDNEY, UROLOGY



Young
FM- 19-5032-22
22 cm/8¾"



Young
FM- 19-5033-21
21 cm/8¼"



Young
FM- 19-5034-22
22 cm/8¾"

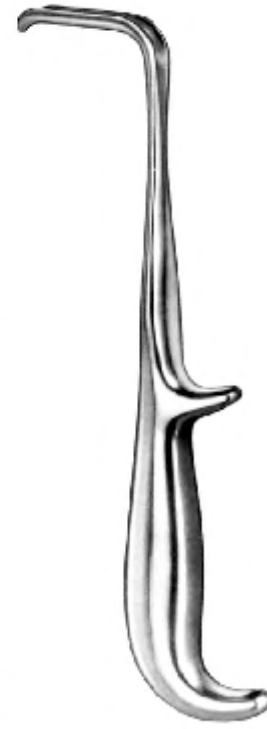

Young
FM- 19-5035-21
21 cm/8¼"



MILLIN
FM- 19-5036-01
24.5cm



FM- 19-5036-02 23.5cm



FM- 19-5036-03 23.0cm



FM- 19-5036-04 23.0cm



FM- 19-5036-05 24.0cm

EN	Bladder Retractors
DE	Gallensteinlöffel
ES	Separadores vesicales
FR	Écarteurs vésicaux
IT	Retrattori della vescica



FAIZAN & MUSA
SPECIAL INSTRUMENTS



Millin
FM- 19-5039-00



Legueu
FM- 19-5040-00

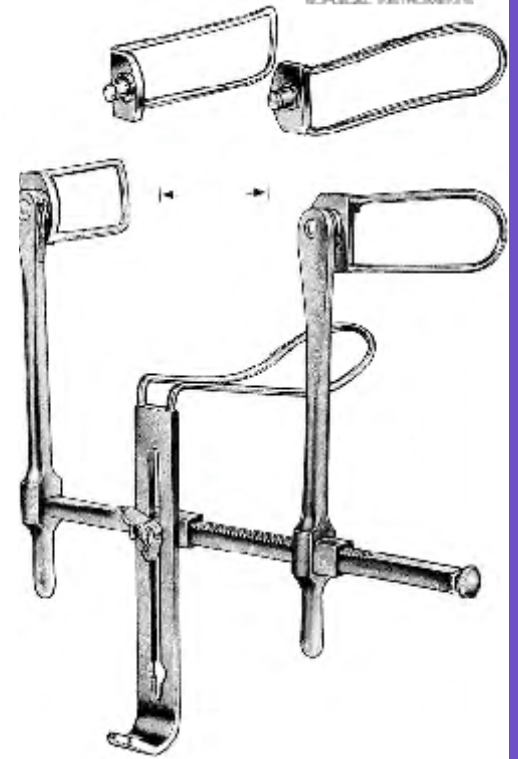

Gosset
FM- 19-5041-00

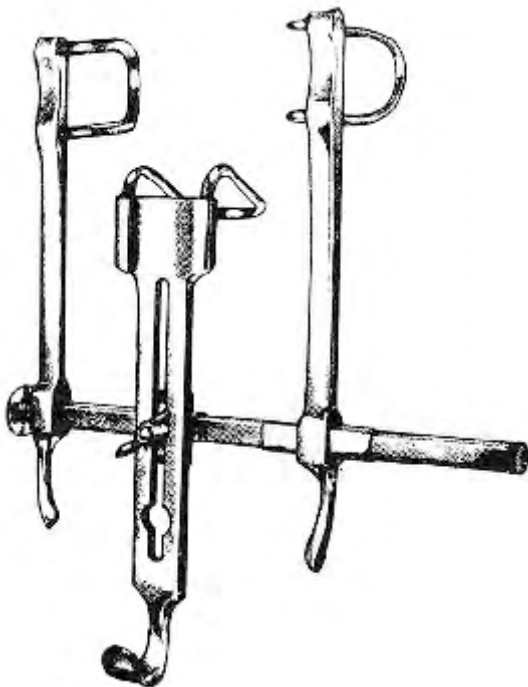

Pantings
FM- 19-5042-00



Millin
FM- 19-5042-01
24 cm/9 1/2"



Millin
FM- 19-5042-02
24 cm/9 1/2"



Millin
FM- 19-5042-03
24 cm/9 1/2"

Bladder Retractors	EN
Blasen-Wundspreizer	DE
Separadores vesicales	ES
Écarteurs vésicaux	FR
Retrattori della vescica	IT

19

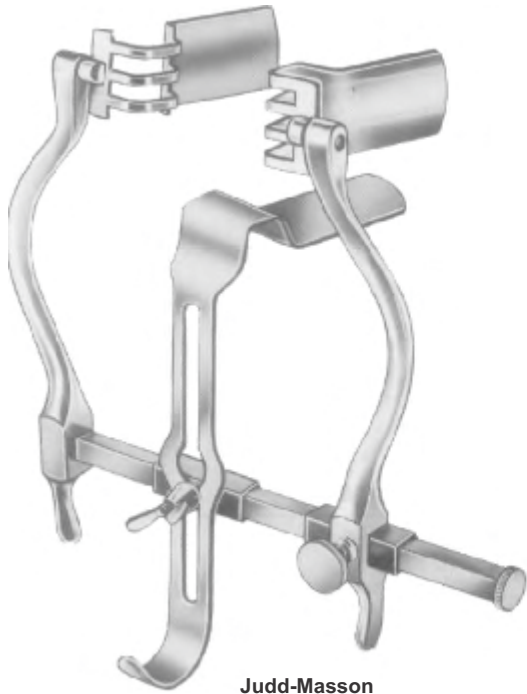

Judd-Masson
FM- 19-5043-00



Thomson-Walker
FM- 19-5044-00



Legueu
FM- 19-5045-27
27 cm/10½"



Kocher
FM- 19-5045-26
26 cm/10¼"



Kocher
FM- 19-5046-26
26 cm/10¼"

EN Foreign Body Forceps

DE Fremdkörperzangen

ES Pinzas p/cuerpos extraños

FR Pincès corporelles étrangères

IT Forza per corpo estraneo

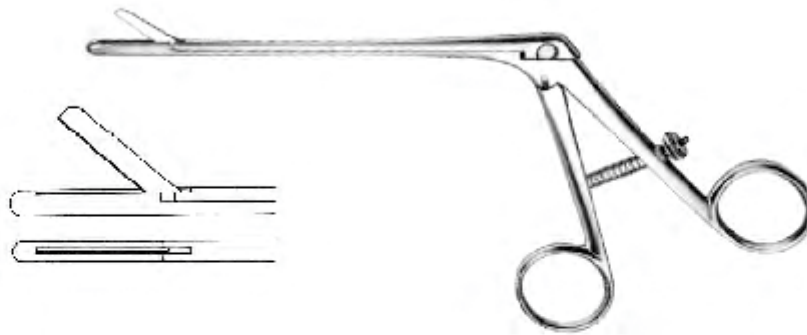

SACHSE
FM- 19-5047-12



MATHIEU
FM- 19-5048-20 20.0cm
FM- 19-5048-28 28.0cm



MATHIEU
FM- 19-5049-20 20.0cm
FM- 19-5049-28 28.0cm

- EN** Retractors
- DE** Wundhaken und -sperrer
- ES** Separadores
- FR** Rétracteurs
- IT** Divaricatori

Page 263 to 300



EN	Retractors
DE	Wundhaken
ES	Separadores
FR	Rétracteurs
IT	Divaricatori

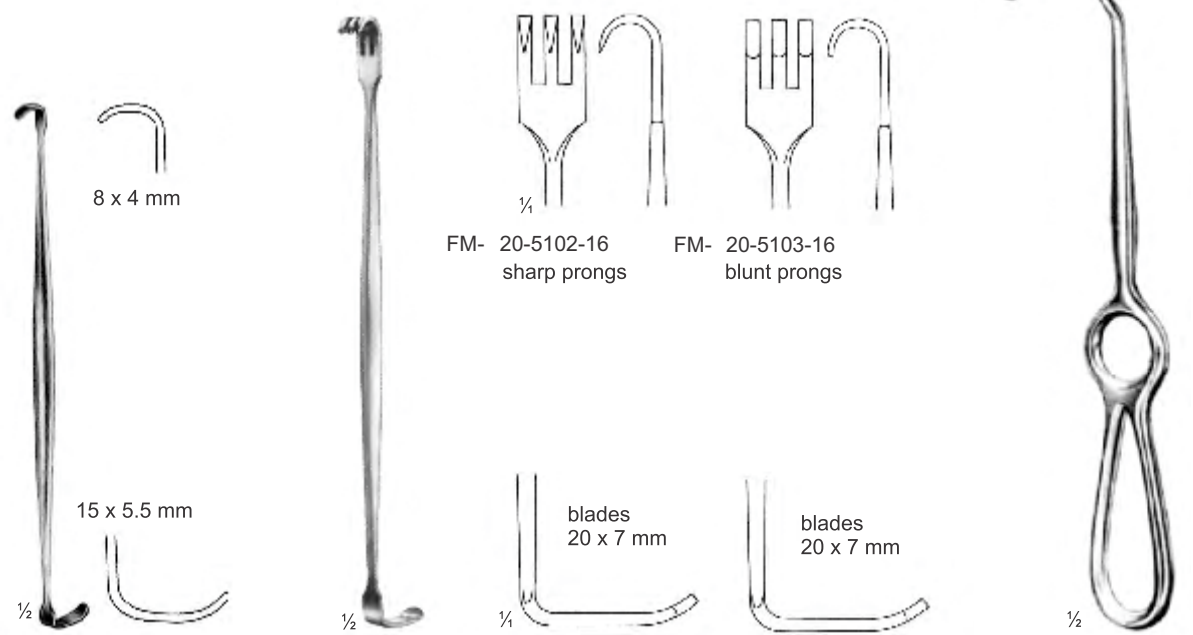

RAGNELL-DAVIS
FM- 20-5101-14
14 cm/5 1/2"

SENN-MILLER
16 cm/6 1/4"

CUSHING
FM- 20-5104-20
20 cm/7 7/8"

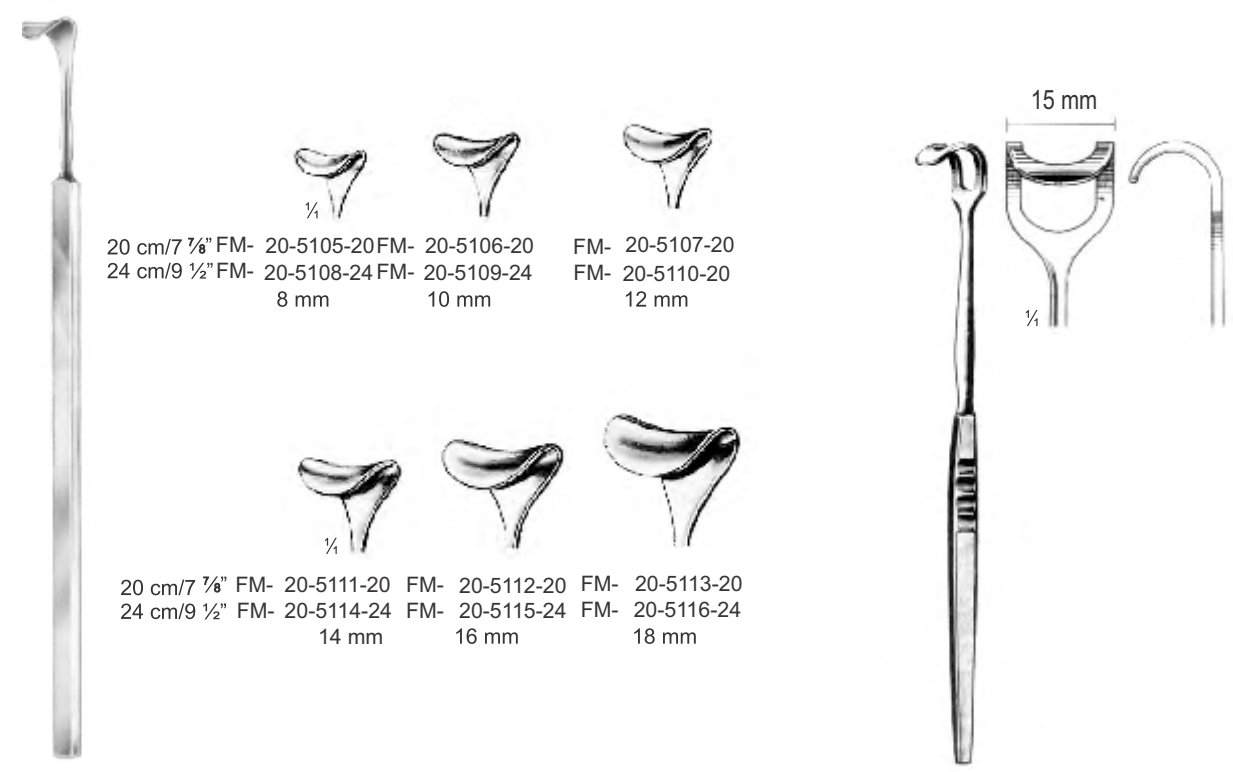

CUSHING

HANDTE
FM- 20-5117-17
17 cm/6 3/4"

- | | | | | |
|-----------------------------|-----------------------------|----------------------|----------------------|----------------------|
| 20 cm/7 7/8" FM- 20-5105-20 | 24 cm/9 1/2" FM- 20-5108-24 | 8 mm FM- 20-5109-24 | 10 mm FM- 20-5106-20 | 12 mm FM- 20-5110-20 |
| 20 cm/7 7/8" FM- 20-5111-20 | 24 cm/9 1/2" FM- 20-5114-24 | 14 mm FM- 20-5115-24 | 16 mm FM- 20-5112-20 | 18 mm FM- 20-5113-20 |

Retractors **EN**
 Wundhaken **DE**
 Separadores **ES**
 Rétracteurs **FR**
 Divaricatori **IT**

20



RETRACTORS

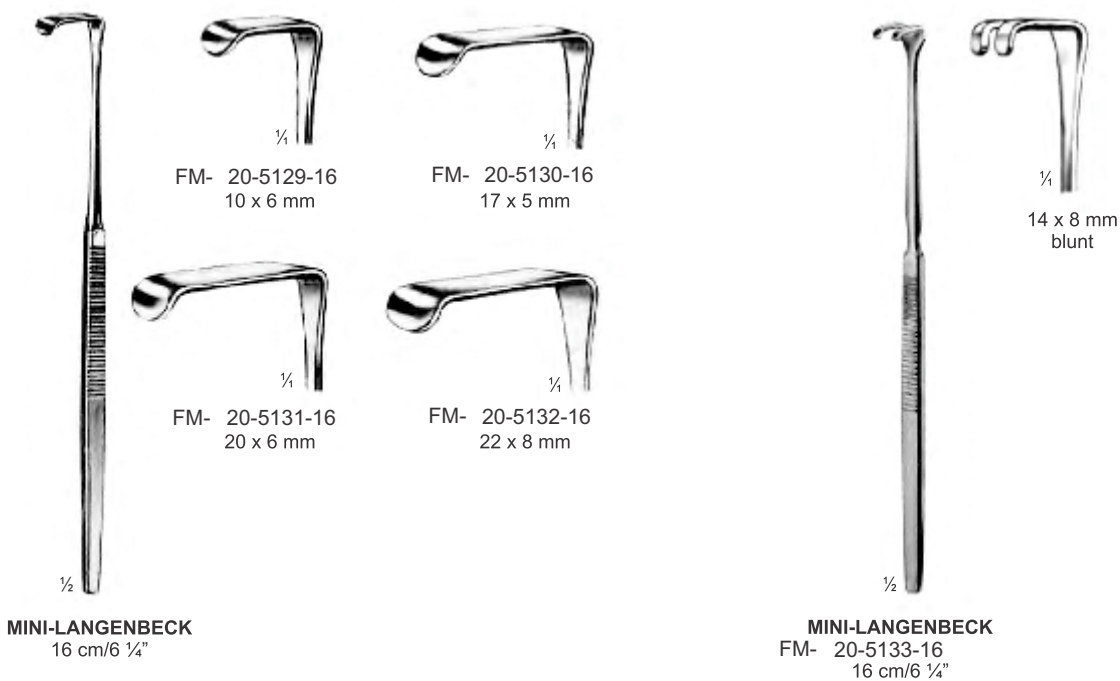
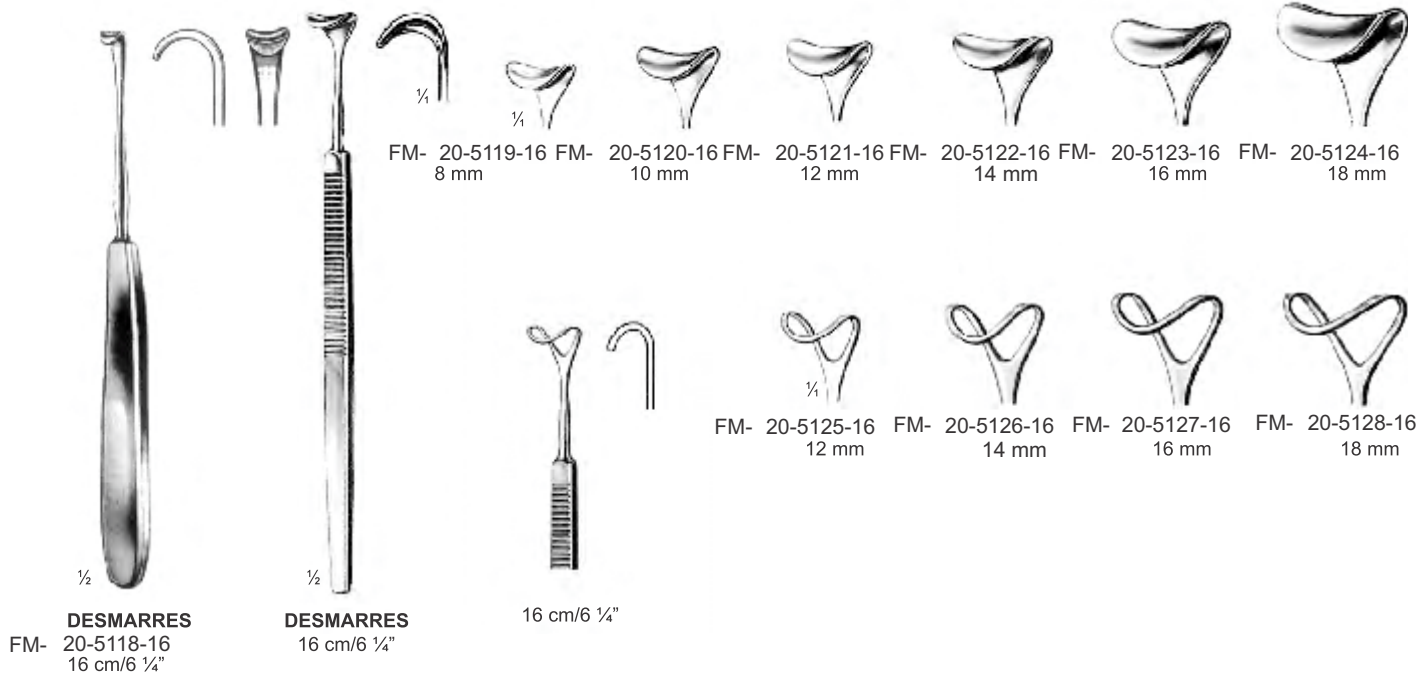

RETRACTORS

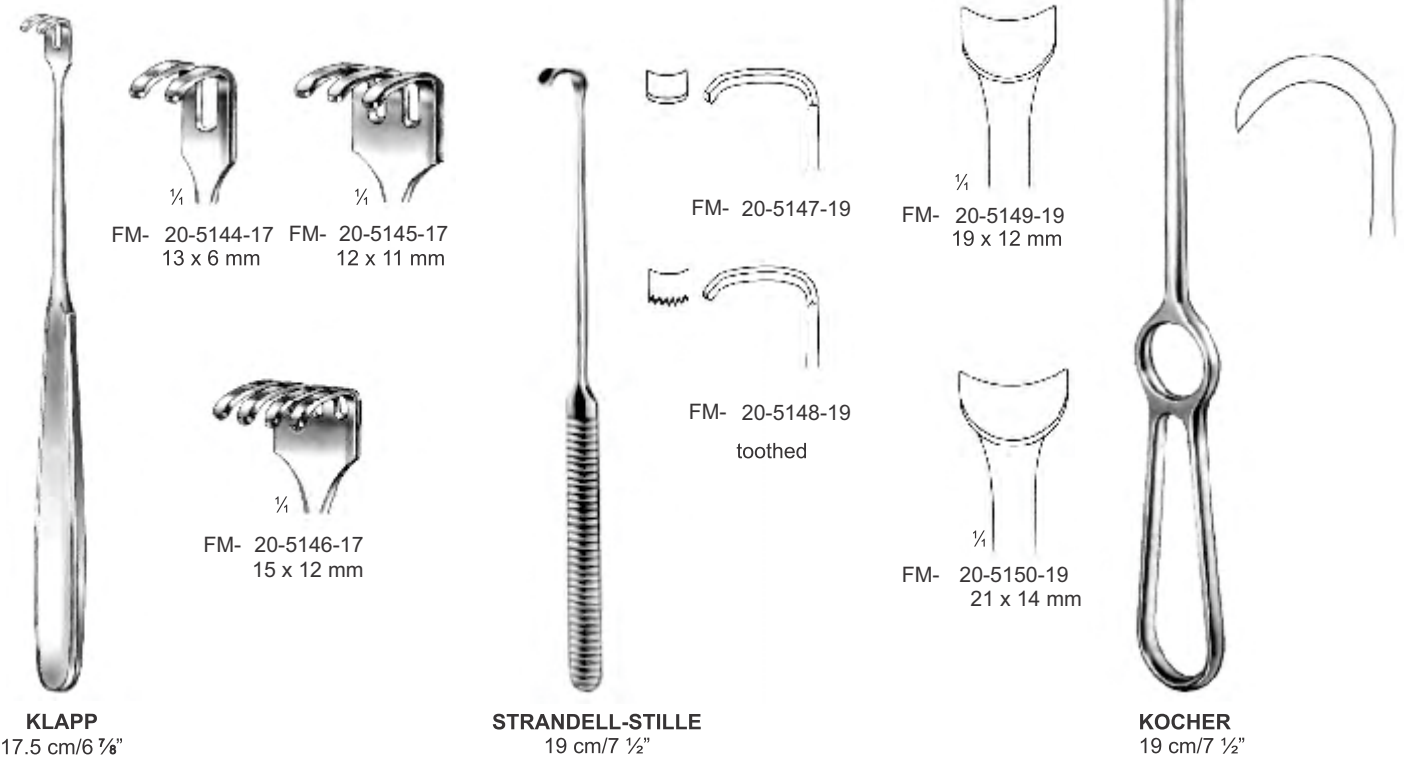
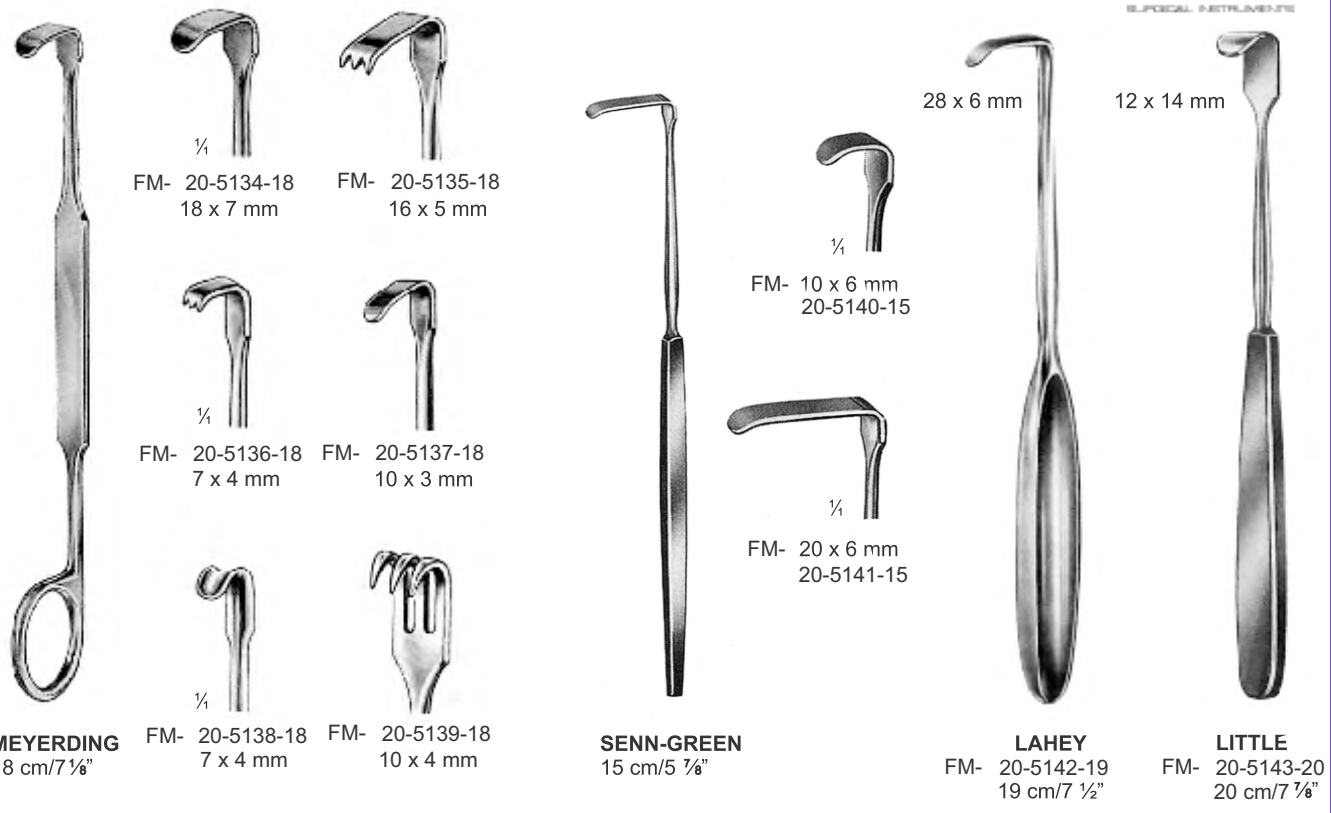

Retractors **EN**
Wundhaken **DE**
Separadores **ES**
Rétracteurs **FR**
Divaricatori **IT**

20



RETRACTORS



KOCHER
23 cm/9"

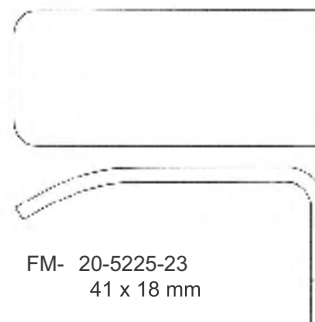

FM- 20-5225-23
41 x 18 mm

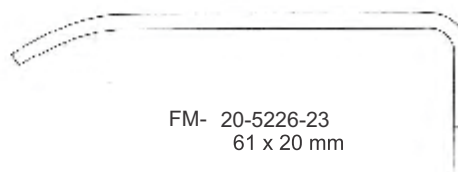

FM- 20-5226-23
61 x 20 mm

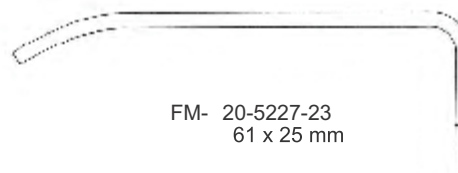

FM- 20-5227-23
61 x 25 mm

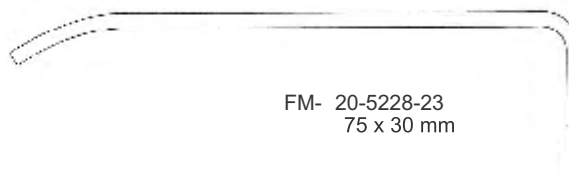

FM- 20-5228-23
75 x 30 mm

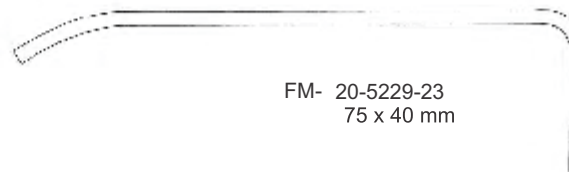

FM- 20-5229-23
75 x 40 mm

¼

EN	Retractors
DE	Wundhaken
ES	Separadores
FR	Rétracteurs
IT	Divaricatori

RETRACTORS

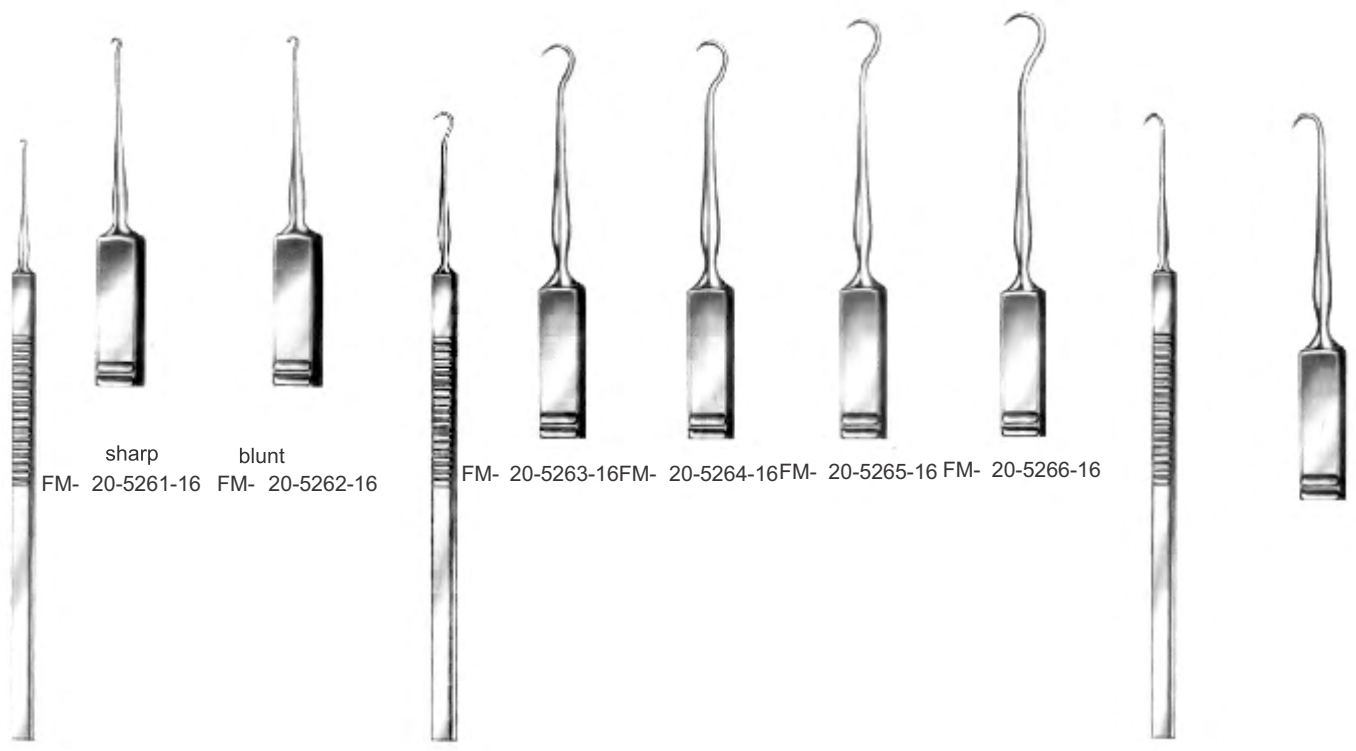

sharp
FM- 20-5261-16

blunt
FM- 20-5262-16

FM- 20-5263-16 FM- 20-5264-16 FM- 20-5265-16 FM- 20-5266-16

GRAEFE
16 cm/6 1/4"

GRAEFE
16 cm/6 1/4"

O'CONNOR
FM- 20-5267-16
16 cm/6 1/4"

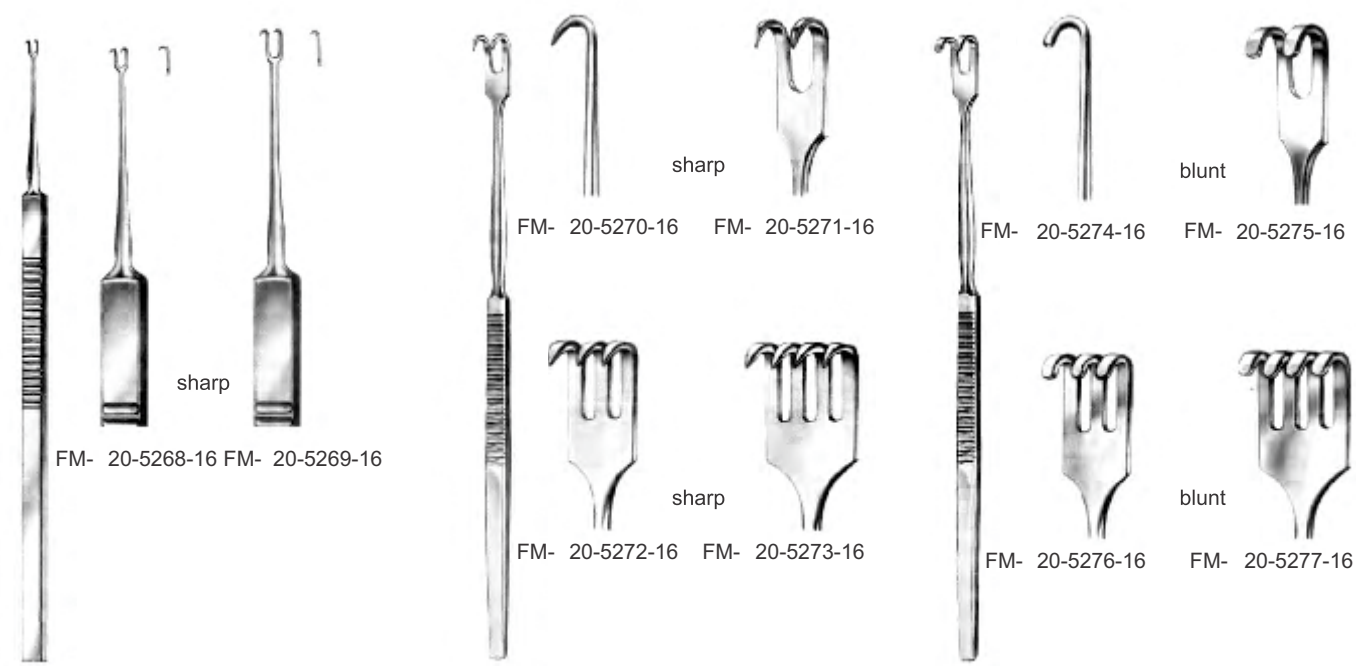

sharp
FM- 20-5268-16 FM- 20-5269-16

sharp
FM- 20-5270-16 FM- 20-5271-16

blunt
FM- 20-5274-16 FM- 20-5275-16

sharp
FM- 20-5272-16 FM- 20-5273-16

blunt
FM- 20-5276-16 FM- 20-5277-16

GUTHRIE
16 cm/6 1/4"

KEHELENGRIFF
16 cm/6 1/4"

KEHELENGRIFF
16 cm/6 1/4"

Measurements of retractors: Depth x Width

Retractors	EN
Wundhaken	DE
Separadores	ES
Rétracteurs	FR
Divaricatori	IT

20



FM- 20-5294-21



FM- 20-5295-21



FM- 20-5296-21



FM- 20-5297-21



FM- 20-5298-21



sharp



FM- 20-5299-21



FM- 20-5300-21



FM- 20-5301-21



FM- 20-5302-21



FM- 20-5303-21



blunt



FM- 20-5304-21



FM- 20-5305-21



FM- 20-5306-21

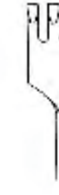

FM- 20-5307-21



FM- 20-5308-21

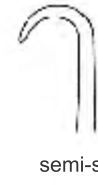

semi-sharp



VOLKMANN
21.5 cm/8 1/2"



FM- 20-5309-21
21.5 cm/8 1/2"



FM- 20-5310-21
21.5 cm/8 1/2"



FM- 20-5311-21 sharp
FM- 20-5312-21 blunt
20 cm/7 7/8"

Measurements of retractors: Depth x Width

EN	Retractors
DE	Wundhaken
ES	Separadores
FR	Rétracteurs
IT	Divaricatori

RETRACTORS



KOCHER
22 cm/8 1/2"

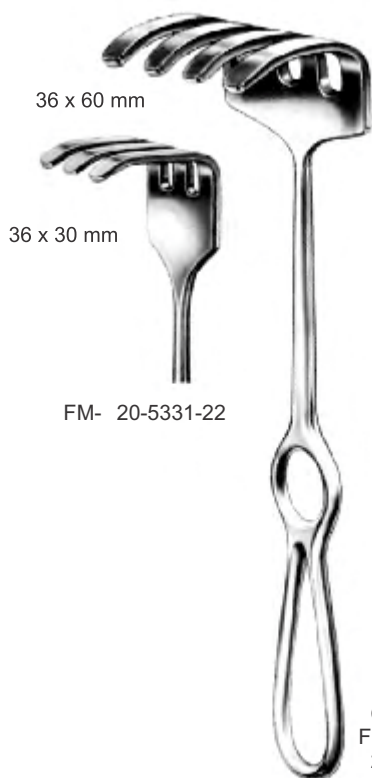

FM- 20-5331-22

OLLIER
FM- 20-5332-22
22.5 cm/8 3/4"



WASSMUND
FM- 20-5333-20
20 cm/7 7/8"

Measurements of retractors: Depth x Width

Retractors	EN
Wundhaken	DE
Separadores	ES
Rétracteurs	FR
Divaricatori	IT

20



RETRACTORS



FM- 20-5334-27
27 cm/10 1/2"



FM- 20-5335-25
40 x 40 mm



FM- 20-5336-25
45 x 50 mm

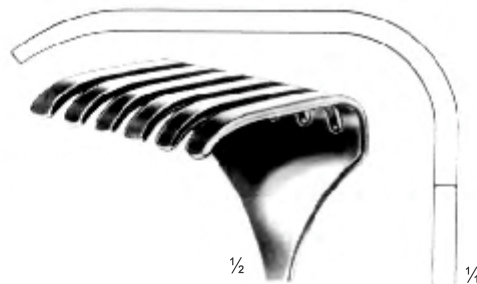

FM- 20-5337-25
50 x 60 mm

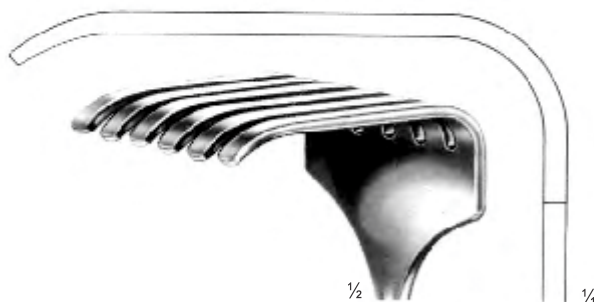

FM- 20-5338-25
70 x 70 mm



ISRAEL
25 cm/9 7/8"

Measurements of retractors: Depth x Width

EN	Retractors
DE	Wundhaken
ES	Separadores
FR	Rétracteurs
IT	Divaricatori



FAIZAN & MUSA
SPECIAL INSTRUMENTS

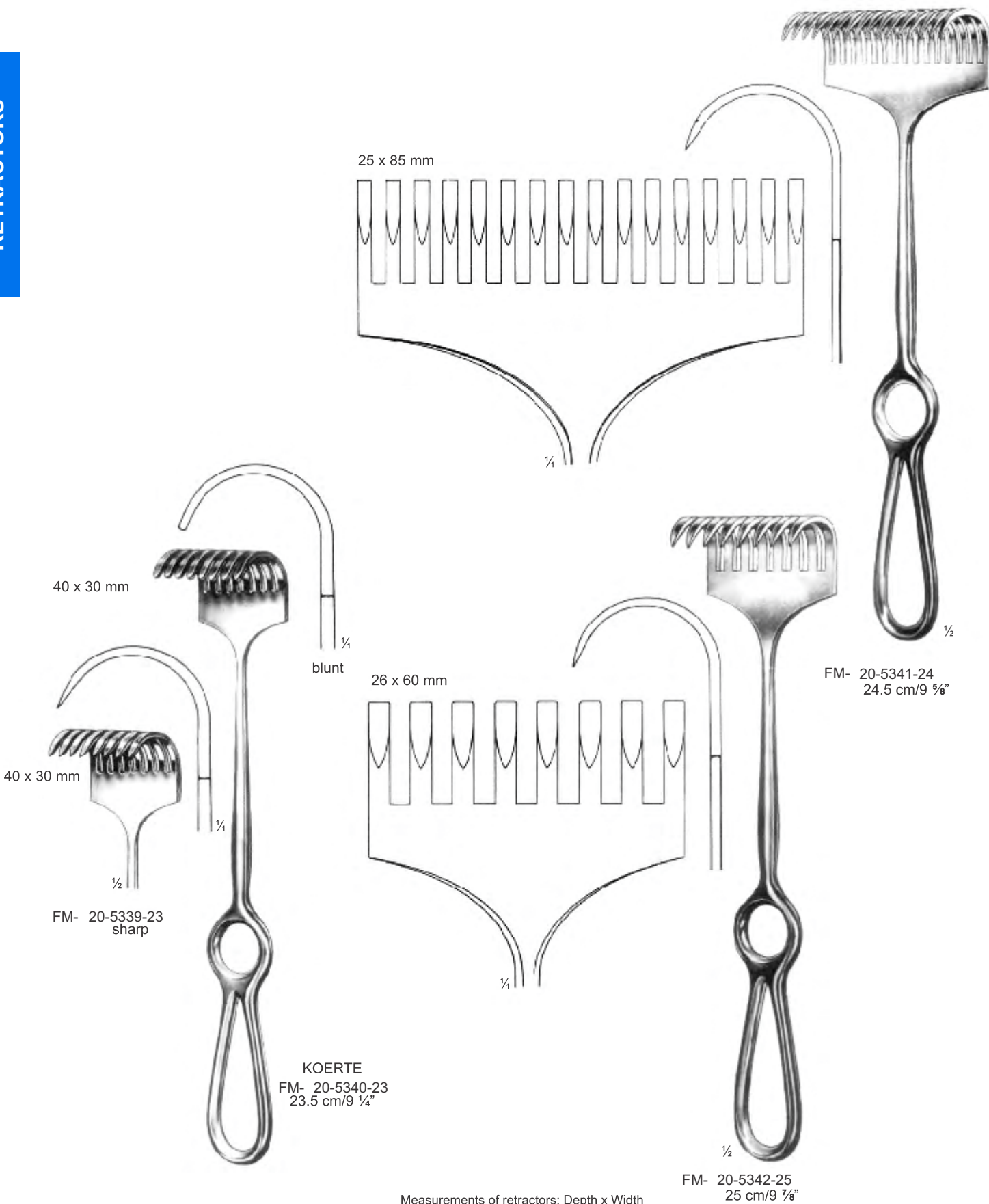

40 x 30 mm

40 x 30 mm

FM- 20-5339-23
sharp

25 x 85 mm

26 x 60 mm

KOERTE
FM- 20-5340-23
23.5 cm/9 1/4"

FM- 20-5341-24
24.5 cm/9 5/8"

FM- 20-5342-25
25 cm/9 7/8"

Measurements of retractors: Depth x Width



Fig. 1
 FM- 20-5343-26
 26 cm/10 1/4"
 25 x 20 mm
 30 x 28 mm



Fig. 2
 FM- 20-5344-27
 27.5 cm/10 3/4"
 43 x 38 mm
 63 x 44 mm

RICHARDSON-EASTMAN

FM- 20-5345-1
 Set Fig. 1 + 2



RICHARDSON

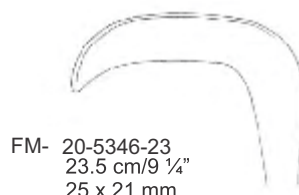

FM- 20-5346-23
 23.5 cm/9 1/4"
 25 x 21 mm

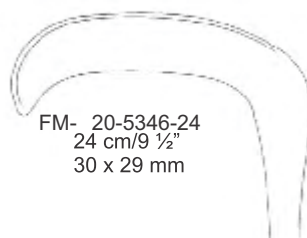

FM- 20-5346-24
 24 cm/9 1/2"
 30 x 29 mm

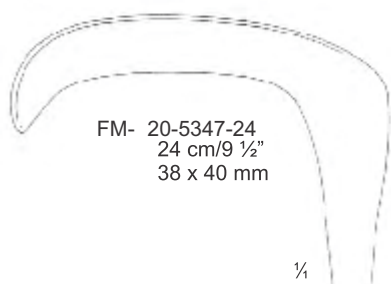

FM- 20-5347-24
 24 cm/9 1/2"
 38 x 40 mm



RICHARDSON

FM- 20-5348-24
 24 cm/9 1/2"

KELLY

FM- 20-5349-26 62 x 50 mm
 FM- 20-5350-26 70 X 65 mm
 26 cm/10 1/4"

EN	Retractors
DE	Wundhaken
ES	Separadores
FR	Rétracteurs
IT	Divaricatori

RETRACTORS

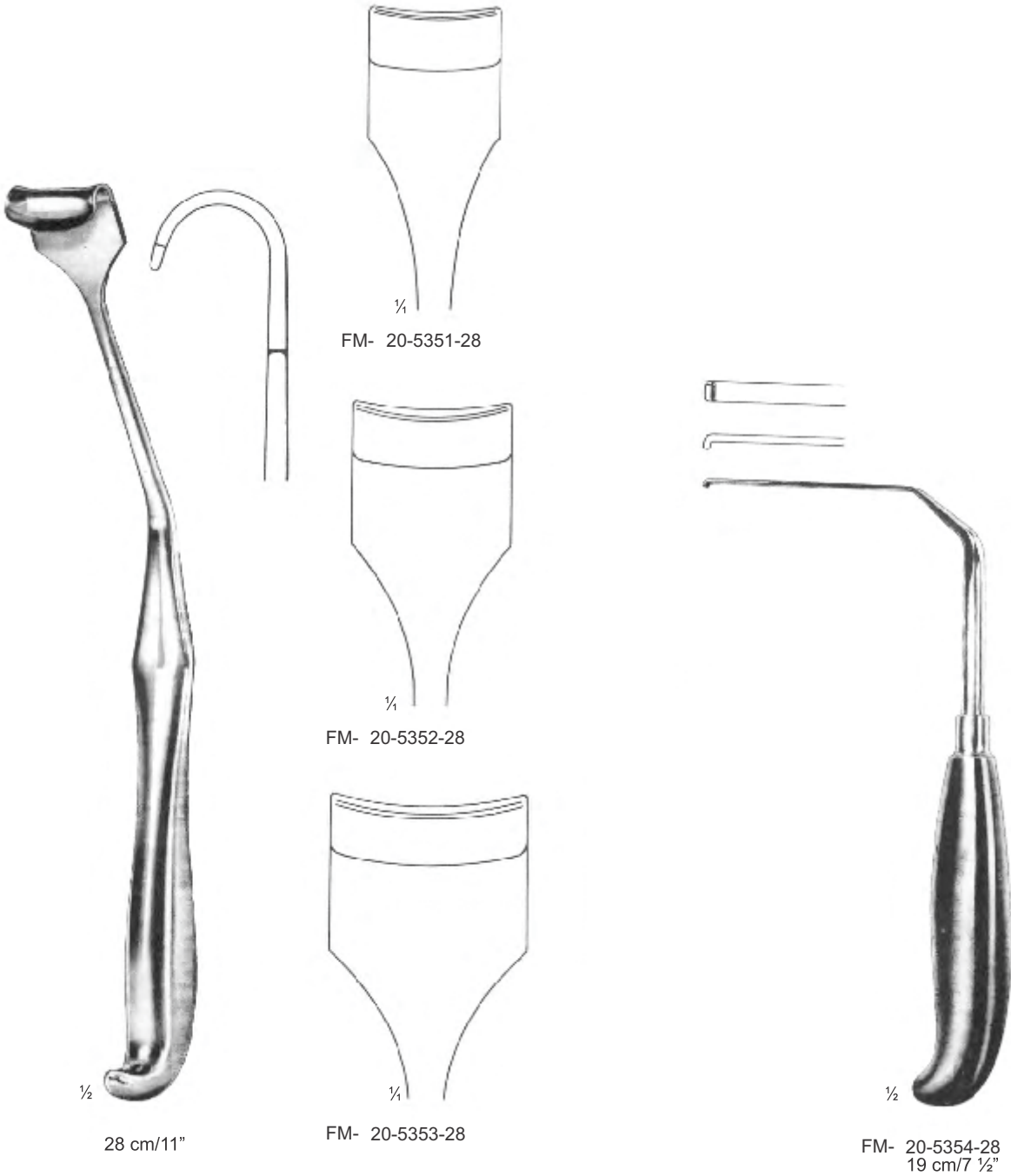

Abdominal Retractors EN

Bauchdeckenhalter DE

Separadores abdominales ES

Rétracteurs abdominaux FR

Divaricatori addominali IT

20



FAIZAN & MUSA
SPECIAL INSTRUMENTS

RETRACTORS



FRITSCH



FM- 20-5372-23
23.5 cm/9 1/4"
37 x 31 mm



FM- 20-5372-24
24 cm/9 1/2"
38 x 40 mm

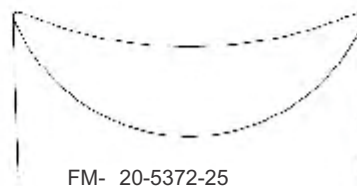

FM- 20-5372-25
25 cm/9 7/8"
43 x 51 mm

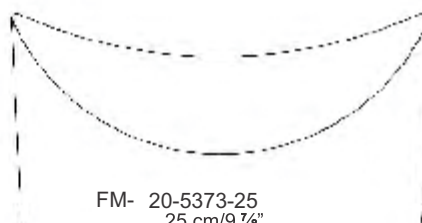

FM- 20-5373-25
25 cm/9 7/8"
49 x 61 mm

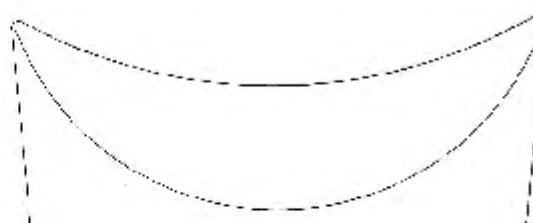

FM- 20-5374-25
25.5 cm/10"
48 x 75 mm



FM- 20-5374-29
29.5 cm/11 3/4"
65 x 85 mm

EN	Retractors, Abdominal Retractors
DE	Wundhaken, Bauchdeckenhalter
ES	Separadores, Separadores abdominales
FR	Écarteurs, rétracteurs abdominaux
IT	Divaricatori, Divaricatori addominali

RETRACTORS

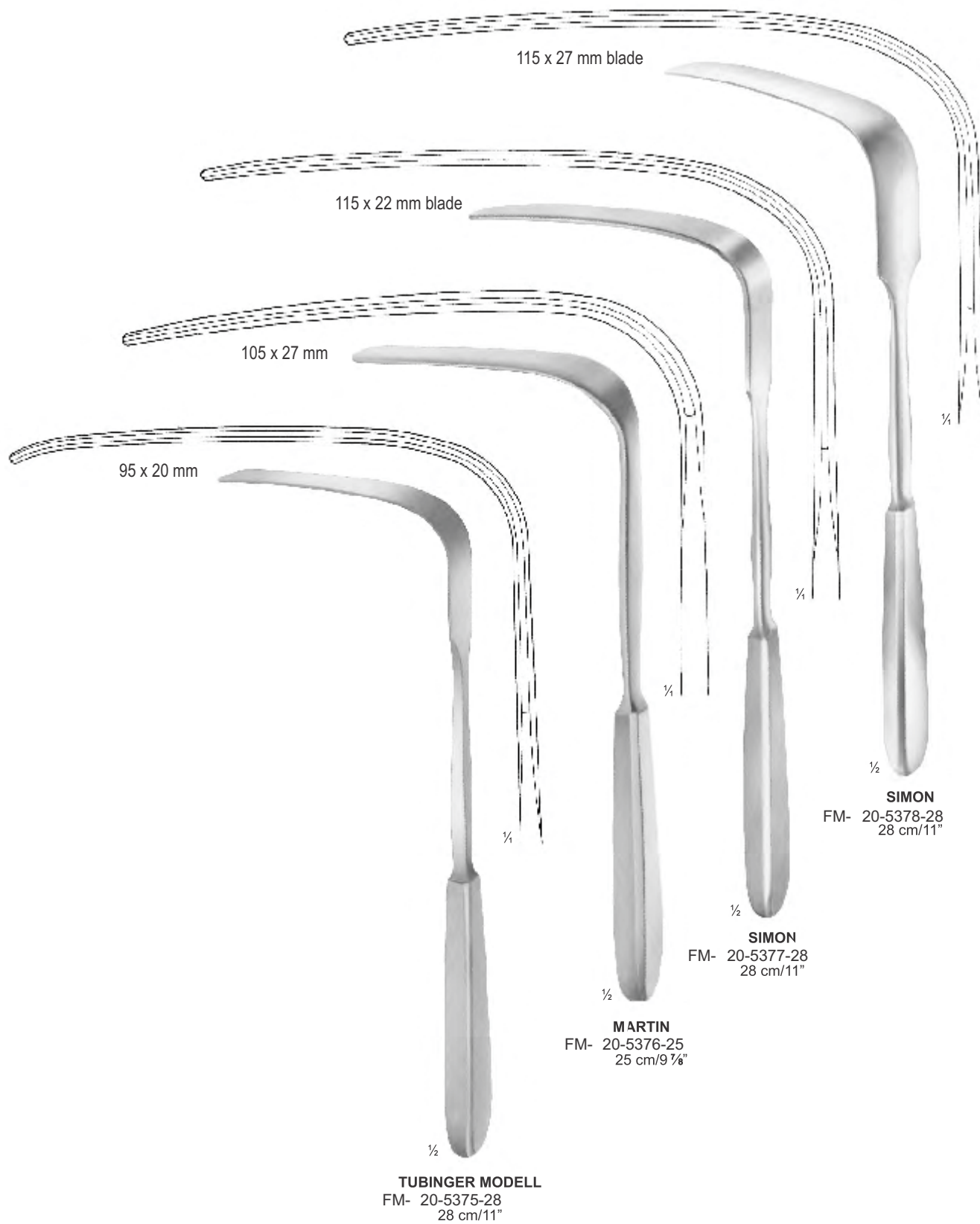

Measurements of retractors: Depth x width

Retractors	EN
Wundhaken	DE
Separadores	ES
Rétracteurs	FR
Divaricatori	IT

20



FAIZAN & MUSA
SPECIAL INSTRUMENTS

RETRACTORS

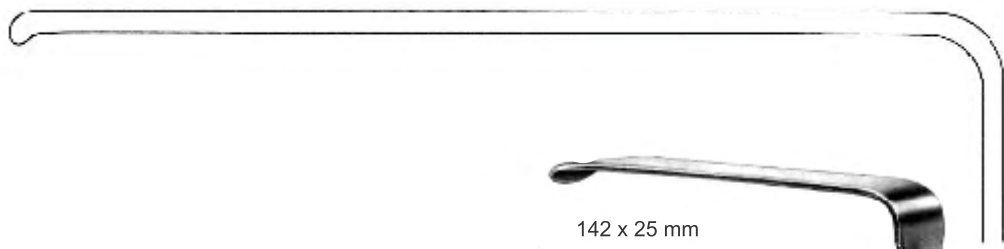

142 x 25 mm



BRUNNER
FM- 20-5382-24
24 cm/9 1/2"

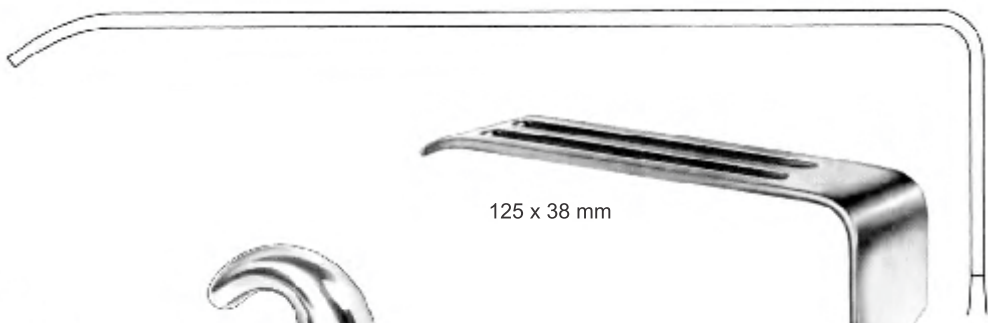

125 x 38 mm

1/2

SAUERBRUCH
FM- 20-5381-25
25.5 cm/10"



DAVIDSON
FM- 20-5379-18
75 x 93 mm
18.5 cm/7 1/4"



FM- 20-5380-19
80 x 54 mm



DAVIDSON
19 cm/7 1/2"
(Scapula)

EN	Retractors
DE	Wundhaken
ES	Separadores
FR	Rétracteurs
IT	Divaricatori



FAIZAN & MUSA
SPECIAL INSTRUMENTS

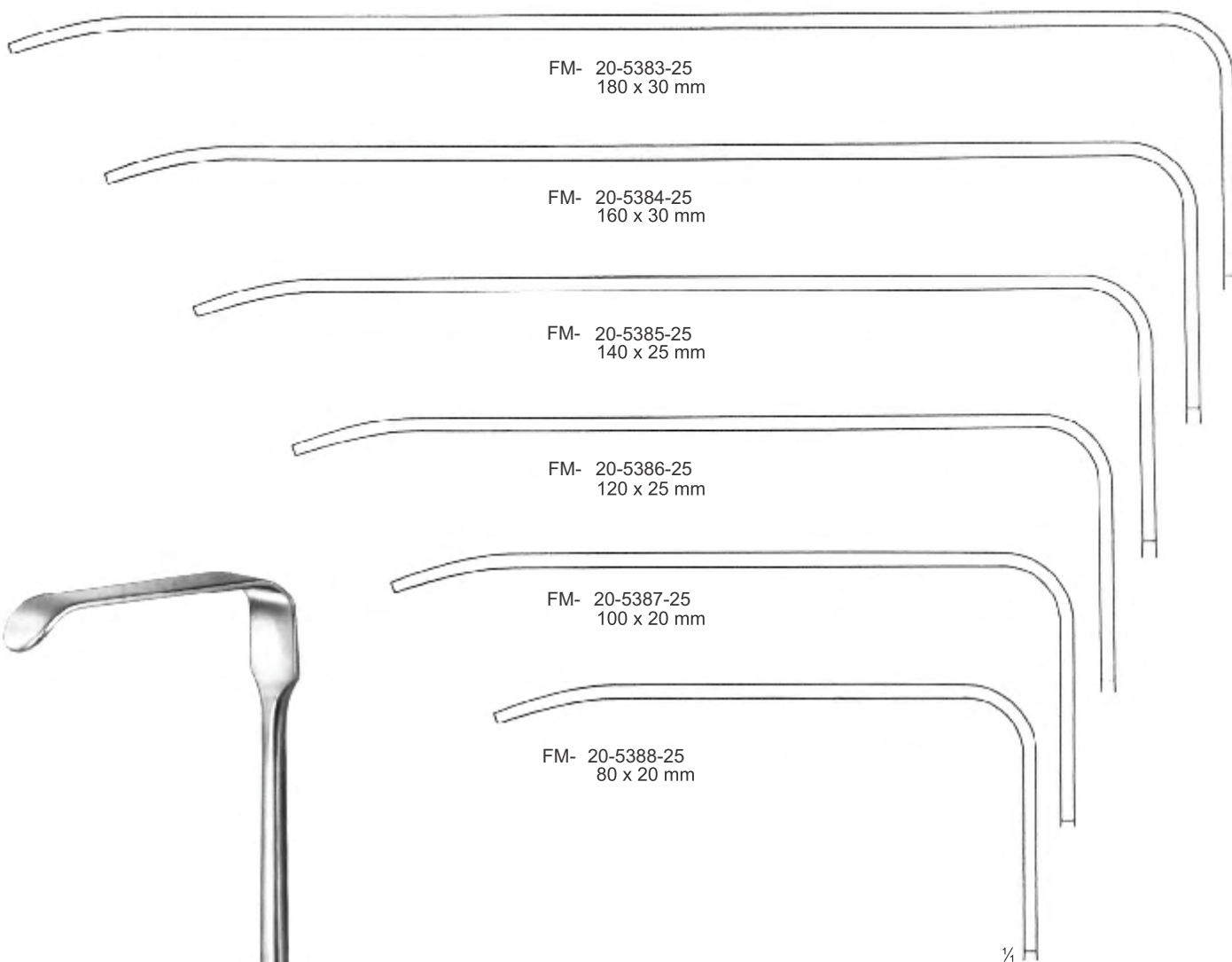

BRUNNER
25 cm/9 7/8"

Retractors EN
 Wundhaken DE
 Separadores ES
 Rétracteurs FR
 Divaricatori IT

20



RETRACTORS



DEAVER
 FM- 20-5405-18
 18 cm/7 1/8"

DEAVER
 FM- 20-5406-21
 21.5 cm/8 1/2"

DEAVER
 FM- 20-5407-21
 21.5 cm/8 1/2"

DEAVER
 FM- 20-5408-30
 30.5 cm/12"

DEAVER
 FM- 20-5409-33
 33.5 cm/13 1/4"

DEAVER
 FM- 20-5410-34
 34.5 cm/13 5/8"

EN	Retractors
DE	Wundhaken
ES	Separadores
FR	Rétracteurs
IT	Divaricatori

RETRACTORS

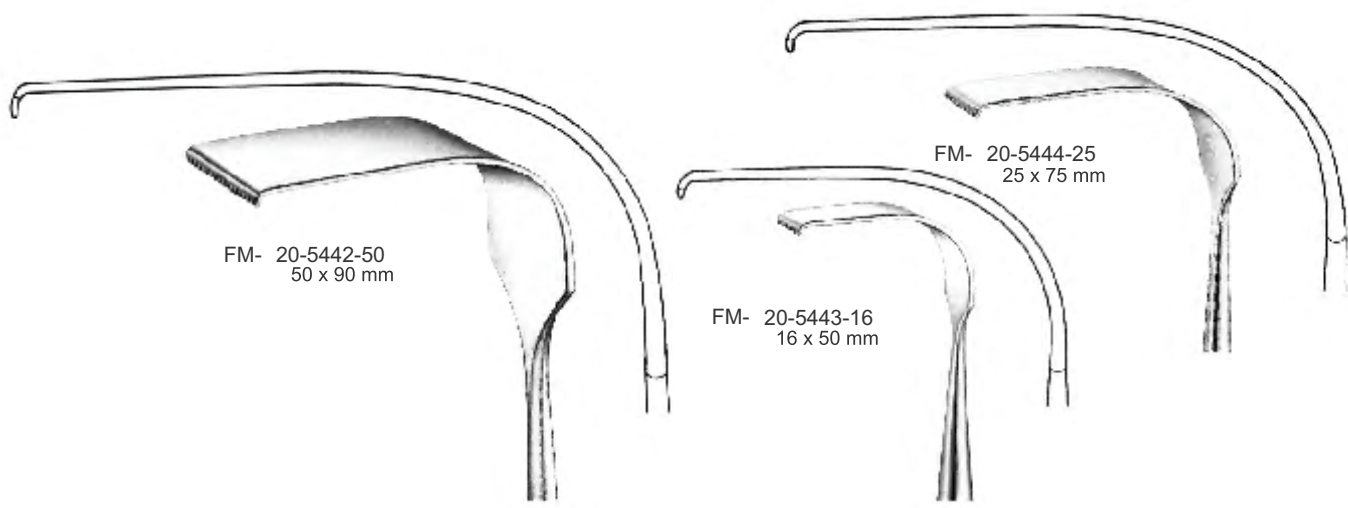

FM- 20-5442-50
50 x 90 mm

FM- 20-5444-25
25 x 75 mm

FM- 20-5443-16
16 x 50 mm

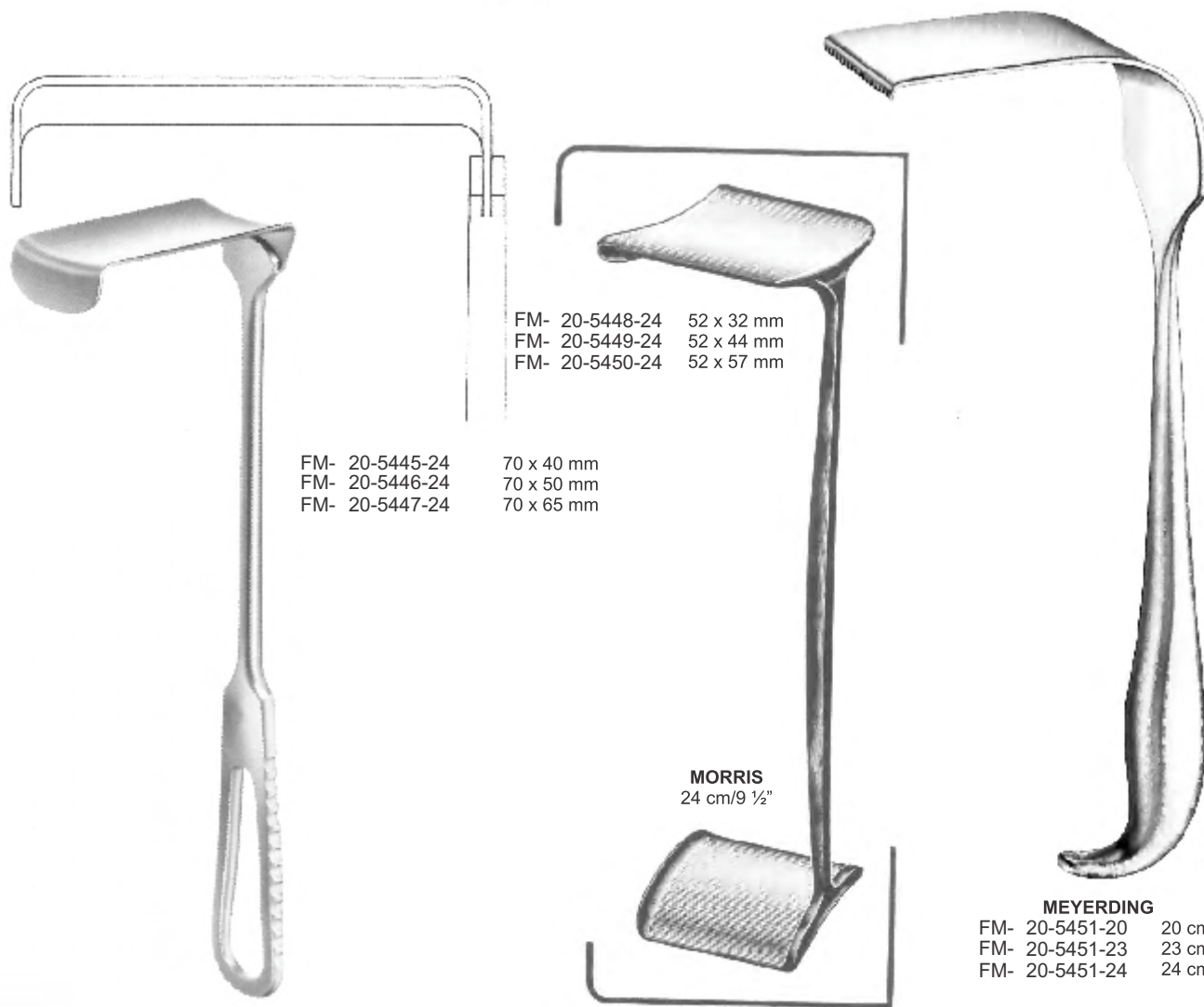

FM- 20-5445-24 70 x 40 mm
FM- 20-5446-24 70 x 50 mm
FM- 20-5447-24 70 x 65 mm

FM- 20-5448-24 52 x 32 mm
FM- 20-5449-24 52 x 44 mm
FM- 20-5450-24 52 x 57 mm

MORRIS
24 cm/9 1/2"

MORRIS
24.5 cm/9 5/8"

MEYERDING
FM- 20-5451-20 20 cm/7 7/8"
FM- 20-5451-23 23 cm/9"
FM- 20-5451-24 24 cm/9 1/2"

Measurements of Spatulas : Depth x Width

30 x 21 mm
38 x 30 mm

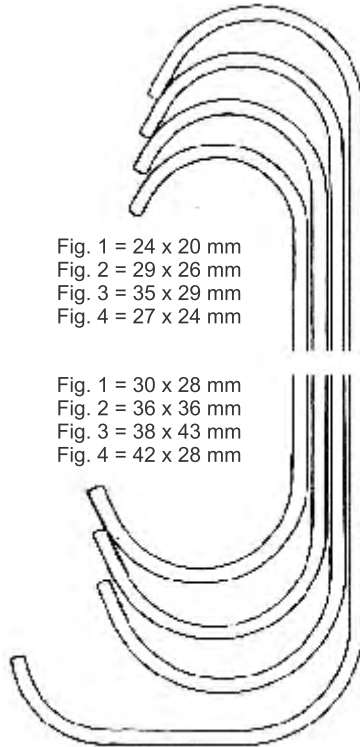
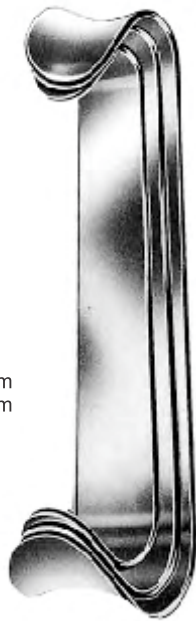

Fig. 1 = 24 x 20 mm
Fig. 2 = 29 x 26 mm
Fig. 3 = 35 x 29 mm
Fig. 4 = 27 x 24 mm

Fig. 1 = 30 x 28 mm
Fig. 2 = 36 x 36 mm
Fig. 3 = 38 x 43 mm
Fig. 4 = 42 x 28 mm

Fig. 1 = 24 x 20 mm
Fig. 2 = 29 x 26 mm
Fig. 3 = 35 x 39 mm
Fig. 4 = 27 x 24 mm

Fig. 1 = 30 x 28 mm
Fig. 2 = 36 x 36 mm
Fig. 3 = 38 x 43 mm
Fig. 4 = 42 x 28 mm

ROUX

- FM- 20-5452-01 Set Fig. 1 - 3
- FM- 20-5452-14 Fig. 1 14 cm/5 1/2"
- FM- 20-5452-15 Fig. 2 15 cm/5 7/8"
- FM- 20-5452-17 Fig. 3 17 cm/6 3/4"
- FM- 20-5452-18 Fig. 4 18 cm/7 1/8"

ROUX-MAGNUS

- FM- 20-5453-01 Set Fig. 1 - 3
- FM- 20-5453-14 Fig. 1 14 cm/5 1/2"
- FM- 20-5453-15 Fig. 2 15 cm/5 7/8"
- FM- 20-5453-17 Fig. 3 17 cm/6 3/4"
- FM- 20-5453-18 Fig. 4 18 cm/7 1/8"

Fig. 2 = 30 x 10 mm
Fig. 1 = 26 x 10 mm

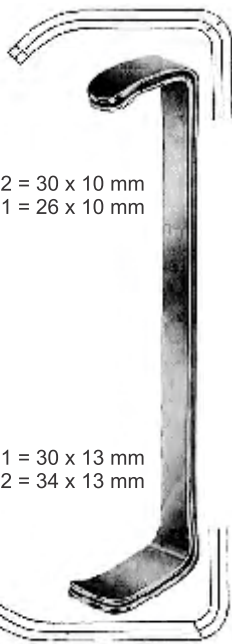

Fig. 2 = 27 x 16 mm
Fig. 1 = 23 x 16 mm



Fig. 1 = 26 x 16 mm
Fig. 2 = 30 x 16 mm

Fig. 1 = 30 x 13 mm
Fig. 2 = 34 x 13 mm

FARABEUFF

- FM- 20-5454-11 Set
- FM- 20-5455-11 Fig. 1
- FM- 20-5456-11 Fig. 2
- 11.5 cm/4 1/2"

FARABEUFF

- FM- 20-5457-15 Set
- FM- 20-5458-15 Fig. 1
- FM- 20-5459-15 Fig. 2
- 15 cm/5 7/8"

18 x 17 mm

6 X 7 mm
7 X 8 mm



24 x 21 mm

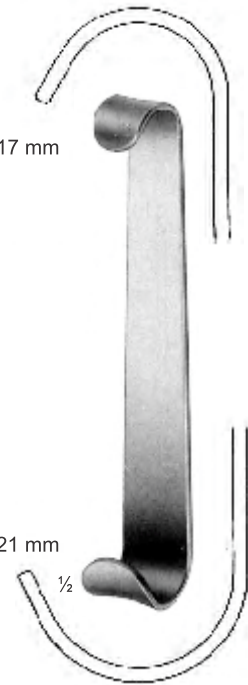

- MINI-ROUX**
- FM- 20-5460-14
- 14 cm/5 1/2"

- BABY ROUX**
- FM- 20-5461-13
- 13 cm/5 1/8"



Fig. 2 = 22 x 15 mm
Fig. 1 = 19 x 15 mm

Fig. 1 = 19 x 15 mm
Fig. 2 = 22 x 15 mm

PARKER

- | | |
|----------------|--------|
| FM- 20-5462-13 | Set |
| FM- 20-5463-13 | Fig. 1 |
| FM- 20-5464-13 | Fig. 2 |
| 13.5 cm/5 3/8" | |

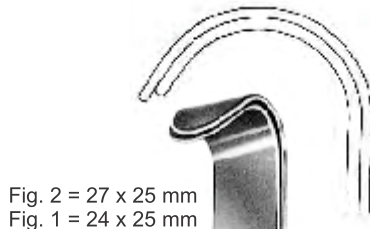

Fig. 2 = 27 x 25 mm
Fig. 1 = 24 x 25 mm

Fig. 1 = 26 x 25 mm
Fig. 2 = 29 x 25 mm

PARKER

- | | |
|----------------|--------|
| FM- 20-5465-18 | Set |
| FM- 20-5466-18 | Fig. 1 |
| FM- 20-5467-18 | Fig. 2 |
| 18 cm/7 1/8" | |

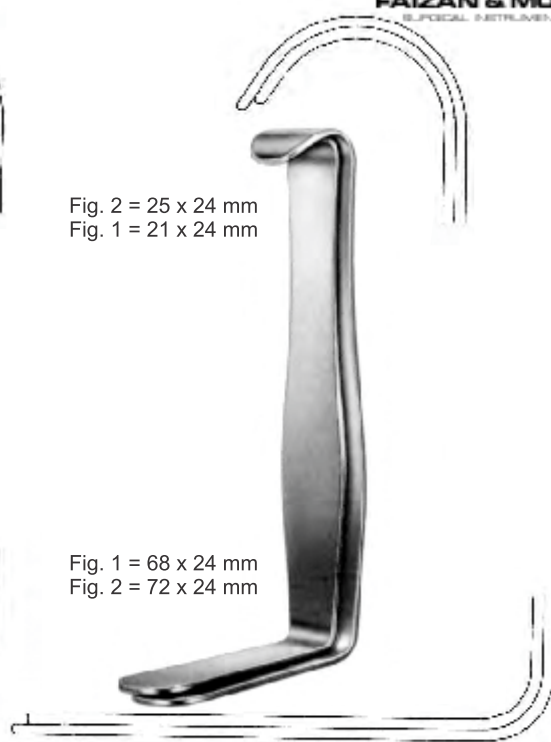

Fig. 2 = 25 x 24 mm
Fig. 1 = 21 x 24 mm

Fig. 1 = 68 x 24 mm
Fig. 2 = 72 x 24 mm

PARKER-MOTT

- | | |
|----------------|--------|
| FM- 20-5468-16 | Set |
| FM- 20-5469-16 | Fig. 1 |
| FM- 20-5470-16 | Fig. 2 |
| 16 cm/6 1/4" | |

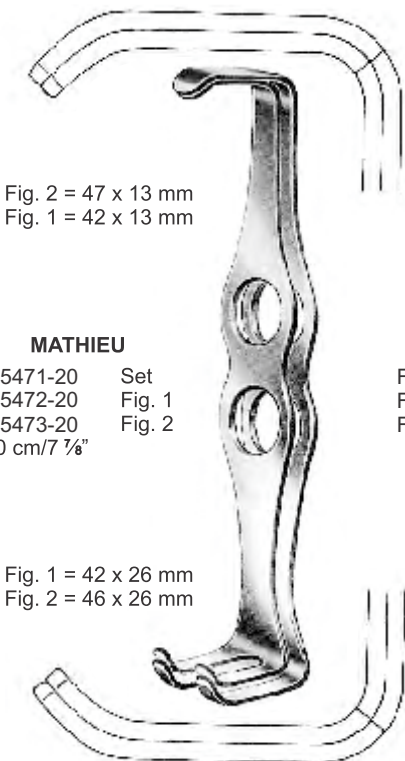

Fig. 2 = 47 x 13 mm
Fig. 1 = 42 x 13 mm

MATHIEU

- | | |
|----------------|--------|
| FM- 20-5471-20 | Set |
| FM- 20-5472-20 | Fig. 1 |
| FM- 20-5473-20 | Fig. 2 |
| 20 cm/7 7/8" | |

Fig. 1 = 42 x 26 mm
Fig. 2 = 46 x 26 mm

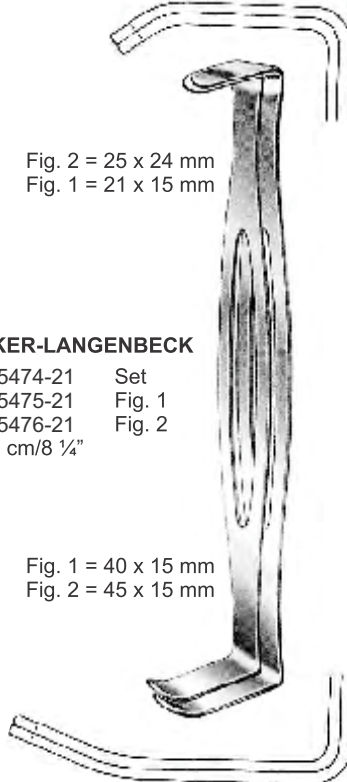
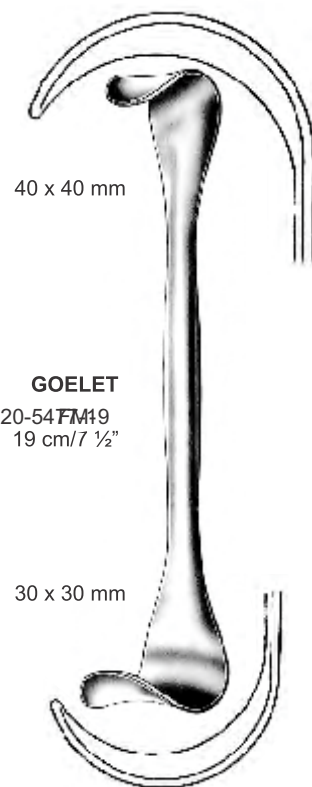

Fig. 2 = 25 x 24 mm
Fig. 1 = 21 x 15 mm

PARKER-LANGENBECK

- | | |
|----------------|--------|
| FM- 20-5474-21 | Set |
| FM- 20-5475-21 | Fig. 1 |
| FM- 20-5476-21 | Fig. 2 |
| 21 cm/8 1/4" | |

Fig. 1 = 40 x 15 mm
Fig. 2 = 45 x 15 mm



40 x 40 mm

GOELET

- | | |
|----------------|--------|
| 20-5477-19 | Set |
| FM- 20-5478-19 | Fig. 1 |
| 19 cm/7 1/2" | |

30 x 30 mm

Retractors	EN
Wundhaken	DE
Separadores	ES
Rétracteurs	FR
Divaricatori	IT



1/2

CRILE

FM- 20-5478-11
11 cm/4 3/8"

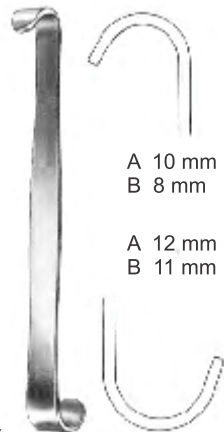

1/2

LUER

FM- 20-5479-11
11 cm/4 3/8"

A 10 mm
B 8 mm

A 12 mm
B 11 mm

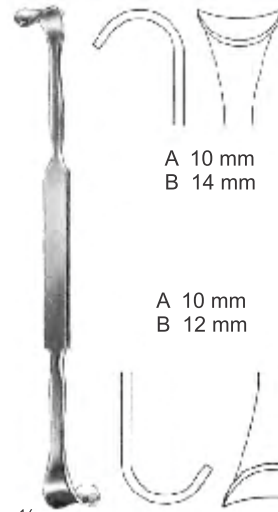

1/2

ROSE

FM- 20-5480-13
13 cm/5 1/8"

A 10 mm
B 14 mm

A 10 mm
B 12 mm



1/2

ROSE

FM- 20-5481-19
19.5 cm/7 1/2"

A 14 mm
B 14 mm

A 12 mm
B 12 mm



MAYO-COLLINS

FM- 20-5482-15
15 cm/5 7/8"

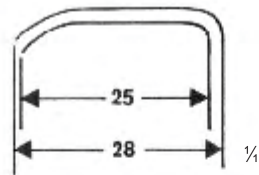

28 x 18 mm
25 x 18 mm

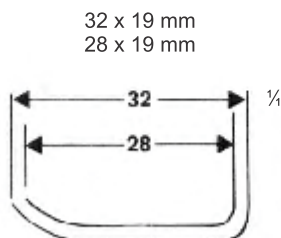

32 x 19 mm
28 x 19 mm



COLLIN

FM- 20-5483-14
14.5 cm/5 3/4"

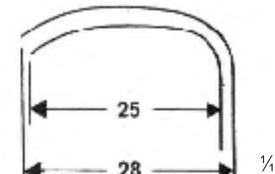

28 x 14 mm
25 x 14 mm

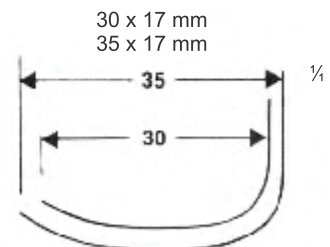

30 x 17 mm
35 x 17 mm

EN Self-Retaining Retractors
 DE Wundspreizer
 ES Separadores autoestáticos
 FR Rétracteurs auto-bloquants
 IT Retrattori auto-bloccanti



RETRACTORS

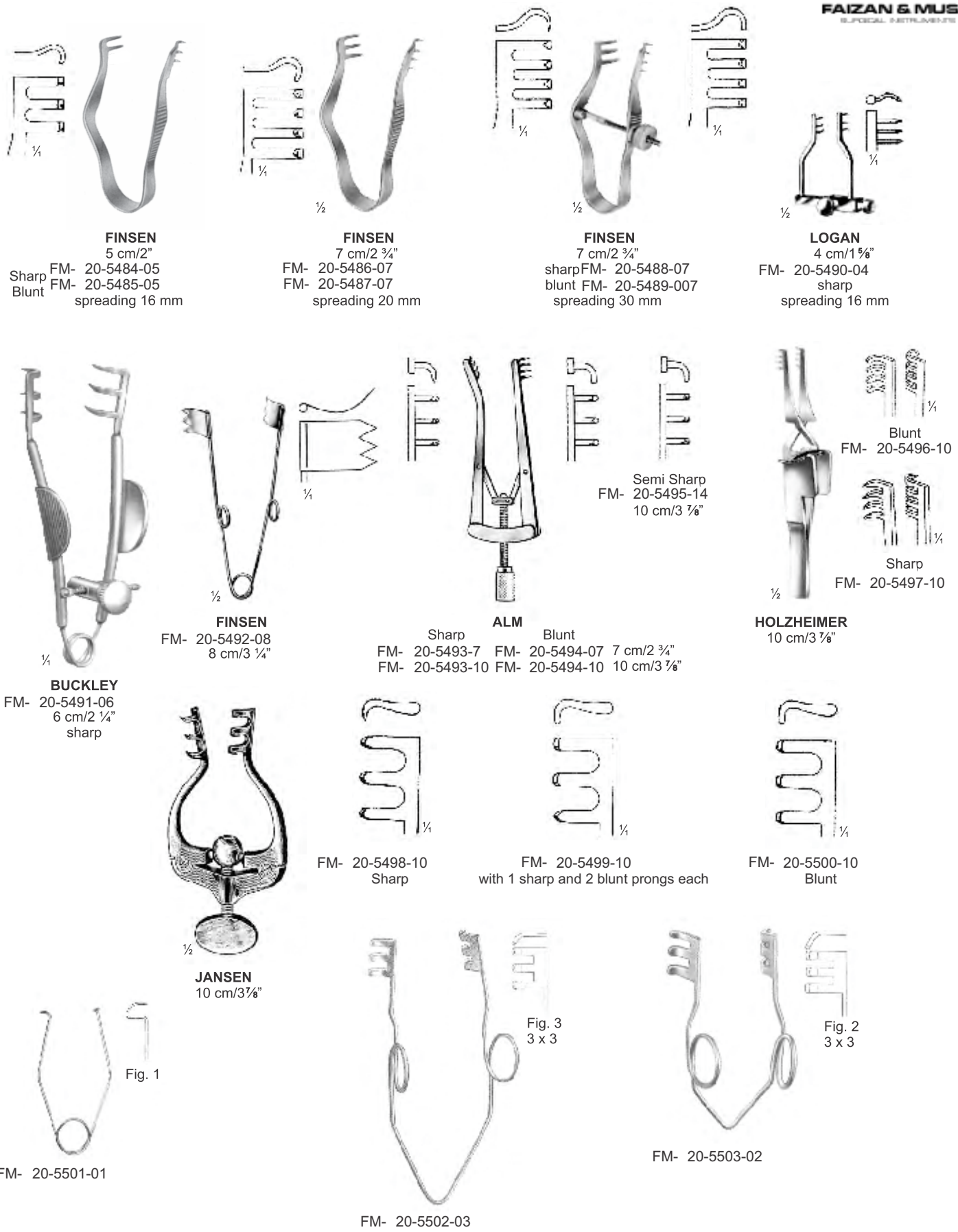

FINSEN

5 cm/2"

FM- 20-5484-05

Sharp FM- 20-5485-05

Blunt spreading 16 mm

FINSEN

7 cm/2 3/4"

FM- 20-5486-07

FM- 20-5487-07

spreading 20 mm

FINSEN

7 cm/2 3/4"

sharp FM- 20-5488-07

blunt FM- 20-5489-007

spreading 30 mm

LOGAN

4 cm/1 5/8"

FM- 20-5490-04

sharp

spreading 16 mm

BUCKLEY

FM- 20-5491-06

6 cm/2 1/4"

sharp

FINSEN

FM- 20-5492-08

8 cm/3 1/4"

ALM

Sharp FM- 20-5493-7

FM- 20-5493-10

ALM

Blunt FM- 20-5494-07

FM- 20-5494-10

Semi Sharp

FM- 20-5495-14

10 cm/3 1/8"

HOLZHEIMER

10 cm/3 1/8"

Sharp

FM- 20-5497-10

Blunt

FM- 20-5496-10

FM- 20-5498-10

Sharp

FM- 20-5499-10

with 1 sharp and 2 blunt prongs each

FM- 20-5500-10

Blunt

JANSEN

10 cm/3 7/8"

Fig. 3

3 x 3

Fig. 2

3 x 3

FM- 20-5501-01

FM- 20-5503-02

FM- 20-5502-03



WEITLANER
2 : 2

FM- 20-5504-13 sharp
FM- 20-5505-13 blunt
13.5 cm/5 3/8"



WEITLANER
2 : 2

FM- 20-5506-13 semi sharp
13.5 cm/5 3/8"

1/2



WEITLANER
2 : 3

FM- 20-5507-10 sharp
FM- 20-5508-10 blunt
10.5 cm/4 1/8"



WEITLANER
3 : 4

FM- 20-5509-13 13 cm/5 1/8" sharp
FM- 20-5510-13 13 cm/5 1/8" blunt
FM- 20-5511-16 16.5 cm/6 1/2" sharp
FM- 20-5412-16 16.5 cm/6 1/2" blunt

1/2

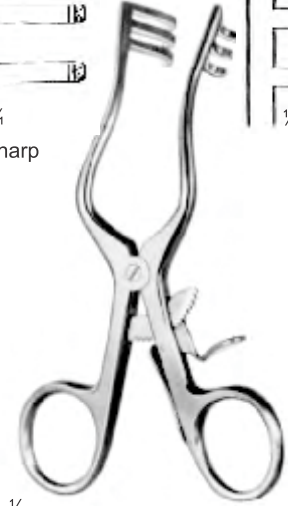

WEITLANER-WULLSTEIN
3 : 3

FM- 20-5513-13 sharp
FM- 20-5514-13 blunt
13 cm/5 1/8"

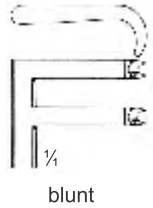
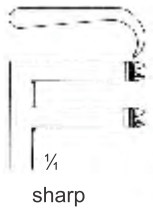

PLESTER

FM- 20-5515-13 sharp
FM- 20-5516-13 blunt
13 cm/5 1/8"

1/2

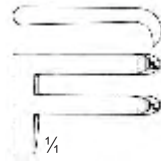

PLESTER
Blunt

FM- 20-5517-10
10.5 cm/4 1/8"

1/2

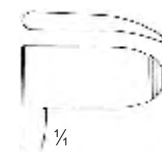

PLESTER
Blunt

FM- 20-5518-10
10.5 cm/4 1/8"

1/2

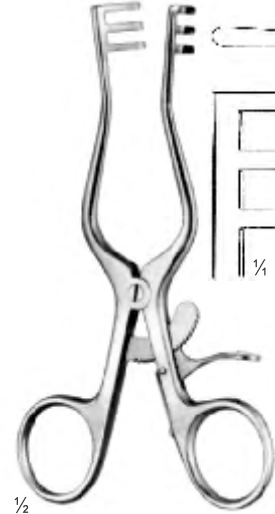
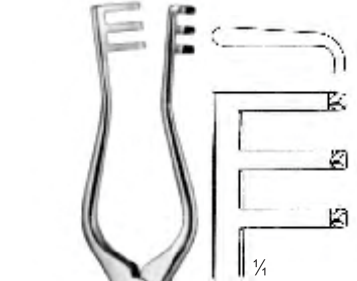

MILLIGAN
Blunt

FM- 20-5519-13
13.5 cm/5 3/8"

1/2

EN	Retractors
DE	Wundhaken
ES	Separadores
FR	Rétracteurs
IT	Divaricatori

RETRACTORS

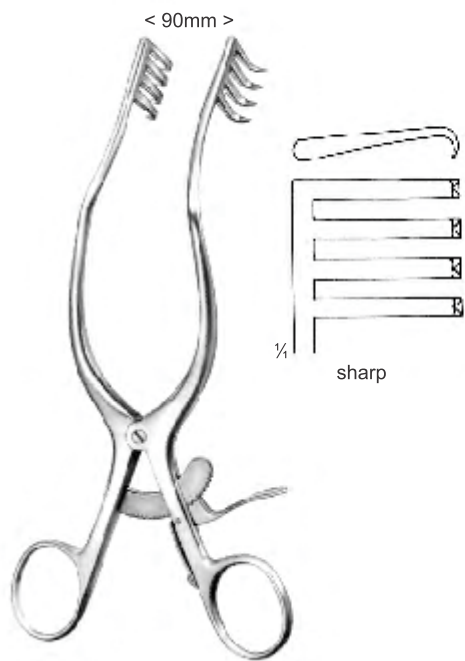

ANDERSON - ADSON
4 : 4
FM- 20-5520-19
19 cm/7 1/2"

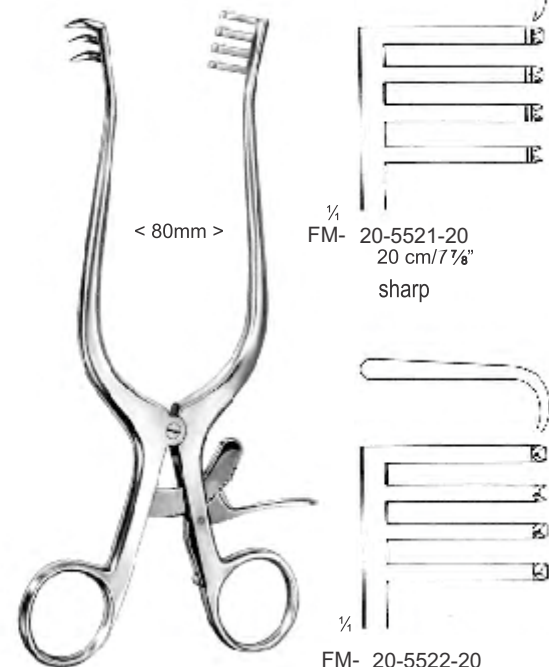

WEITLANER
3 : 4

FM- 20-5521-20
20 cm/7 7/8"
sharp

FM- 20-5522-20
20 cm/7 7/8"
blunt

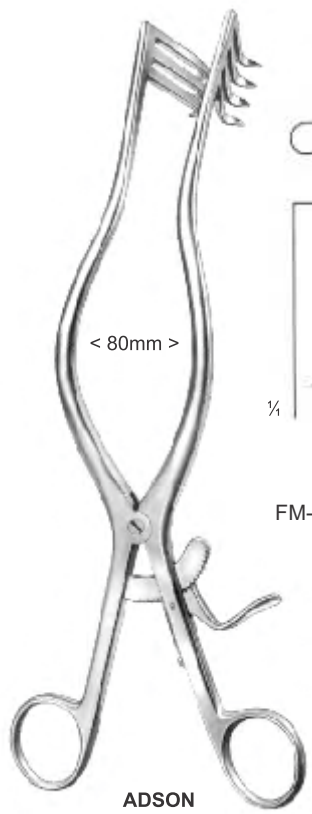

ADSON

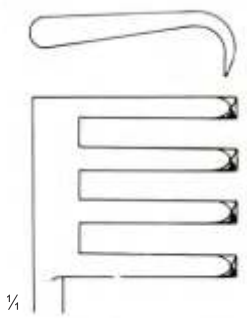

sharp
3 : 4 teeth
FM- 20-5523-26
26 cm/10 1/4"

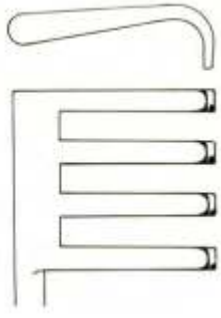

blunt
3 : 4 teeth
FM- 20-5524-26
26 cm/10 1/4"

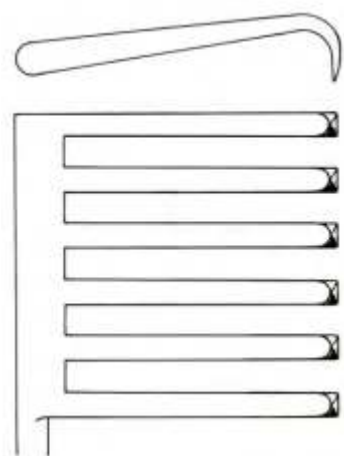

sharp
6 : 6 teeth
FM- 20-5525-29
29 cm/11 1/2"

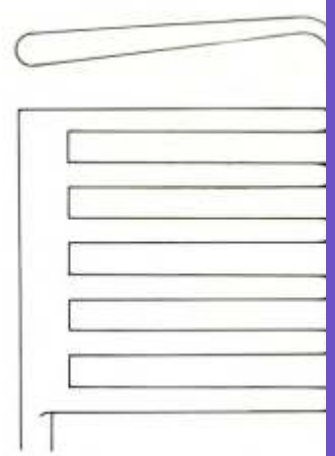

blunt
6 : 6 teeth
FM- 20-5526-29
29 cm/11 1/2"

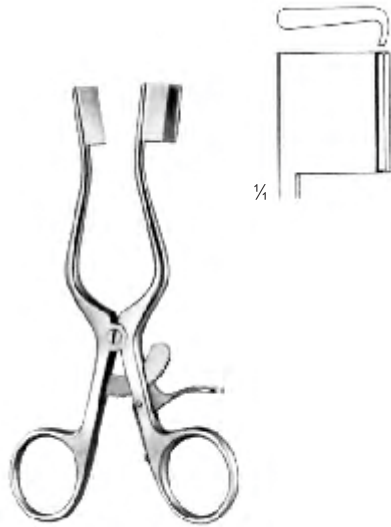

WEITLANER-BABY
FM- 20-5527-13
13.5 cm/5 3/8"

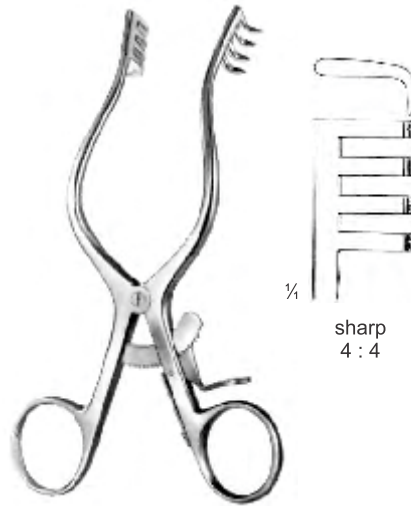

MOLLISON
FM- 20-5528-15
15.5 cm/6 1/8"

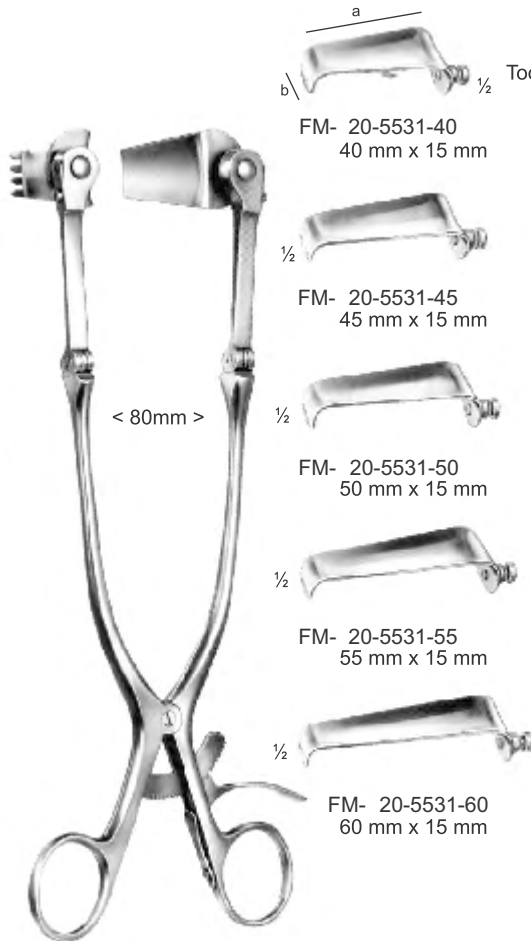

CLOWARD
FM- 20-5529-25 - Retractor complete (with 2 blades ea.)
FM- 20-5530-25 - Retractor only
25 cm/9 7/8"



CLOWARD
FM- 20-5532-16 - Retractor complete (with 2 blades ea.)
FM- 20-5533-16 - Retractor only
16 cm/6 1/4"

EN	Retractors
DE	Wundhaken
ES	Separadores
FR	Rétracteurs
IT	Divaricatori

sharp

blunt



FM- 20-5535-13
13.5 cm/5 3/8"
3 : 4



FM- 20-5536-13
13.5 cm/5 3/8"
3 : 4

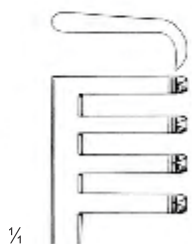

FM- 20-5537-16
16.5 cm/6 1/2"
3 : 4



FM- 20-5538-16
16.5 cm/6 1/2"
3 : 4



FM- 20-5539-21
21 cm/8 1/4"
3 : 4



FM- 20-5540-21
21 cm/8 1/4"
3 : 4

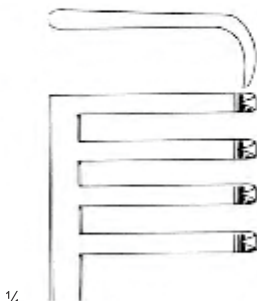

FM- 20-5541-24
24.5 cm/9 5/8"
3 : 4



FM- 20-5542-24
24.5 cm/9 5/8"
3 : 4



ADSON

Retractors **EN**
 Wundhaken **DE**
 Separadores **ES**
 Rétracteurs **FR**
 Divaricatori **IT**

20



FAIZAN & MUSA
 SPECIAL INSTRUMENTS

RETRACTORS

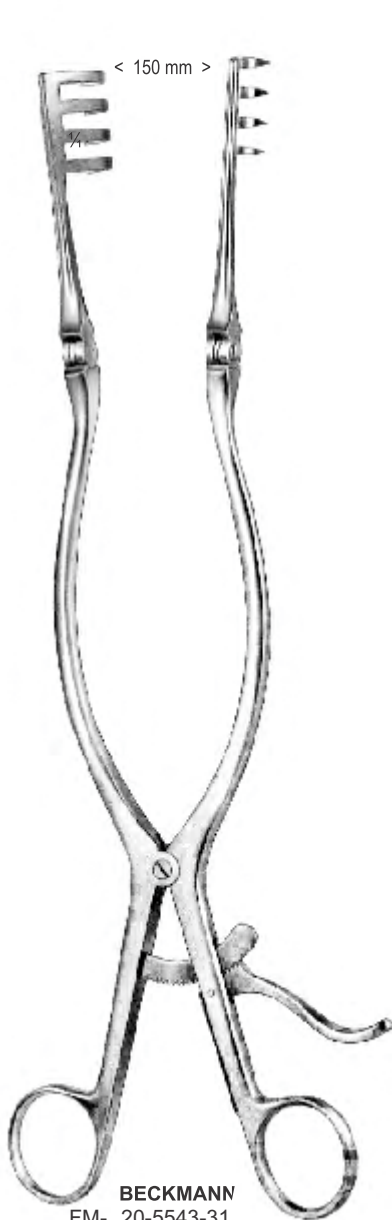
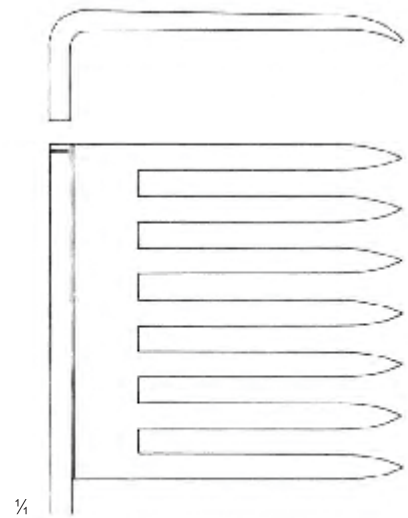

BECKMANN
 FM- 20-5543-31
 31 cm/12 1/4"
 4 : 4
 sharp

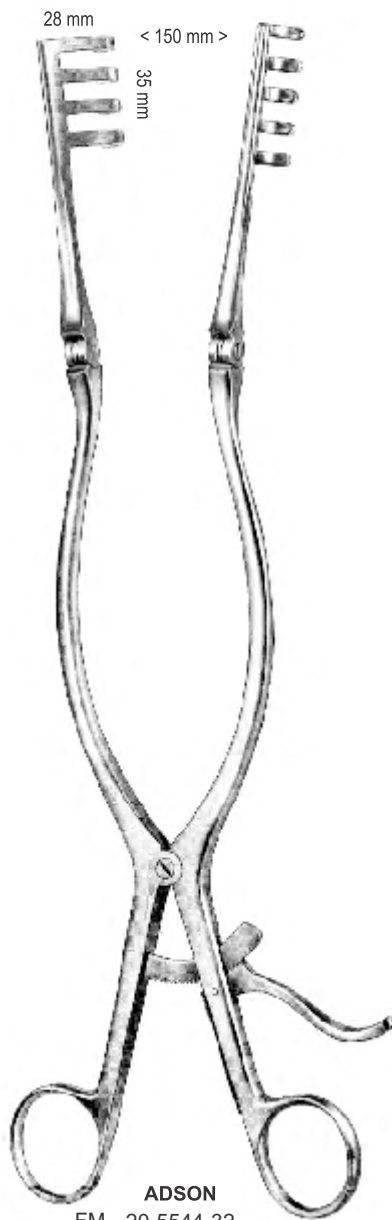

ADSON
 FM- 20-5544-32
 32 cm/12 1/2"
 4 : 5
 blunt



BECKMANN-EATON
 FM- 20-5545-32
 32 cm/12 1/2"
 7 : 7
 Sharp

Measurements of retractors: Depth x Width

EN	Retractors
DE	Wundhaken
ES	Separadores
FR	Rétracteurs
IT	Divaricatori

RETRACTORS



BECKMAN-ADSON
30.5 cm/12"
4 : 4

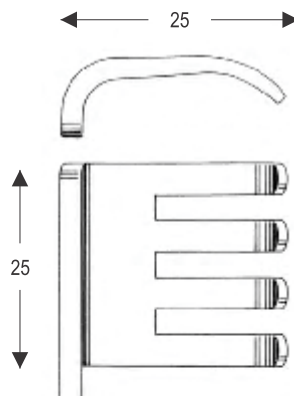

FM- 20-5546-30
blunt

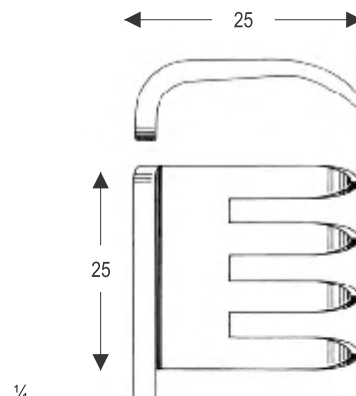

FM- 20-5547-30
sharp

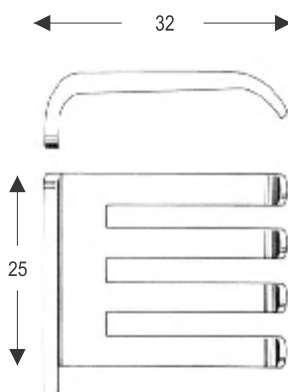

FM- 20-5548-30
blunt

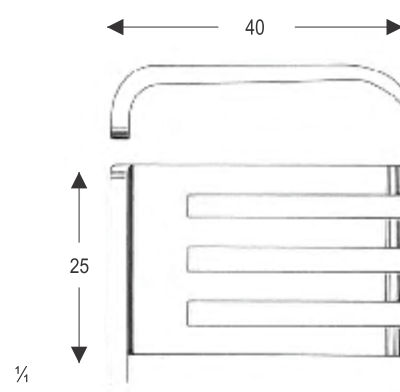

FM- 20-5549-30
blunt

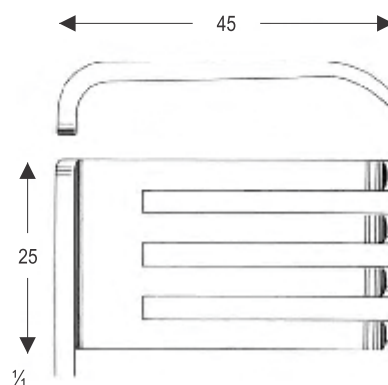

FM- 20-5550-30
blunt



1/2

28.5 cm/11 1/4"
6 : 6

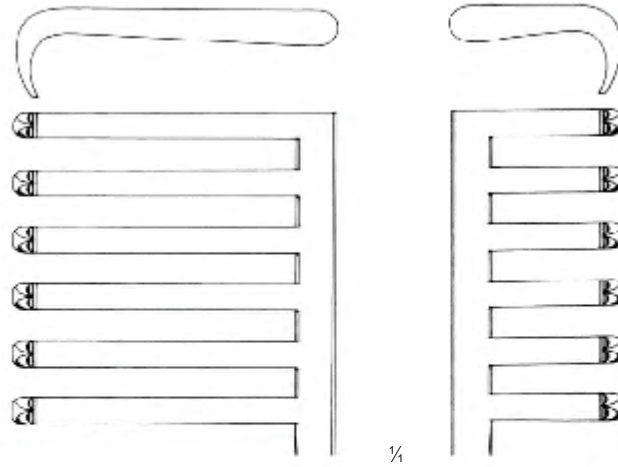

FM- 20-5551-28
Sharp, long teeth on left side

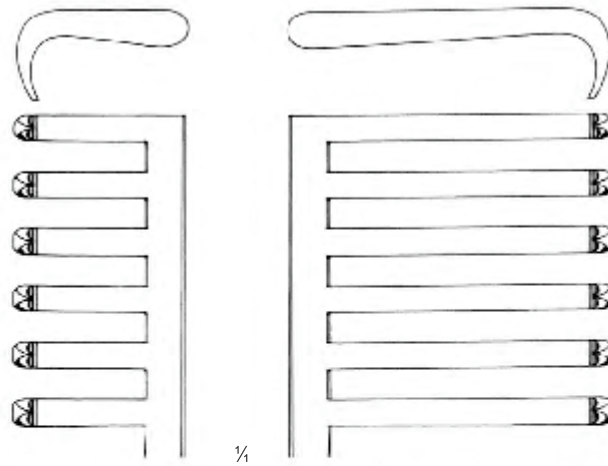

FM- 20-5552-28
Sharp, long teeth on right side

EN	Retractors
DE	Wundhaken
ES	Separadores
FR	Rétracteurs
IT	Divaricatori



MEYERDING
19 cm/7 1/2"

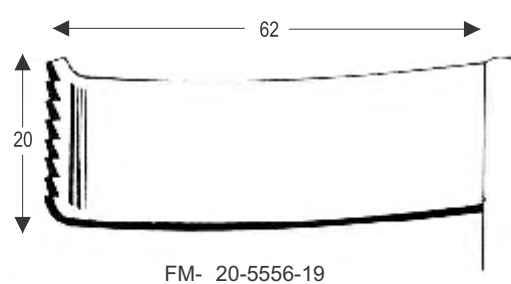
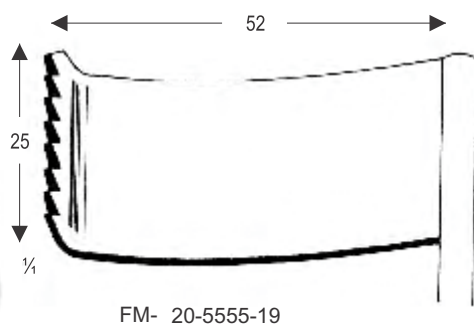
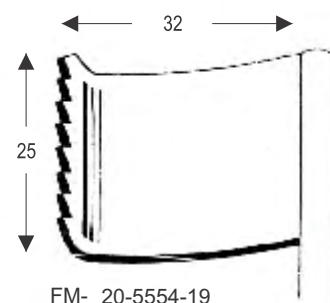
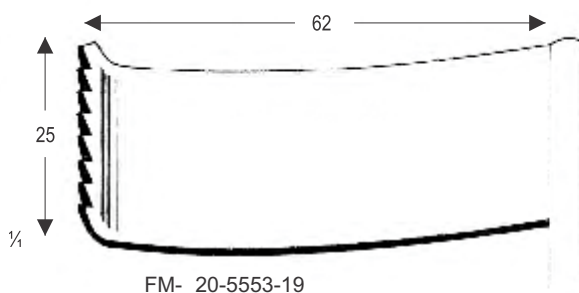

Measurements of retractors: Depth x Width

Retractors **EN**
 Wundhaken **DE**
 Separadores **ES**
 Rétracteurs **FR**
 Divaricatori **IT**

20



RETRACTORS

Lateral Blade
25 x 50 mm



MARKHAM-MEYERDING
 FM- 20-5557-18
 18 cm/7 1/8"

Lateral Blade
25 x 50 mm



MARKHAM-MEYERDING
 FM- 20-5558-18
 18 cm/7 1/8"



HENLEY
 16 cm/6 1/4"

FM- 20-5559-16
 19 x 16 mm

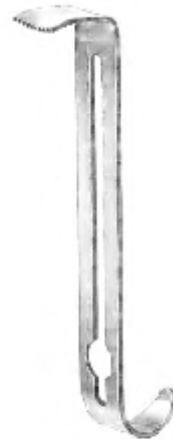

FM- 20-5560-16
 25 x 16 mm

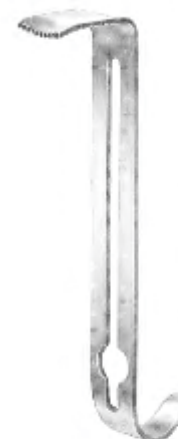

FM- 20-5561-16
 32 x 16 mm

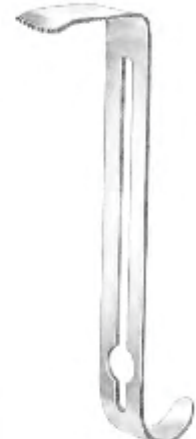

Measurements of retractors: Depth x Width

EN	Abdominal Retractors
DE	Bauchdeckenhalter
ES	Separadores abdominales
FR	Rétracteurs abdominaux
IT	Divaricatori addominali



GELPI

FM- 20-5562-09	9 cm/3 1/2"
FM- 20-5562-11	11 cm/4 3/8"
FM- 20-5562-13	13 cm/5 1/8"
FM- 20-5562-14	14 cm/5 1/2"
FM- 20-5562-16	16 cm/6 1/4"
FM- 20-5562-18	18 cm/7 1/8"



GELPI-LOKTITE

FM- 20-5563-09	9 cm/3 1/2"
FM- 20-5563-11	11 cm/4 3/8"
FM- 20-5563-13	13 cm/5 1/8"
FM- 20-5563-14	14 cm/5 1/2"
FM- 20-5563-16	16 cm/6 1/4"
FM- 20-5563-18	18 cm/7 1/8"

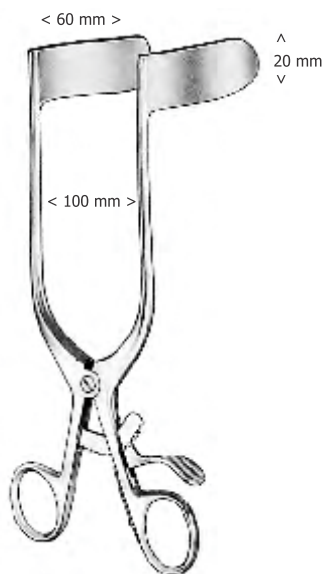

RIGBY

FM- 20-5564-19	
(Rectum, Vagina)	
19 cm/7 1/2"	

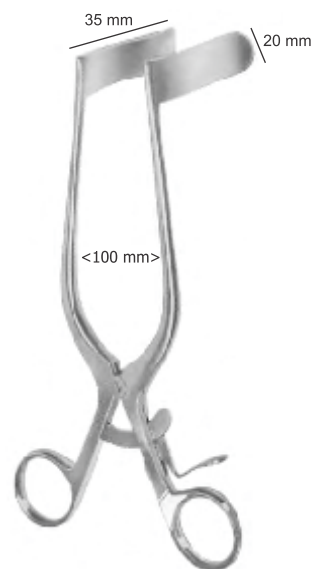

FM- 20-5565-18
18 cm/7 1/8"

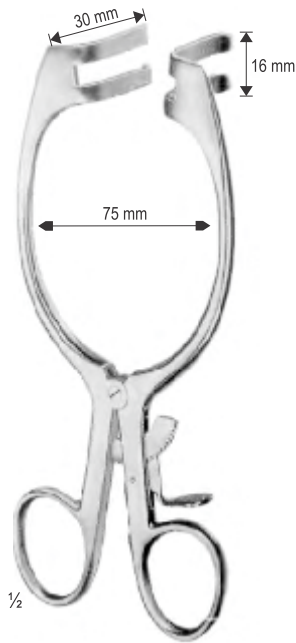

MAYO-ADAMS
 FM- 20-5566-16
 16.5 cm/6 1/2"

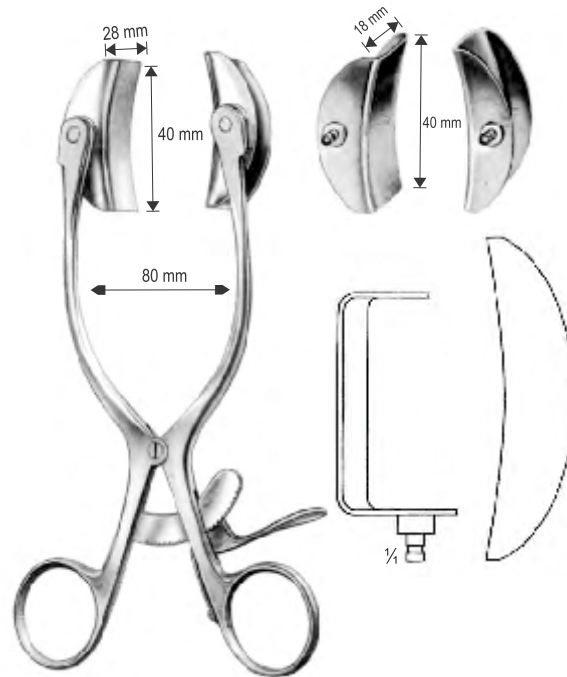

BABY-COLLIN complete, with 2 pairs of exchangeable blades
 FM- 20-5567-00

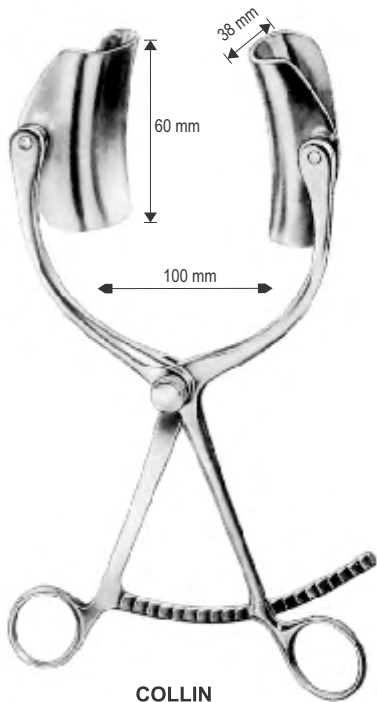

COLLIN
 FM- 20-5568-38



Measurements see below

Exchangeable Blades

	Lateral Blades	Central Blades
FM- 20-5569-38	38 x 60 mm	/ 38 x 55 mm
FM- 20-5570-38	38 x 80mm	/ 50 x 75mm

EN	Abdominal Retractors
DE	Bauchdeckenhalter
ES	Separadores abdominales
FR	Rétracteurs abdominaux
IT	Divaricatori addominali

Exchangeable Blades

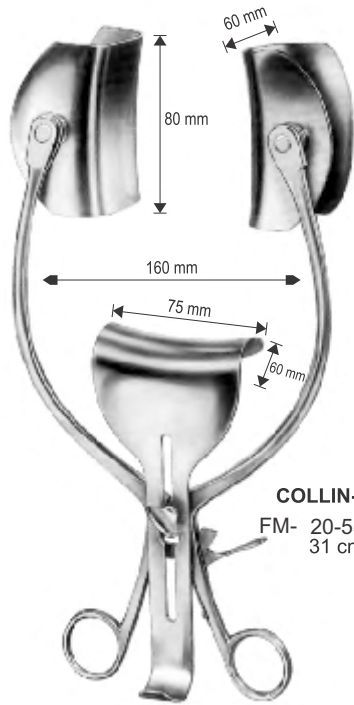

COLLIN-LOCKTITE

FM- 20-5571-31
31 cm 12 1/4"

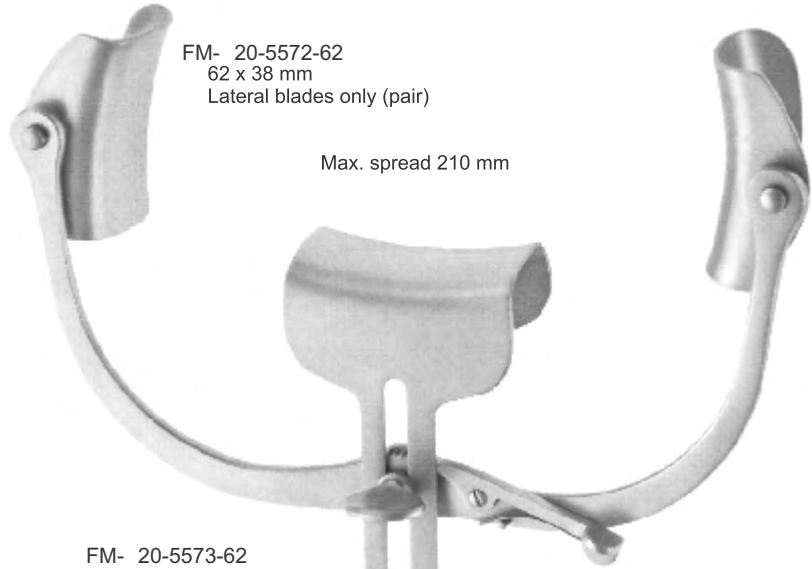

FM- 20-5572-62
62 x 38 mm
Lateral blades only (pair)

Max. spread 210 mm

FM- 20-5573-62
Frame only

FM- 20-5574-64
64 x 40 mm
Center blade only

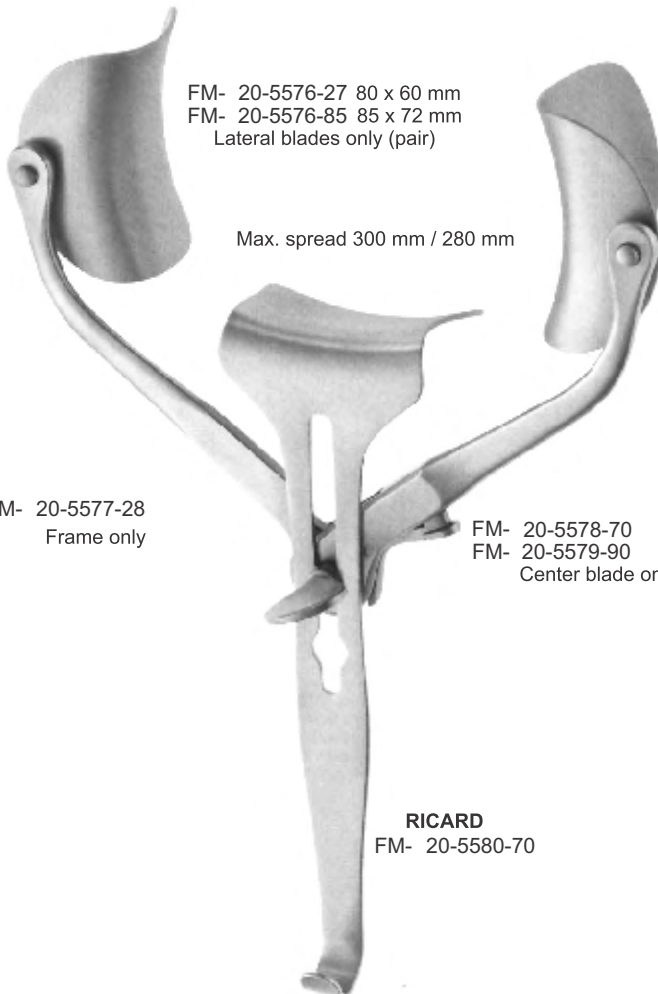

FM- 20-5576-27 80 x 60 mm
FM- 20-5576-85 85 x 72 mm
Lateral blades only (pair)

Max. spread 300 mm / 280 mm

FM- 20-5577-28
Frame only

FM- 20-5578-70 70 x 55 mm
FM- 20-5579-90 90 x 80 mm
Center blade only

ROBIN-MASSE
FM- 20-5575-64

RICARD
FM- 20-5580-70

Measurements of retractors: Depth x Width

RETRACTORS

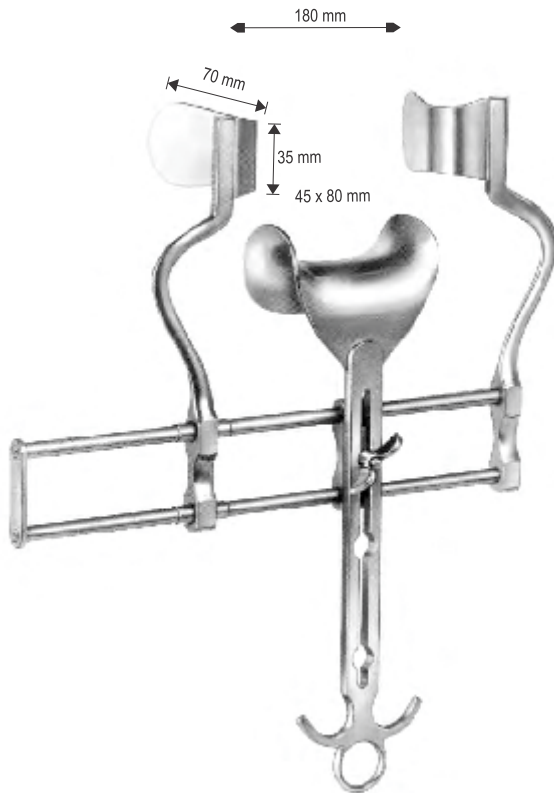

BALFOUR
 FM- 20-5581-20
 20 cm/7 7/8"

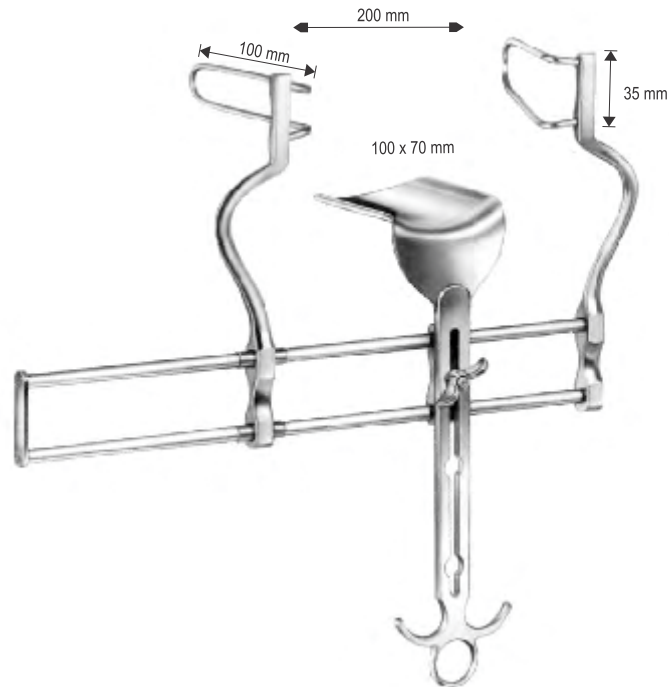

BALFOUR
 FM- 20-5582-20

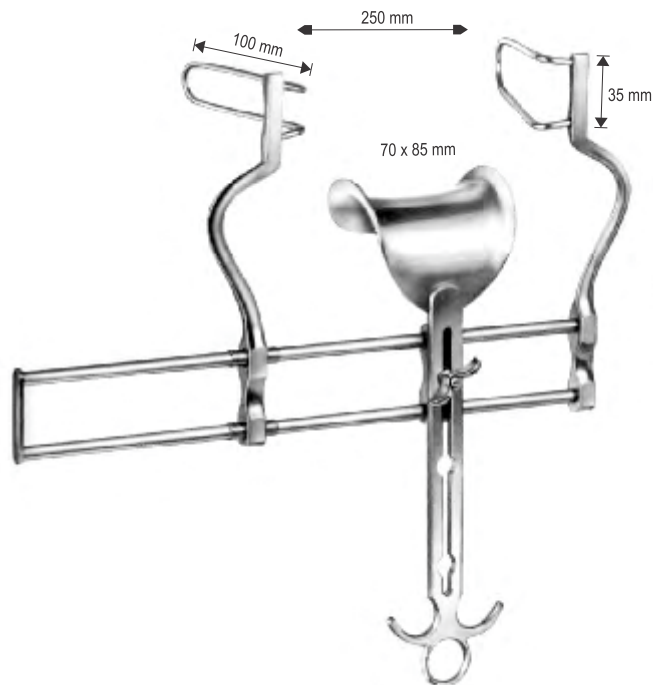

BALFOUR
 FM- 20-5583-00

Centre Blade only



BALFOUR
 FM- 20-5584-45 = 45 X 80 mm
 FM- 20-5584-70 = 70 X 85 mm
 FM- 20-5584-80 = 80 X 90 mm

Measurements of retractors: Depth x Width

EN	Abdominal Retractors
DE	Bauchdeckenhalter
ES	Separadores abdominales
FR	Rétracteurs abdominaux
IT	Divaricatori addominali



GOSSET-BABY
FM- 20-5585-12
12.5 cm/4 7/8"

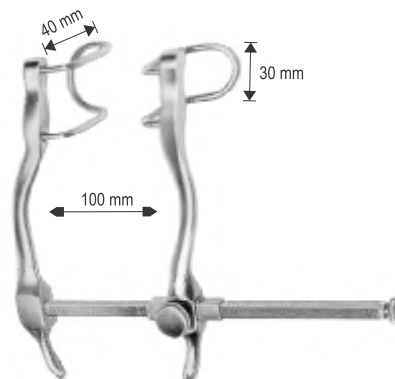

GOSSET
FM- 20-5586-12

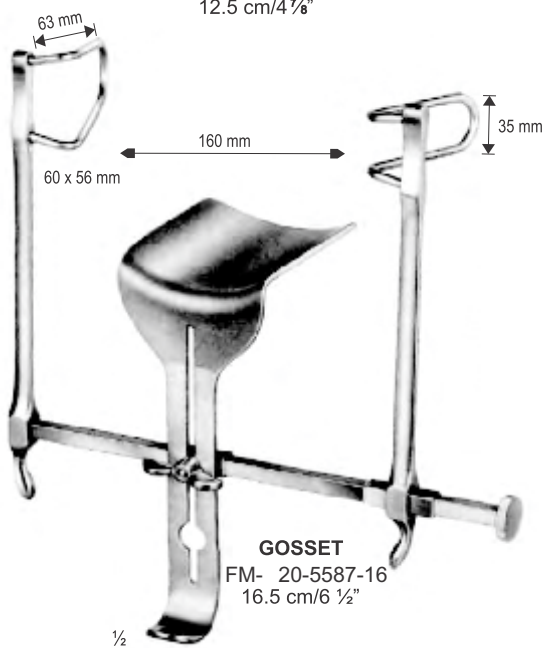

GOSSET
FM- 20-5587-16
16.5 cm/6 1/2"

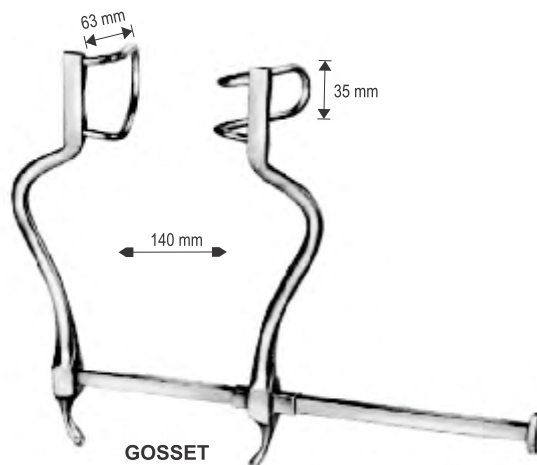

GOSSET
FM- 20-5588-18
18.5cm/7 1/4"

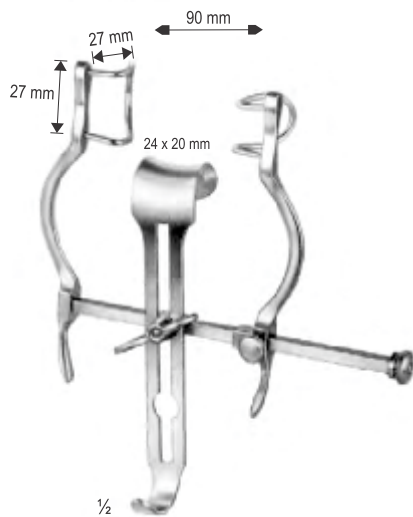

BALFOUR-BABY
FM- 20-5589-12
12.5cm/4 7/8"

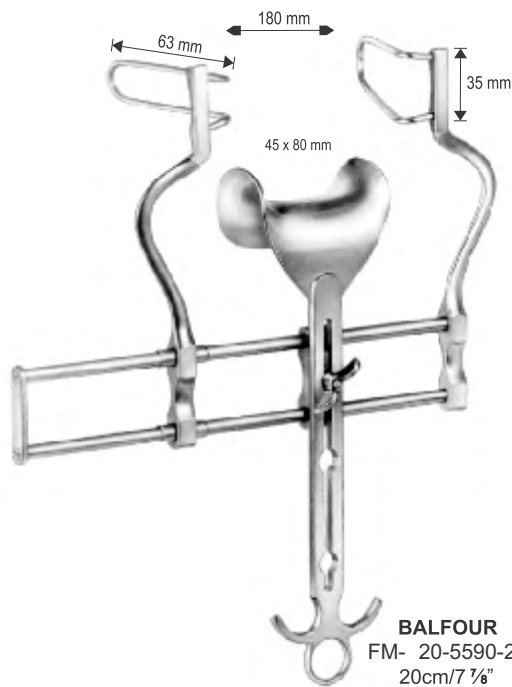

BALFOUR
FM- 20-5590-20
20cm/7 7/8"

Measurements of retractors: Depth x Width

Abdominal Retractors EN

Bauchdeckenhalter DE

Separadores abdominales ES

Rétracteurs abdominaux FR

Divaricatori addominali IT

20



FAIZAN & MUSA
SPECIAL INSTRUMENTS

RETRACTORS

FM- 20-5591-50 50 x 98 mm

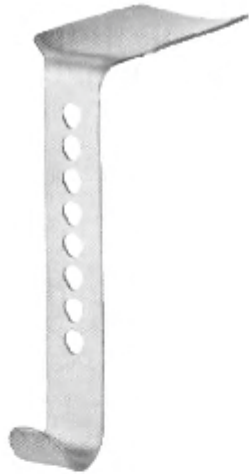

FM- 20-5593-35 35 x 105 mm



FM- 20-5592-94 94 x 83 mm

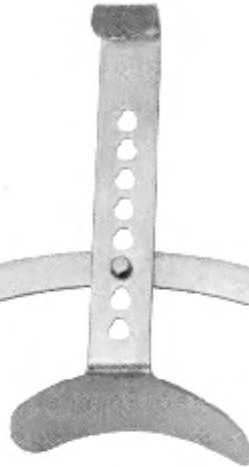

FM- 20-5594-57 57 x 45 mm

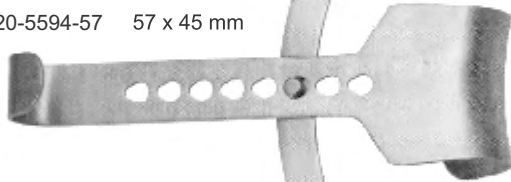

FM- 20-5595-57 57 x 45 mm

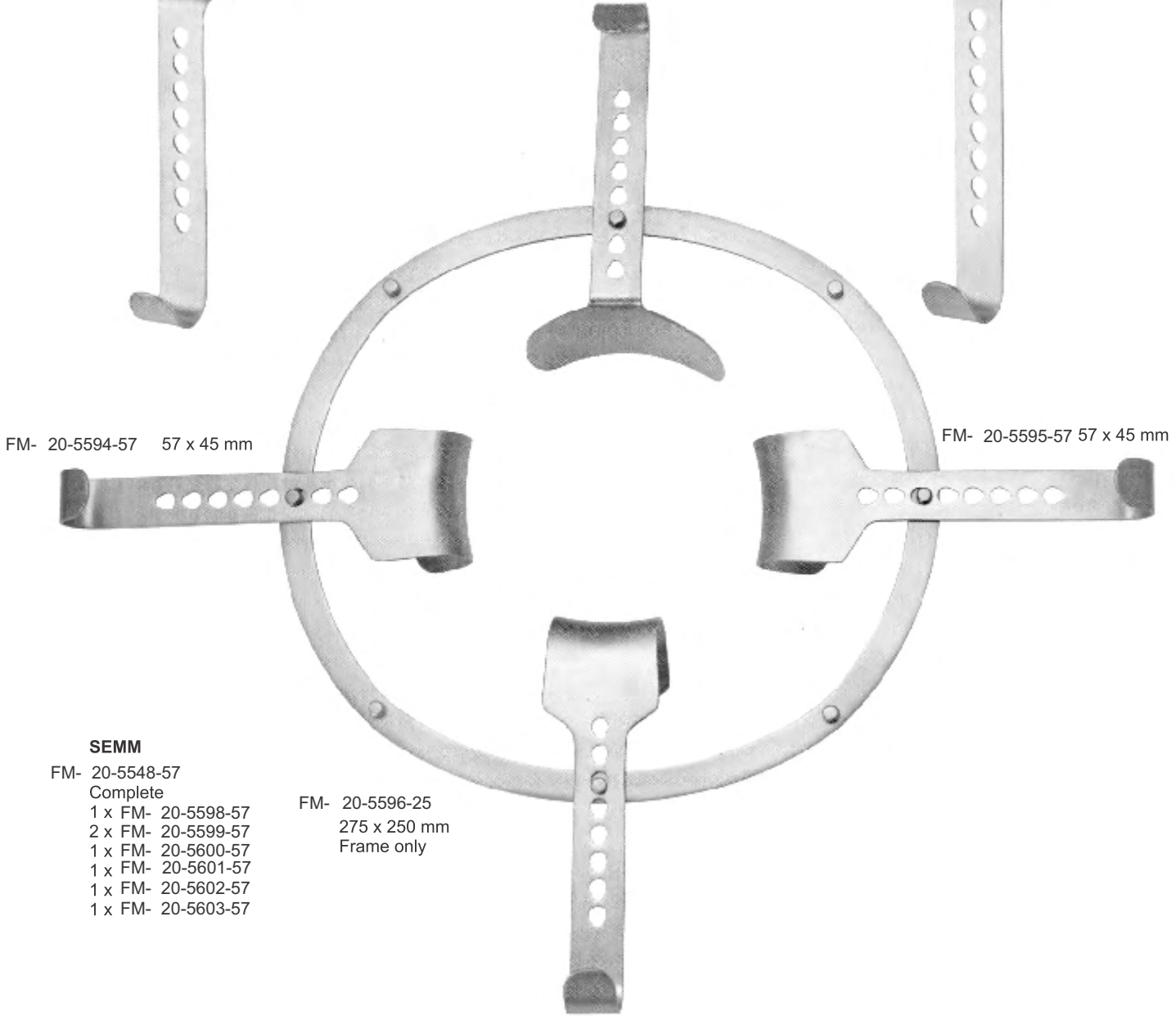

FM- 20-5596-25
275 x 250 mm
Frame only

FM- 20-5597-54 54 x 50 mm

SEMM

FM- 20-5548-57

Complete

1 x FM- 20-5598-57

2 x FM- 20-5599-57

1 x FM- 20-5600-57

1 x FM- 20-5601-57

1 x FM- 20-5602-57

1 x FM- 20-5603-57

Measurements of retractors: Depth x Width

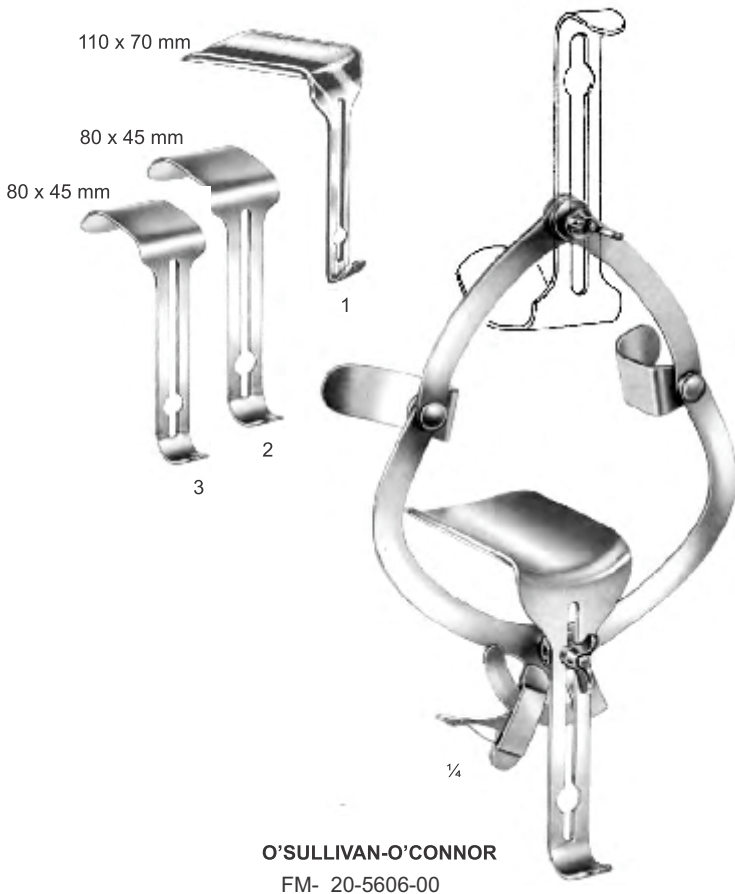
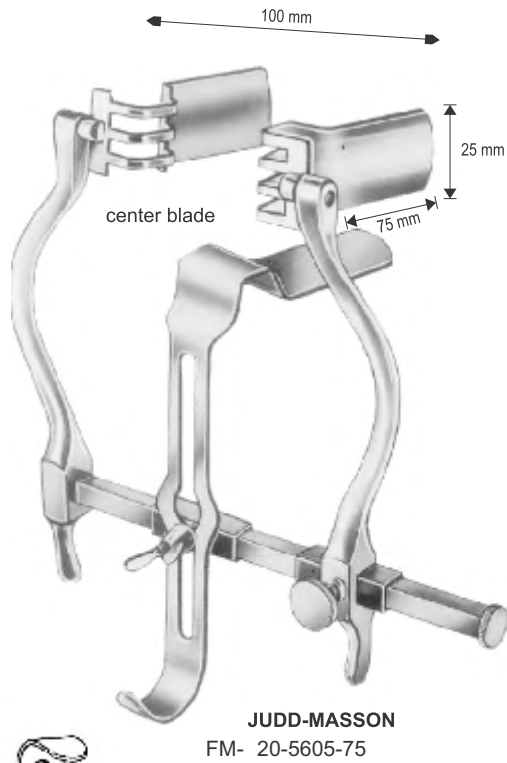
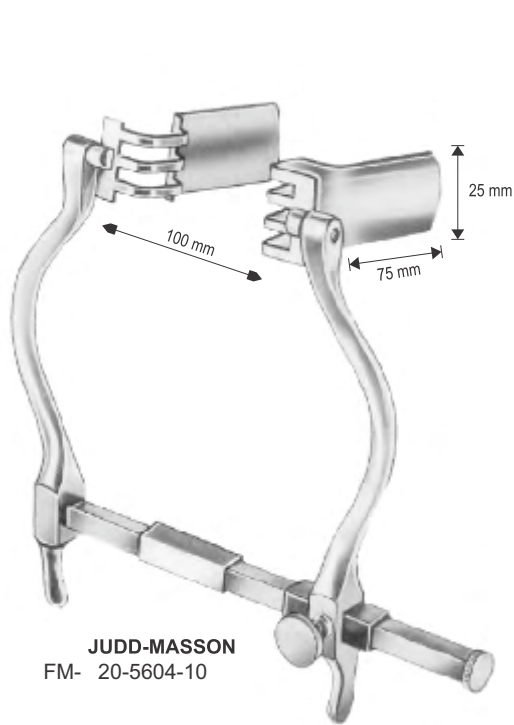

- DOYEN**
- FM- 20-5607-55 55 x 95 mm
 - FM- 20-5608-55 55 x 105 mm
 - FM- 20-5609-55 55 x 115 mm
 - FM- 20-5610-55 55 x 125 mm

Measurements of retractors: Depth x Width

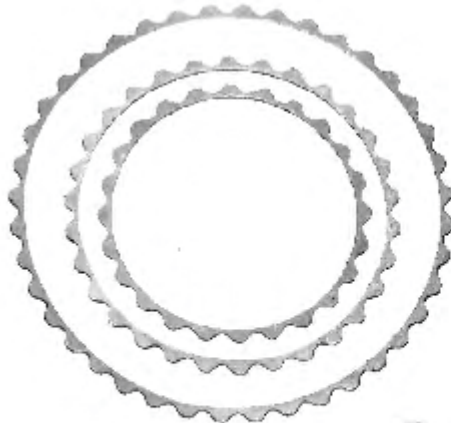

TURNER-WARWICK
20-5612-33
Retractor frame, oval
457 x 330 mm

TURNER-WARWICK
Retractor frame, round

- FM- 20-5611-18 Ø 18 cm/7 1/8"
- FM- 20-5611-23 Ø 23cm/9"
- FM- 20-5611-30 Ø 30.5cm/12"

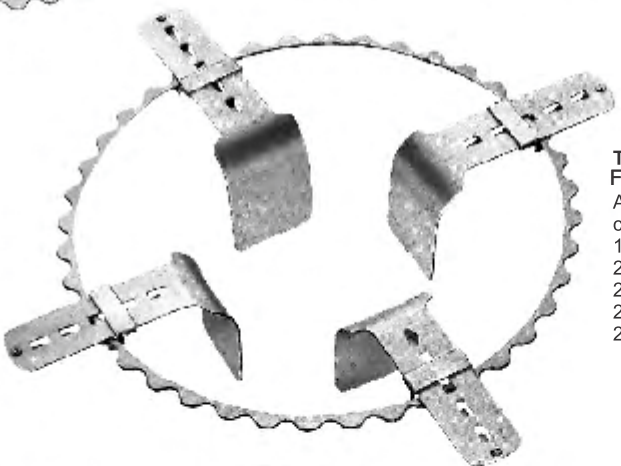

TURNER-WARWICK
FM- 20-5613-33
Abdominal retractor, complete
consisting of
1 frame 20-5614-33
2 retractor blades of eac 20-5615-33
2 abdominal retractor of each 20-5616-33
2 abdominal retractor of each 20-5617-33
2 retractor blade single hooks 20-5618-33

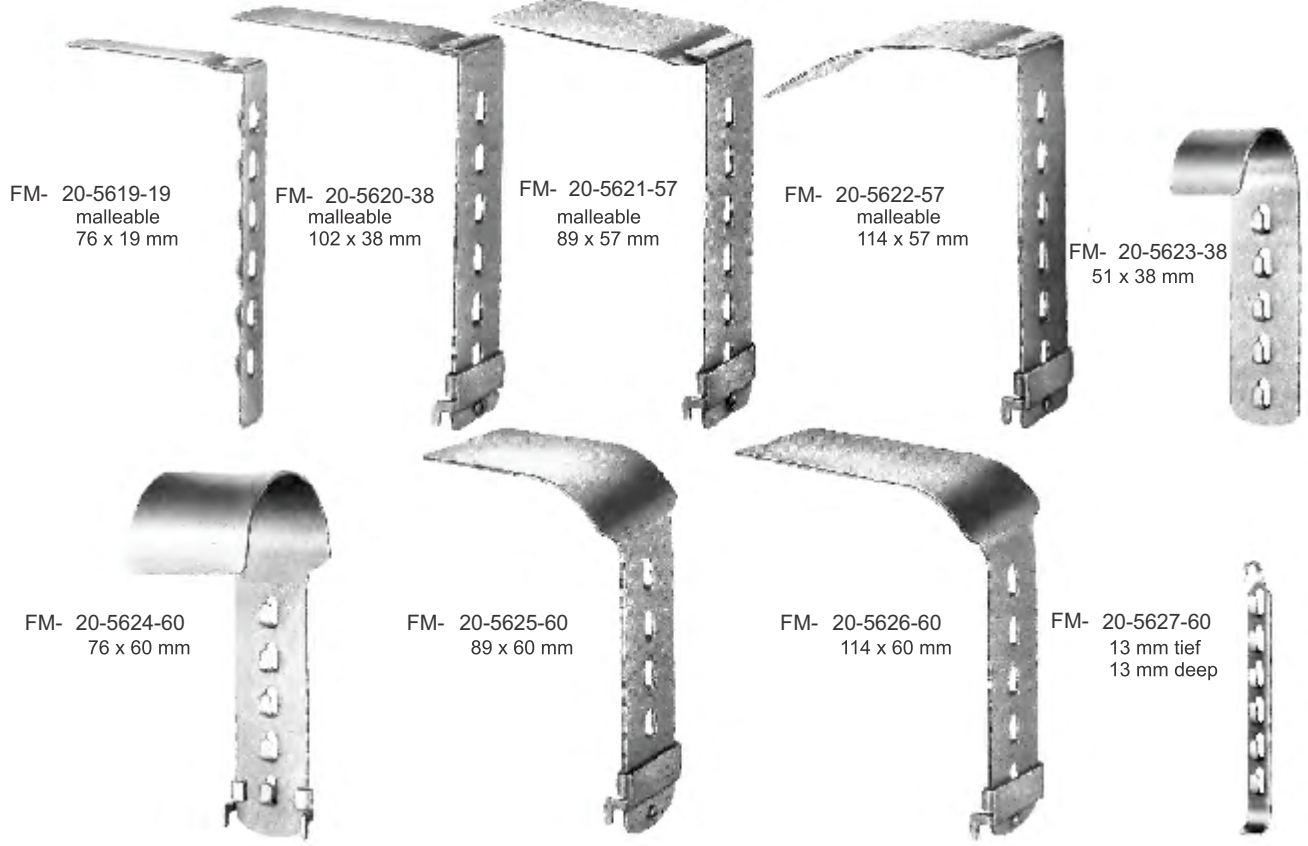

FM- 20-5619-19
malleable
76 x 19 mm

FM- 20-5620-38
malleable
102 x 38 mm

FM- 20-5621-57
malleable
89 x 57 mm

FM- 20-5622-57
malleable
114 x 57 mm

FM- 20-5623-38
51 x 38 mm

FM- 20-5624-60
76 x 60 mm

FM- 20-5625-60
89 x 60 mm

FM- 20-5626-60
114 x 60 mm

FM- 20-5627-60
13 mm tief
13 mm deep

EN	Dermatology
DE	Dermatologie
ES	Dermatología
FR	Dermatologie
IT	Dermatologia

Page 301 to 302



Comedone Extractors

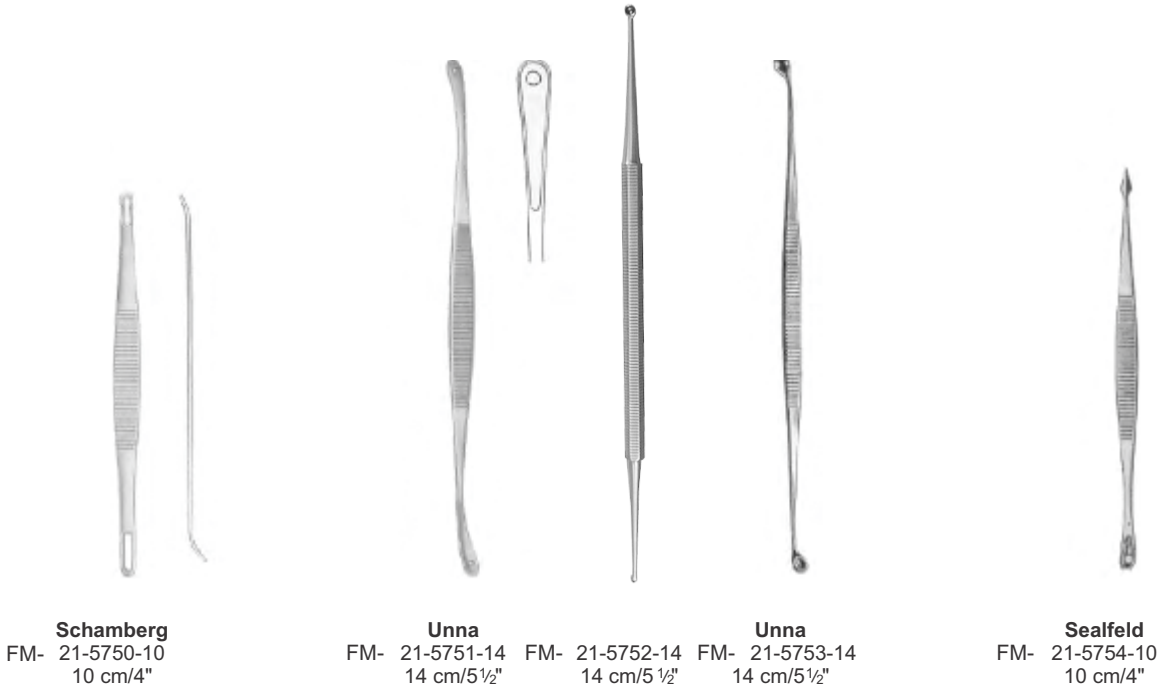

Skin Curettes

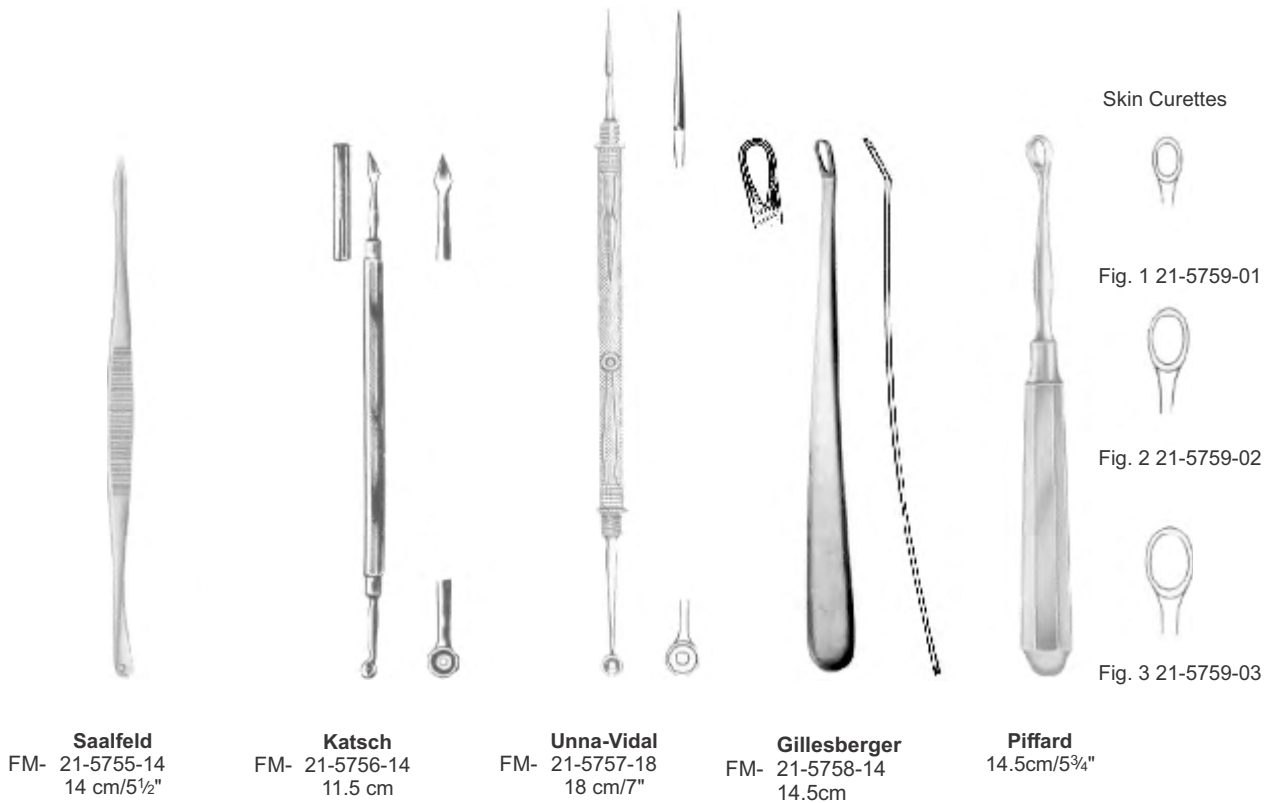

Lupus Curettes

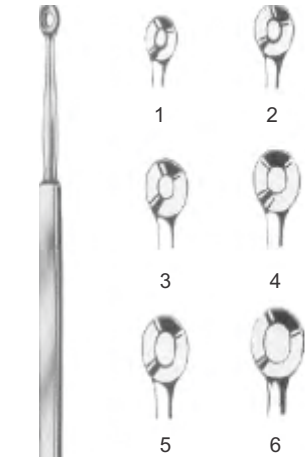
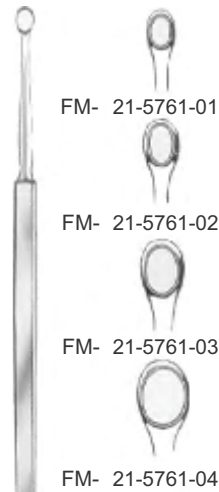

Fig.
 1 FM- 21-5760-01
 2 FM- 21-5760-02
 3 FM- 21-5760-03
 4 FM- 21-5760-04
 5 FM- 21-5760-05
 6 FM- 21-5760-06

Wolff
 14 cm/5½"

Lupus Curettes Lupus Scraper



Fox
 14 cm/5½"

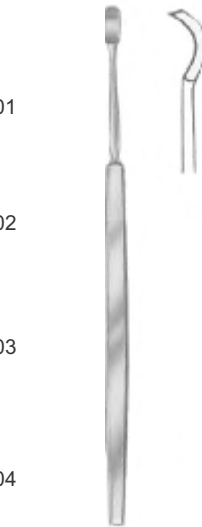

Vidal
 FM- 21-5762-14
 14 cm/5½"

Moncorps Knife



Moncorps
 FM- 21-5763-14
 14 cm/5½"

Cutaneous Hook

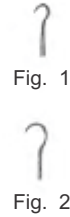

Gillies
 Fig. 1 21-5764-01
 Fig. 2 21-5764-02
 18 cm/7"



Kilner
 FM- 21-5765-15
 15 cm/6"

- 1 ○ FM- 21-5766-02 2mm
- 2 ○ FM- 21-5766-03 3mm
- 3 ○ FM- 21-5766-04 4mm
- 4 ○ FM- 21-5766-05 5mm
- 5 ○ FM- 21-5766-06 6mm
- 6 ○ FM- 21-5766-07 7mm
- 7 ○ FM- 21-5766-08 8mm



KEYS
 10.0cm



FM- 21-5767-00
 Biopsy set for taking skin specimen
 core drills 1.5, 3.0, 4.5mm ø

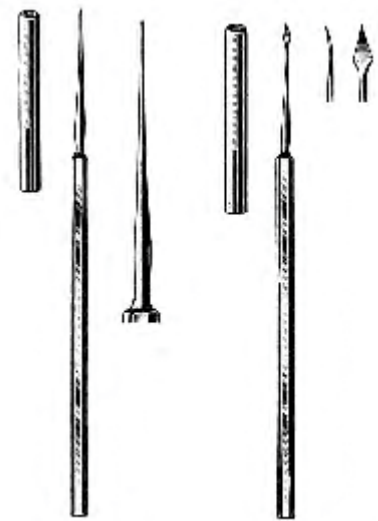

FM- 21-5768-13
 13.0cm

FM- 21-5769-13
 13.0cm

EN	Tracheotomy
DE	Tracheotomie
ES	Traqueotomía
FR	Trachéotomie
IT	Tracheotomia

Page 303 to 305



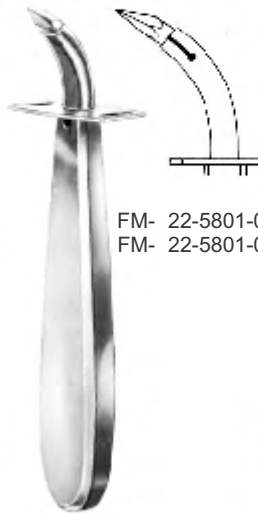

FM- 22-5801-07 7.5mm Ø
 FM- 22-5801-09 9mm Ø

UCKERMANN
 13.0cm



TROUSSEAU
 FM- 22-5802-12 12.0cm
 FM- 22-5802-14 14.0cm



LABORDE
 FM- 22-5803-14
 14.0cm



WEERDA
 FM- 22-5804-09
 19.0cm



FM- 22-5806-01



FM- 22-5806-02



BOSE
 FM- 22-5805-07
 7.0cm

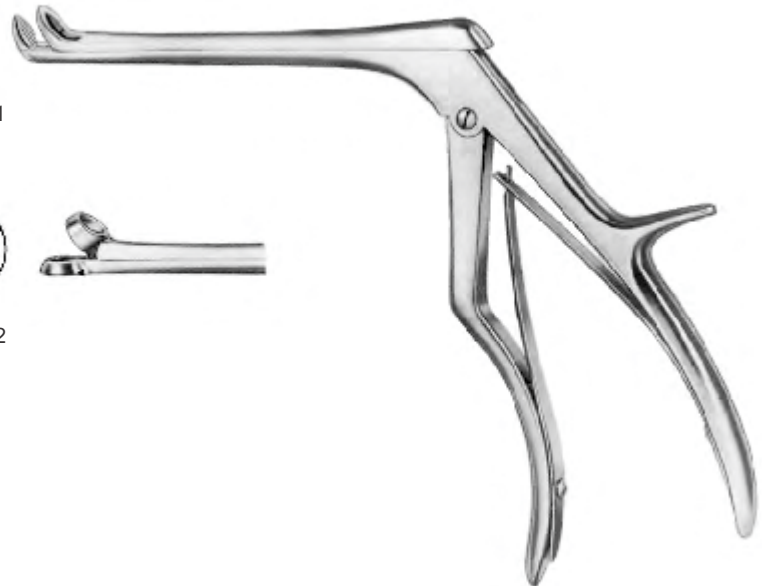

Trachea Retractors EN

Tracheal-Häkchen DE

Separadores para le tráquea ES

Tracteurs Retracteurs FR

Retrattori della trachea IT

22



FAIZAN & MUSA
SPECIAL INSTRUMENTS

TRACHEOTOMY



ROSE
FM- 22-5814-13
13.0cm



LUER
FM- 22-5815-11
11.0cm



JACKSON
FM- 22-5816-15
15.0cm



FM- 22-5817-15
15.0cm



ITERSON
16.0cm



FM- 22-5818-01
Sharp



FM- 22-5818-02
Blunt



BOSE
FM- 22-5819-16
16.0cm

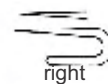

BOSE
FM- 22-5820-16
16.0cm

EN Trachea Tubes

DE Tracheal-Kanülen

ES Cánulas traqueales

FR Tubes de trachée

IT Tubi di trachea

FAIZAN & MUSA
SPECIAL INSTRUMENTS**KRISHABER**

Fig	mm
0	4 FM- 22-5825-04
1	5 FM- 22-5825-05
2	6 FM- 22-5825-06
3	7 FM- 22-5825-07
4	8 FM- 22-5825-08
5	9 FM- 22-5825-09
6	10 FM- 22-5825-10
7	11 FM- 22-5825-11
8	12 FM- 22-5825-12

**KRISHABER-LUER**

Fig	mm
0	4 FM- 22-5826-04
1	5 FM- 22-5826-05
2	6 FM- 22-5826-06
3	7 FM- 22-5826-07
4	8 FM- 22-5826-08
5	9 FM- 22-5826-09
6	10 FM- 22-5826-10
7	11 FM- 22-5826-11
8	12 FM- 22-5826-12

**PARKER**

Fig	F.G
1	16 FM- 22-5827-16
2	18 FM- 22-5827-18
3	20 FM- 22-5827-20
4	22 FM- 22-5827-22
5	24 FM- 22-5827-24
6	26 FM- 22-5827-26
7	28 FM- 22-5827-28
8	30 FM- 22-5827-30
9	32 FM- 22-5827-32

**COLLIN**

Fig	mm
0	4 FM- 22-5828-04
1	5 FM- 22-5828-05
2	6 FM- 22-5828-06
3	7 FM- 22-5828-07
4	8 FM- 22-5828-08
5	9 FM- 22-5828-09
6	10 FM- 22-5828-10
7	11 FM- 22-5828-11
8	12 FM- 22-5828-12

**FULLER**

Fig	F.G
1	18 FM- 22-5829-18
2	20 FM- 22-5829-20
3	22 FM- 22-5829-22
4	24 FM- 22-5829-24
5	26 FM- 22-5829-26
6	28 FM- 22-5829-28
7	30 FM- 22-5829-30
8	32 FM- 22-5829-32

**CUBLEY**

Fig	F.G
1	16 FM- 22-5830-16
2	18 FM- 22-5830-18
3	20 FM- 22-5830-20
4	22 FM- 22-5830-22
5	24 FM- 22-5830-24
6	26 FM- 22-5830-26
7	28 FM- 22-5830-28
8	30 FM- 22-5830-30
9	32 FM- 22-5830-32

EN	Ophthalmology
DE	Ophthalmologie
ES	Oftalmología
FR	Ophtalmologie
IT	Oftalmologia

Page 306 to 315

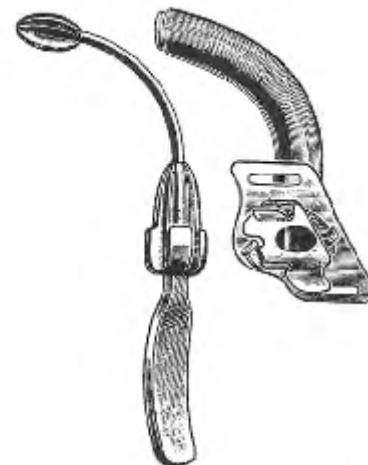

EN	Eye Speculas
DE	Lidsperrer
ES	Espéculos ojo
FR	Spéculums pour les yeux
IT	Eye Speculas



FAIZAN & MUSA

OPHTHALMOLOGY



Weiss
Children FM- 23-5901-07 7 cm/2¾"
Adults FM- 23-5902-09 9 cm/3½"



Weiss
Children FM- 23-5903-07 7 cm/2¾"
Adults FM- 23-5904-09 9 cm/3½"



Park
FM- 23-5905-08 8 cm/3¼"



Park-Guyton
FM- 23-5906-08 8 cm/3¼"



Park-Maumenee
FM- 23-5907-08 8 cm/3¼"



Barraquer (Colibri)
Children FM- 23-5908-03 3 cm/1¼"
Adults FM- 23-5909-04 4 cm/1½"



Sauer
FM- 23-5912-03 3 cm/1¼"



Barraquer
FM- 23-5910-04 4 cm/1½"



Bowman
FM- 23-5911-07 7 cm/2¾"



Goldstein
FM- 23-5913-03 3 cm/1¼"



Pley
FM- 23-5914-06 6 cm/2¼"

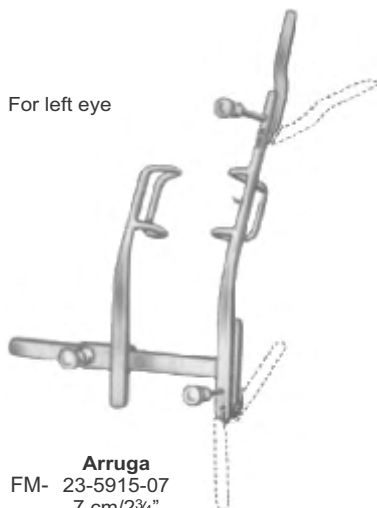

Arruga
FM- 23-5915-07 7 cm/2¾"

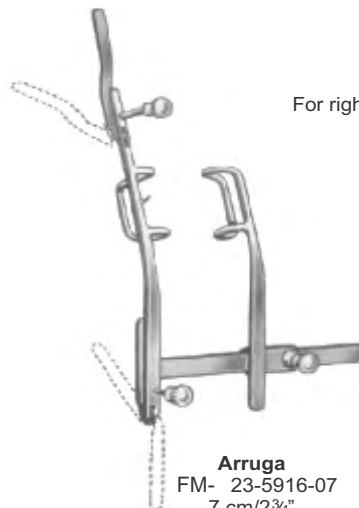

Arruga
FM- 23-5916-07 7 cm/2¾"

Eye Speculas **EN**
 Lidsperrer **DE**
 Espéculos ojo **ES**
 Spéculums pour les yeux **FR**
 Eye Speculas **IT**

23



Mellinger-Axenfeld
 FM- 23-5917-07
 7 cm/2 3/4"



Mellinger-Axenfeld
 FM- 23-5918-07
 7 cm/2 3/4"



Mellinger
 Children FM- 23-5919-05
 5 cm/2 3/4"
 Adults FM- 23-5920-07
 7 cm/2 3/4"



Mellinger Beard
 Children FM- 23-5921-05
 5 cm/2"
 Adults FM- 23-5922-07
 7 cm/2 3/4"



Knapp Clark
 FM- 23-5923-08
 8 cm/3 1/4"



Graefe
 Children FM- 23-5924-06
 6 cm/2 1/2"
 Adults FM- 23-5925-09
 9 cm/3 1/2"



Lancaster
 FM- 23-5926-08
 8 cm/3 1/4"



Williams
 Children FM- 23-5927-07
 7 cm/2 3/4"
 Adults FM- 23-5928-08
 8 cm/3 1/4"



Lister-Burch
 FM- 23-5929-08
 8 cm/3 1/4"



Weiss
 FM- 23-5930-08
 8 cm/3 1/4"



Murdock
 FM- 23-5931-05
 5 cm/2"



Mueller
 FM- 23-5932-07
 7 cm/2 3/4"



Critchett
 FM- 23-5933-06
 6 cm/2 1/2"



Castroviejo
 FM- 23-5934-08
 8 cm/3 1/4"

EN	Various Eye Knives
DE	Verschiedene Eye Messer
ES	Varios cuchillos de ojos
FR	Divers couteaux d'oeil
IT	Vari coltelli per gli occhi



Mod. Hamburg
FM- 23-5957-12



Graefe
FM- 23-5958-13



FM- 23-5959-01



Weber
FM- 23-5959-02



FM- 23-5959-03



Bowman
FM- 23-5960-04
0.4 mm



Bowman
FM- 23-5960-05
0.5 mm



Bowman
FM- 23-5960-06
0.6 mm



Bowman
FM- 23-5960-07
0.7 mm



Bowman
FM- 23-5960-08
0.8 mm



Left **Bowman** Right
FM- 23-5961-01 FM- 23-5961-02



FM- 23-5962-01



Knapp
FM- 23-5962-02



FM- 23-5962-03



FM- 23-5963-05
5 mm



Ziegler
FM- 23-5963-06
6 mm



FM- 23-5963-07
7 mm

Various Eye Knives	EN
Verschiedene Eye Messer	DE
Varios cuchillos de ojos	ES
Divers couteaux d'oeil	FR
Vari coltelli per gli occhi	IT

23



Dean
FM- 23-5964-13



Zigler
FM- 23-5965-11
3½ mm



Sato
FM- 23-5966-12



Sichel
FM- 23-5967-13



Graefe
FM- 23-5968-13



Graefe
FM- 23-5969-13



Dean
FM- 23-5970-01



Kuhnt
FM- 23-5971-02



Desmarres
FM- 23-5972-03



Desmarres
FM- 23-5973-04



Paton
FM- 23-5974-12



Elsching
FM- 23-5975-13



Took
FM- 23-5976-12



Desmarres
FM- 23-5977-01



Desmarres
FM- 23-5978-02



Desmarres
FM- 23-5979-03



Gill
FM- 23-5980-12

EN	Calipers, Markers, Punches Chisels
DE	Messschieber, Marker, PUNCHES Meißel
ES	Pinzas, marcadores, cinceles Punzones
FR	Étriers, marqueurs, poinçons Burins
IT	Calibri, pennarelli, punzoni



Castroviejo
FM- 23-6036-15



Castroviejo
FM- 23-6037-20
20 mm



Holth
FM- 23-6038-01



Haitz
FM- 23-6039-02



West
FM- 23-6040-16
16 cm/6 1/4"



West
FM- 23-6041-16
16 cm/6 1/4"



Connin-Amsler
FM- 23-6042-13
13 cm/5"



Wilder
FM- 23-6043-01



Wilder
FM- 23-6044-02



Wilder
FM- 23-6045-03

Suture Forceps	EN
Suture Zange	DE
Pinzas de sutura	ES
Forceps de suture	FR
Pinza per sutura	IT

23



Tuebingen
FM- 23-6058-10
10 cm/4"



FM- 23-6059-08
8.5 cm/3 1/2"



Pau que
FM- 23-6060-10
10 cm/4"



Barraquer
FM- 23-6061-10
10.5 cm/4 1/4"



McPherson
FM- 23-6062-10
10 cm/4"



McPherson
FM- 23-6063-07
7.5 cm/3"

- EN Trochoma and Chalazion Forceps
- DE Trochoma und Chalazion Zange
- ES Trochoma y Chalazión Pinzas
- FR Trachome et pinces Chalazion
- IT Forcipe per tracoma e Chalazion



Knapp
FM- 23-6132-11
11 cm/4¼"



Ayer
FM- 23-6133-09
9 cm/3½"



Ayer
FM- 23-6134-09
9 cm/3½"



Lambert
FM- 23-6135-09
9 cm/3½"



Desmarres
9 cm/3½"



FM- 23-6136-01



FM- 23-6137-02



FM- 23-6138-03

Iridectomy Scissors **EN**
 Iridektomie Scissors **DE**
 Tijeras iridectomia **ES**
 Ciseaux d'iridectomie **FR**
 Iridectomia Forbici **IT**

23



Fig. 1



Fig. 2



Fig. 3



Noyes
 FM- 23-6140-12
 12 cm/4 3/4"



Wecker
 11.5 cm/4 1/2"



23-6141-01



FM- 23-6142-02



Barraquer
 FM- 23-6143-05
 5.5 cm/2 1/4"

Noyes
 Fig.1 FM- 23-6139-01
 Fig.2 FM- 23-6139-02
 Fig.3 FM- 23-6139-03
 12 cm/4 3/4"



FM- 23-6144-09
 9 cm/3 1/2"



FM- 23-6145-09



FM- 23-6146-09



FM- 23-6147-09



FM- 23-6148-09



FM- 23-6149-09

EN	Iridectomy Scissors
DE	Iridektomie Scissors
ES	Tijeras iridectomia
FR	Ciseaux d'iridectomie
IT	Iridectomia Forbici



Straight

Vannas
FM- 23-6150-08
8 cm/3 1/4"

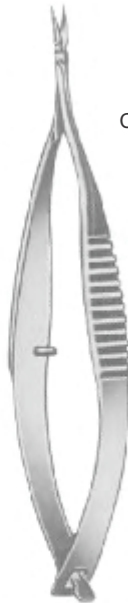

Curved

Vannas
FM- 23-6151-08
8 cm/3 1/4"

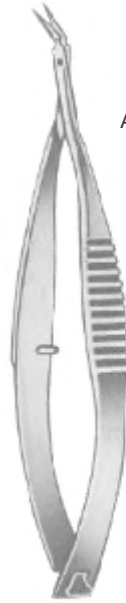

Angular

Vannas
FM- 23-6152-08
8 cm/3 1/4"

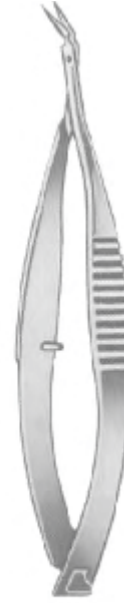

Vannas
FM- 23-6153-08
8 cm/3 1/4"



Straight

FM- 23-6154-08
8.5 cm/3 1/4"



Curved

FM- 23-6155-08
8.5 cm/3 1/4"



Angular

FM- 23-6156-08
8.5 cm/3 1/4"



Angular

FM- 23-6157-08
8.5 cm/3 1/4"

Vannas Mod, Tubingen

Iridectomy Scissors **EN**
 Iridektomie Scissors **DE**
 Tijeras iridectomia **ES**
 Ciseaux d'iridectomie **FR**
 Iridectomia Forbici **IT**

23



FAIZAN & MUSA
 SPECIAL INSTRUMENTS

OPHTHALMOLOGY



FM- 23-6158-10
10 cm/4"



FM- 23-6159-10
10 cm/4"



Castroviejo
FM- 23-6160-10
10 cm/4"



Castroviejo
FM- 23-6161-10
10 cm/4"



Aebli
FM- 23-6162-10
10 cm/4"



Castroviejo
FM- 23-6163-10
10 cm/4"



Castroviejo
FM- 23-6164-10
10 cm/4"



Troutman-Barraquer
FM- 23-6165-10
10 cm/4"



Troutman-Barraquer
FM- 23-6166-10
10 cm/4"



FAIZAN & MUSA
SPECIAL INSTRUMENTS

- EN** Gynecology
- DE** Gynäkologie
- ES** Ginecología
- FR** Gynécologie
- IT** Ginecologia

Page 316 to 328



EN	Vaginal Speculas
DE	Scheidenspekula
ES	Espéculos vaginales
FR	Spéculums vaginaux
IT	Specula vaginale



CUSCO
 FM- 24-6201-01 75 x 17mm
 FM- 24-6201-02 75 x 32mm
 FM- 24-6201-03 85 x 35mm
 FM- 24-6201-04 100 x 37mm

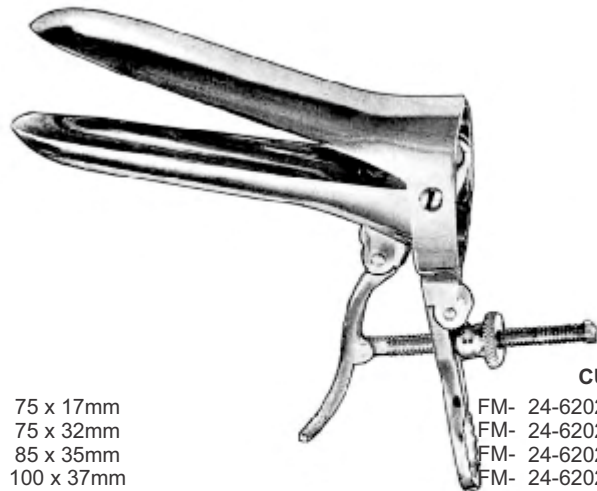

CUSCO
 FM- 24-6202-01 75 x 17mm
 FM- 24-6202-02 75 x 32mm
 FM- 24-6202-03 80 x 32mm
 FM- 24-6202-04 85 x 35mm
 FM- 24-6202-05 110 x 35mm
 FM- 24-6202-06 115 x 37mm



CUSCO
 FM- 24-6203-01 75 x 32mm
 FM- 24-6203-02 85 x 35mm
 FM- 24-6203-03 100 x 35mm
 FM- 24-6203-04 85 x 35mm (with cold light carrier)
 FM- 24-6203-05 (cold light carrier only)



CUSCO
 FM- 24-6204-01 75 x 17mm
 FM- 24-6204-02 85 x 17mm
 FM- 24-6204-03 100 x 17mm



CUSCO (Swiss pattern)
 FM- 24-6205-01 80 x 22mm
 FM- 24-6205-02 100 x 25mm
 FM- 24-6205-03 105 x 27mm
 FM- 24-6205-04 115 x 27mm



CUSCO'S
 FM- 24-6206-01 (LL)
 FM- 24-6206-02 (L)
 FM- 24-6206-03 (M)
 FM- 24-6206-04 (S)
 FM- 24-6206-05 (SS)
 FM- 24-6206-06 (SSS)



for children

COLLIN
 FM- 24-6207-01 55 x 10mm



COLLIN
 FM- 24-6207-02 65 x 20mm

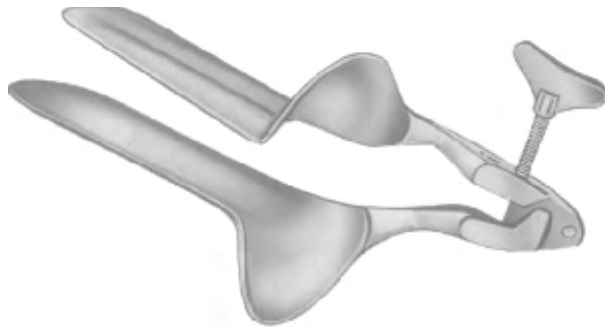

Collin-Landau
 Medium FM- 24-6207-03 35 x 100 mm



Collin
 Small FM- 24-6207-12 30 x 85 mm
 Medium FM- 24-6207-13 35 x 100 mm
 Large FM- 24-6207-14 40 x 110 mm

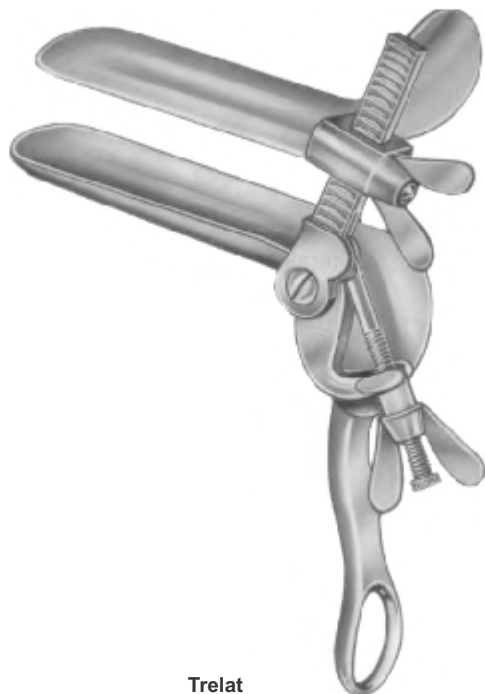

Trelat

	a mm	b mm
FM- 24-6208-01	85	33
FM- 24-6208-02	95	35
FM- 24-6208-03	115	43



Grave (Standard)

	a mm	b mm
FM- 24-6209-01	75	20
FM- 24-6209-02	95	35
FM- 24-6209-03	115	35
FM- 24-6209-04	125	35

EN	Vaginal Speculas
DE	Scheidenspekula
ES	Espéculos vaginales
FR	Spéculum vaginaux
IT	Specula vaginale



Pederson

	a	b
	mm	mm
FM- 24-6214-01	75	13
FM- 24-6214-02	100	22
FM- 24-6214-03	120	25
FM- 24-6214-04	130	25



Semm

	a	b
	mm	mm
FM- 24-6215-01	90	14/18
FM- 24-6215-02	100	17/20
FM- 24-6215-03	100	25/30

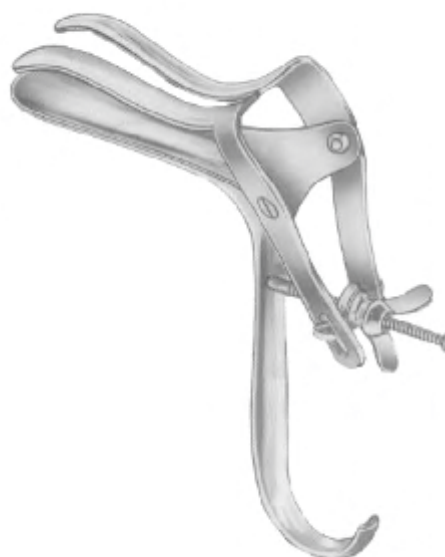

Nott

	a	b
	mm	mm
FM- 24-6216-01	90	30
FM- 24-6216-02	110	30

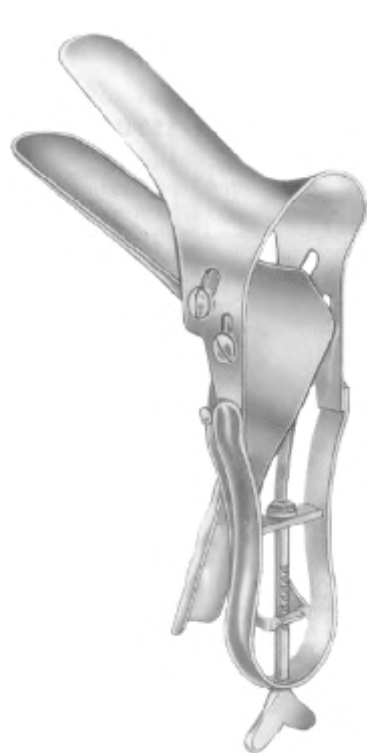

Seyffert

	a	b
	mm	mm
FM- 24-6217-01	100	17
FM- 24-6217-02	110	33



One Side open

Seyffert

	a	b
	mm	mm
FM- 24-6218-00	110	33



SAKURAI'S

FM- 24-6218-01 (LL)
FM- 24-6218-02 (L)
FM- 24-6218-03 (M)
FM- 24-6218-04 (S)



Sims (single ended)
 FM- 24-6219-01 63 x 32 mm
 FM- 24-6219-02 76 x 32 mm
 FM- 24-6219-03 89 x 38 mm



Sims (double ended)
 FM- 24-6220-01 65 x 25 mm (70 x 30 mm)
 FM- 24-6220-02 70 x 35 mm (70 x 35 mm)
 FM- 24-6220-03 85 x 35 mm (90 x 40 mm)
 FM- 24-6220-04 100 x 35 mm x 40 mm
 FM- 24-6220-05 120 x 35 mm x 40 mm



SIMS
 FM- 24-6220-11 60 x 25mm
 FM- 24-6220-12 70 x 30mm
 FM- 24-6220-13 80 x 35mm



Jackson

	Fig.	a	b
		mm	mm
FM- 24-6221-01	1	75 X	35
FM- 24-6221-02	2	90 X	35
FM- 24-6221-03	3	100 X	35
FM- 24-6221-04	4	75 X	40
FM- 24-6221-05	5	90 x	40
FM- 24-6221-06	6	100 x	40



Eastman

	Fig.	a	b
		mm	mm
FM- 24-6222-01	1	75 X	35
FM- 24-6222-02	2	90 X	35
FM- 24-6222-03	3	100 X	35
FM- 24-6222-04	4	75 X	40
FM- 24-6222-05	5	90 x	40
FM- 24-6222-06	6	100 x	40

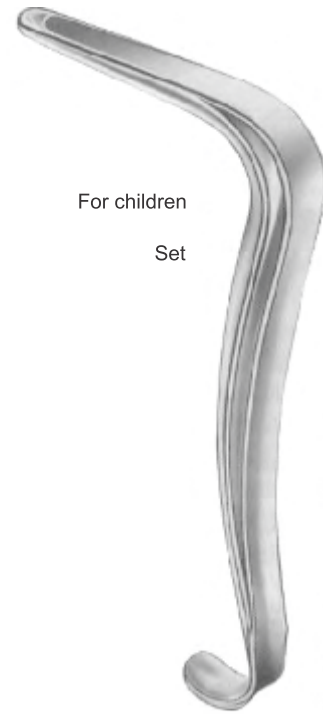

For children
Set

Kristeller
 FM- 24-6223-00
 70x15 mm

	a mm	b mm
FM- 24-6257-20	100	20
FM- 24-6257-25	100	25
FM- 24-6257-30	100	30
FM- 24-6257-35	100	35
FM- 24-6257-40	100	40
FM- 24-6258-20	130	20
FM- 24-6258-25	130	25
FM- 24-6258-30	130	30
FM- 24-6258-35	130	35
FM- 24-6258-40	130	40

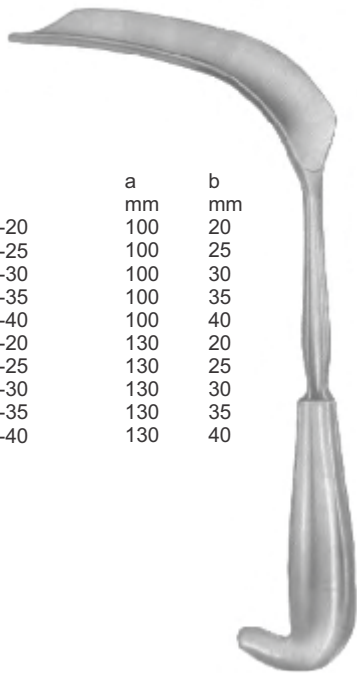

Matzenauer



Braun
FM- 24-6259-18
18 cm/7"
56x13 mm



Braun
FM- 24-6260-18
18 cm/7"
60x10 mm



Ulrich
FM- 24-6261-19
19.5 cm/7½"
80x20 mm



FM- 24-6262-19
19 cm/7½"
85x17 mm

Set

- FM- 24-6263-00
- FM- 24-6264-00

Fig. 1
Fig. 2

Specula

- FM- 24-6265-01
- FM- 24-6266-01

Fig.	a mm	b mm
1	70	40
2	90	40

Retractors

- FM- 24-6267-02
- FM- 24-6268-02

Fig.	a mm	b mm
1	70	33
2	90	33

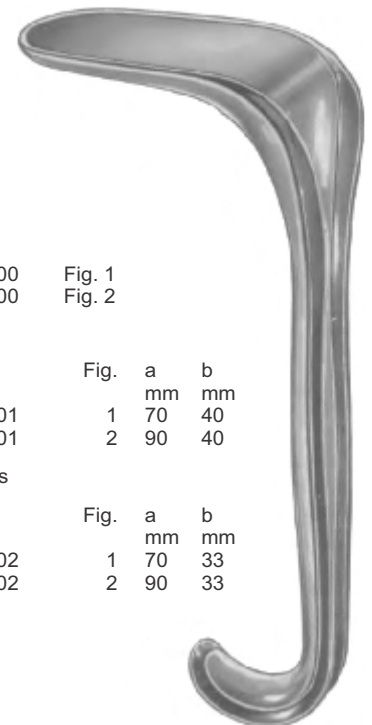

Kallmorgen

Vaginal Speculas EN
 Scheidenspekula DE
 Espéculos vaginales ES
 Spéculums vaginaux FR
 Specula vaginale IT

24



FAZAN & MUSA
 SURGICAL INSTRUMENTS

GYNECOLOGY

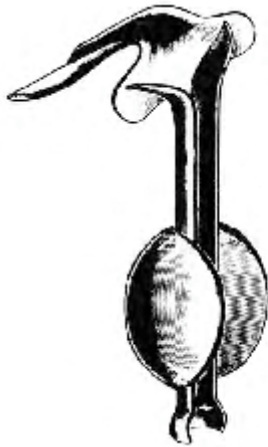

AUVARD

FM- 24-6282-01 80 x 38mm 2 lbs
 FM- 24-6282-02 80 x 38mm 2.5 lbs
 FM- 24-6282-03 80 x 38mm 3 lbs



AUVARD

FM- 24-6282-00
 68 x 40mm 3 lbs



80 x 38 mm

AUVARD

FM- 24-6282-04 2.5 lbs
 FM- 24-6282-05 3 lbs



Steiner-Auvard

FM- 24-6283-01 140 x 35mm 2.5 lbs
 FM- 24-6283-02 140 x 35mm 2.5 lbs
 laser pattern

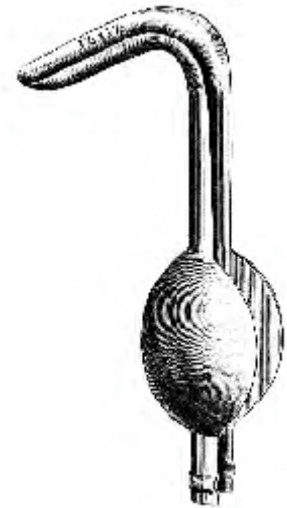

Henrotin

FM- 24-6283-03 80 x 35mm 3 lbs
 30° blade angled down



Landau

	a	b
	mm	mm
FM- 24-6284-01	105	28
FM- 24-6284-02	105	38

95 x 45 cm



Dunkel

FM- 24-6284-22



Breisky

	a	b
	mm	mm
FM- 24-6285-20	100	20
FM- 24-6285-25	100	25
FM- 24-6285-30	100	30
FM- 24-6285-35	100	35
FM- 24-6285-40	100	40
FM- 24-6286-20	130	20
FM- 24-6286-25	130	25
FM- 24-6286-30	130	30
FM- 24-6286-35	130	35
FM- 24-6286-40	130	40
FM- 24-6287-20	160	20
FM- 24-6287-25	160	25
FM- 24-6287-30	160	30
FM- 24-6287-35	160	35
FM- 24-6287-40	160	40
FM- 24-6288-20	180	20
FM- 24-6288-25	180	25
FM- 24-6288-30	180	30
FM- 24-6288-35	180	35
FM- 24-6288-40	180	40
FM- 24-6288-50	155	40

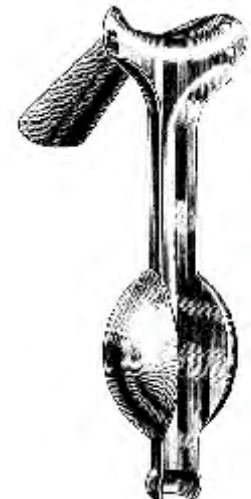

Berlind-Auvard
 FM- 24-6283-04
 105 x 40mm 2.5 lbs

EN	Uterine Dilators
DE	Uterus-Dilatatoren
ES	Dilatadores uterinos
FR	Dilatateurs utérins
IT	Dilatatori uterini



Hegar
single ended
18.5 cm long

mm Ø		mm dia.
1.0	FM- 24-6296-01	1.5
2.0	FM- 24-6296-02	2.5
3.0	FM- 24-6296-03	3.5
4.0	FM- 24-6296-04	4.5
5.0	FM- 24-6296-05	5.5
6.0	FM- 24-6296-06	6.5
7.0	FM- 24-6296-07	7.5
8.0	FM- 24-6296-08	8.5
9.0	FM- 24-6296-09	9.5
10.0	FM- 24-6296-10	10.5
11.0	FM- 24-6296-11	11.5
12.0	FM- 24-6296-12	12.5
13.0	FM- 24-6296-13	13.5
14.0	FM- 24-6296-14	14.5
15.0	FM- 24-6296-15	15.5
16.0	FM- 24-6296-16	16.5
17.0	FM- 24-6296-17	17.5
18.0	FM- 24-6296-18	18.5
19.0	FM- 24-6296-19	19.5
20.0	FM- 24-6296-20	20.5
21.0	FM- 24-6296-21	21.5
22.0	FM- 24-6296-22	22.5
23.0	FM- 24-6296-23	23.5
24.0	FM- 24-6296-24	24.5
25.0	FM- 24-6296-25	25.5
26.0	FM- 24-6296-26	26.5
27.0	FM- 24-6296-27	27.5
28.0	FM- 24-6296-28	28.5
29.0	FM- 24-6296-29	29.5
30.0	FM- 24-6296-30	30.5



Pieces per set

FM- 24-6297-10	14	4 - 17 mm
FM- 24-6297-20	26	1 - 26 mm
FM- 24-6297-30	30	1 - 30 mm

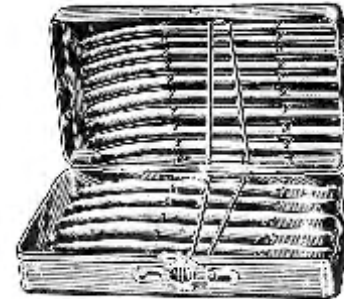

Pieces per set

FM- 24-6298-40	14	4 - 17 mm
FM- 24-6298-50	26	1 - 26 mm
FM- 24-6298-60	30	1 - 30 mm



Hegar
double ended
20 cm long

Ø mm	
1/2	FM- 24-6299-02
3/4	FM- 24-6299-04
5/6	FM- 24-6299-06
7/8	FM- 24-6299-08
9/10	FM- 24-6299-10
11/12	FM- 24-6299-12
13/14	FM- 24-6299-14
15/16	FM- 24-6299-16
17/18	FM- 24-6299-18
19/20	FM- 24-6299-20
21/22	FM- 24-6299-22
23/24	FM- 24-6299-24
25/26	FM- 24-6299-26

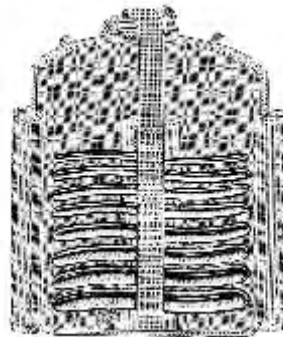

Pieces per set set

FM- 24-6300-00	08	3/4 - 17/18 mm	FM- 24-6300-30
FM- 24-6300-01	13	1/2 - 25/26 mm	FM- 24-6300-31

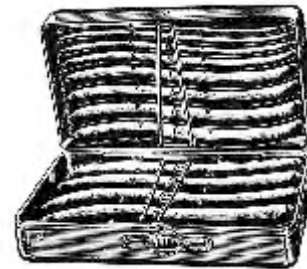

Uterine Dilators EN
 Uterus-Dilatatoren DE
 Dilataores uterinos ES
 Dilatateurs utérins FR
 Dilatatori uterini IT

24



- mm
- 3/6 FM- 24-6302-03
 - 4/7 FM- 24-6302-04
 - 5/8 FM- 24-6302-05
 - 6/9 FM- 24-6302-06
 - 7/10 FM- 24-6302-07
 - 8/11 FM- 24-6302-08
 - 9/12 FM- 24-6302-09
 - 10/13 FM- 24-6302-10
 - 11/14 FM- 24-6302-11
 - 12/15 FM- 24-6302-12
 - 13/16 FM- 24-6302-13
 - 14/17 FM- 24-6302-14
 - 15/18 FM- 24-6302-15
 - 16/19 FM- 24-6302-16
 - 17/20 FM- 24-6302-17
 - 18/21 FM- 24-6302-18

Hawkin Ambler

FM- 24-6301-12 Set of 12 3/6 - 14/17
 FM- 24-6301-16 Set of 16 3/6 - 18/21
 17 cm long



Hank
 FM- 24-6303-30

FM-

- mm
- 9/10 FM- 24-6304-10
 - 11/12 FM- 24-6304-12
 - 13/14 FM- 24-6304-14
 - 15/16 FM- 24-6304-16
 - 17/18 FM- 24-6304-18
 - 19/20 FM- 24-6304-20

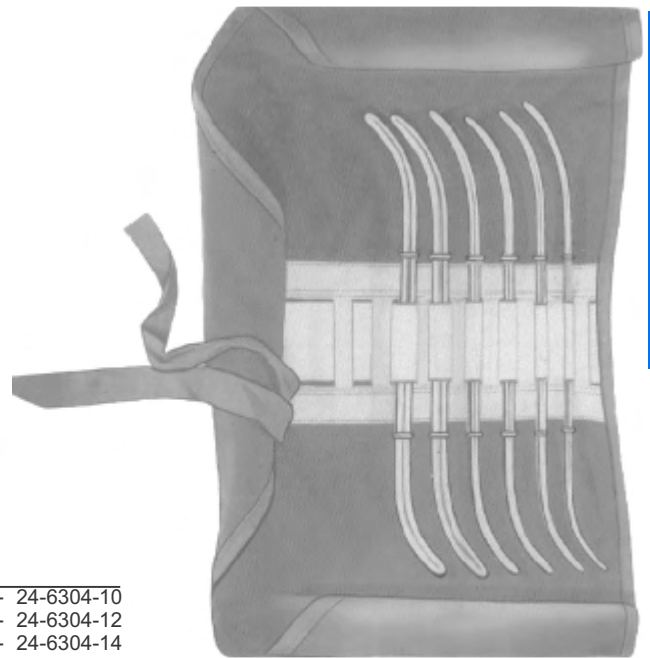

Set
 FM- 24-6305-00
 double ended
 27 cm



- mm
- 13/15 FM- 24-6306-15
 - 17/19 FM- 24-6306-19
 - 21/23 FM- 24-6306-23
 - 25/27 FM- 24-6306-27
 - 29/31 FM- 24-6306-31
 - 33/35 FM- 24-6306-35
 - 37/39 FM- 24-6306-39
 - 41/43 FM- 24-6306-43

Pratt

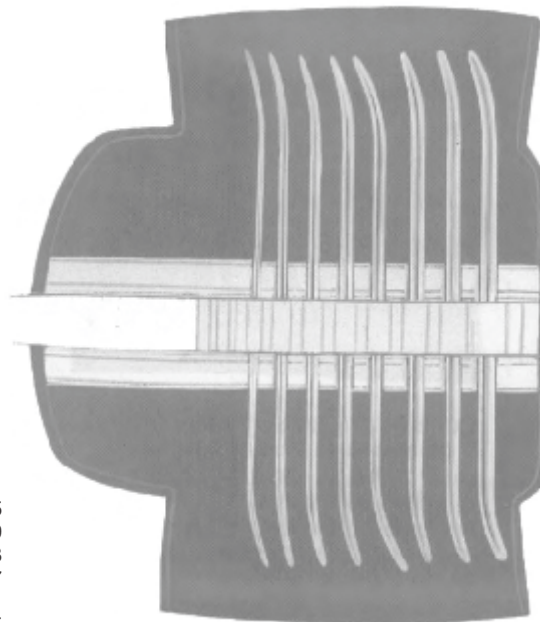

Set
 FM- 24-6306-00
 double ended
 29 cm



Jolly

- FM- 24-6307-00 set of 5
 FM- 24-6307-01 3-7 mm dia
 FM- 24-6307-02 5-9 mm dia
 FM- 24-6307-03 7-12 mm dia
 FM- 24-6307-04 9-15 mm dia
 FM- 24-6307-05 12-18 mm dia

EN Corn Knives, Fistula Hooks, Myoma Instruments
DE Konusmesser, Fistelhaken, Myom-instrumente
ES Bisturí p. conos de atraccion, Ganchos p. fistulas
FR Couteaux de maïs, Fistula Hooks, Myoma Instruments
IT Coltelli per mais, ganci per stola, strumenti per mioma



Ayre
 FM- 24-6328-23
 23 cm/9"



Simon
 FM- 24-6329-22
 22 cm/8¾"



Simon
 FM- 24-6330-22
 22 cm/8¾"



Emmet
 22 cm/8¾"



FM- 24-6331-01



FM- 24-6331-02



FM- 24-6331-03



FM- 24-6331-04

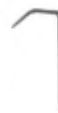

FM- 24-6331-05



FM- 24-6332-24
 24.0cm



Doyen
 FM- 24-6332-17 T-Handle
 FM- 24-6332-18 Loop-Handle
 17 cm/6¾"



Doyen
 FM- 24-6333-17 T-Handle
 FM- 24-6333-18 Loop-Handle
 17 cm/6¾"



Segond
 FM- 24-6334-27
 27 cm/10½"

Suction Biopsy Currettes **EN**

Saug- und Biopsieküretten **DE**

Curetas aspiradoras para biopsia **ES**

Curettes de biopsie d'aspiration **FR**

Curette per biopsia di aspirazione **IT**

24



FAIZAN & MUSA
SPECIAL INSTRUMENTS

GYNECOLOGY



Kevorkian malleable
FM- 24-6340-30 30 cm/12"
FM- 24-6341-30 30 cm/12"



Kevorkian malleable
FM- 24-6342-30 30 cm/12"
FM- 24-6343-30 30 cm/12"



Townsend malleable
FM- 24-6344-30 31 cm/12¼"
FM- 24-6345-30 31 cm/12¼"



Duncan
FM- 24-6346-31 31 cm/12¼"



Duncan
FM- 24-6347-31 31 cm/12¼"

- EN Cervical Biopsy and Specimen Forceps
- DE Probeexzisionszangen
- ES Pinzas saca-bocados para biopsia
- FR Biopsie cervicale et forceps de spécimen
- IT Pinza per biopsia cervicale e campione

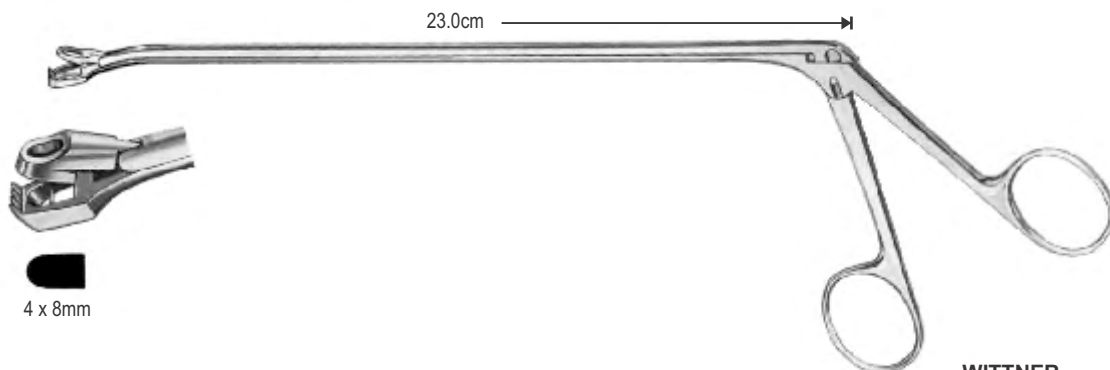

WITTNER

- FM- 24-6409-23 23.0cm (straight)
- FM- 24-6410-23 23.0cm (angled)



ALEXANDER

- FM- 24-6411-28 28.0cm

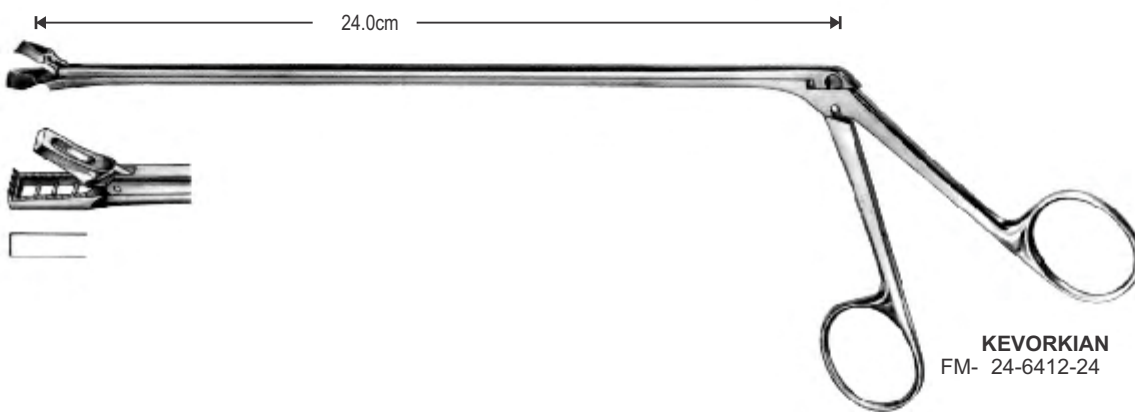

KEVORKIAN

- FM- 24-6412-24

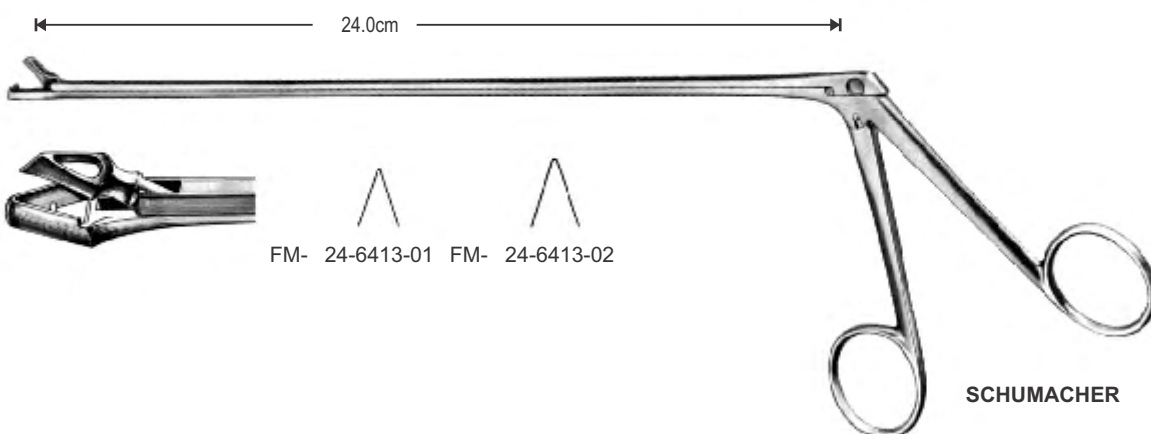

SCHUMACHER

Uterine Scoops **EN**
 Uterusloffel **DE**
 Cucharillas uterinas **ES**
 Scoops utérins **FR**
 Scoop Uterine **IT**

24



GYNECOLOGY



SIMON
25.0cm, sharp, rigid



SCHROEDER
30.0cm, sharp, rigid

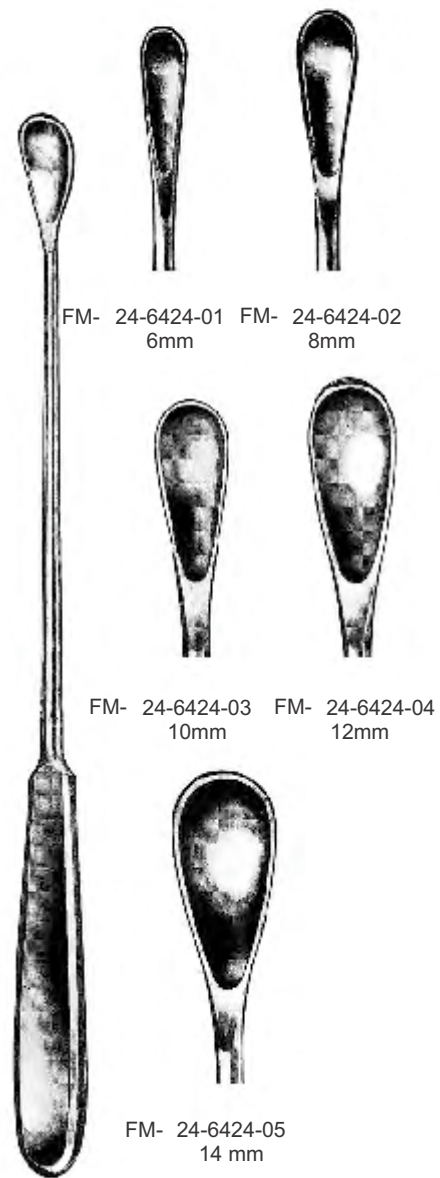

GOURDET
28.0cm, blunt

EN	Suction Biopsy Curettes
DE	Saug und Biopsiekuretten
ES	Curetas aspiradores para biopsia
FR	Curettes de biopsie d'aspiration
IT	Curette per biopsia di aspirazione

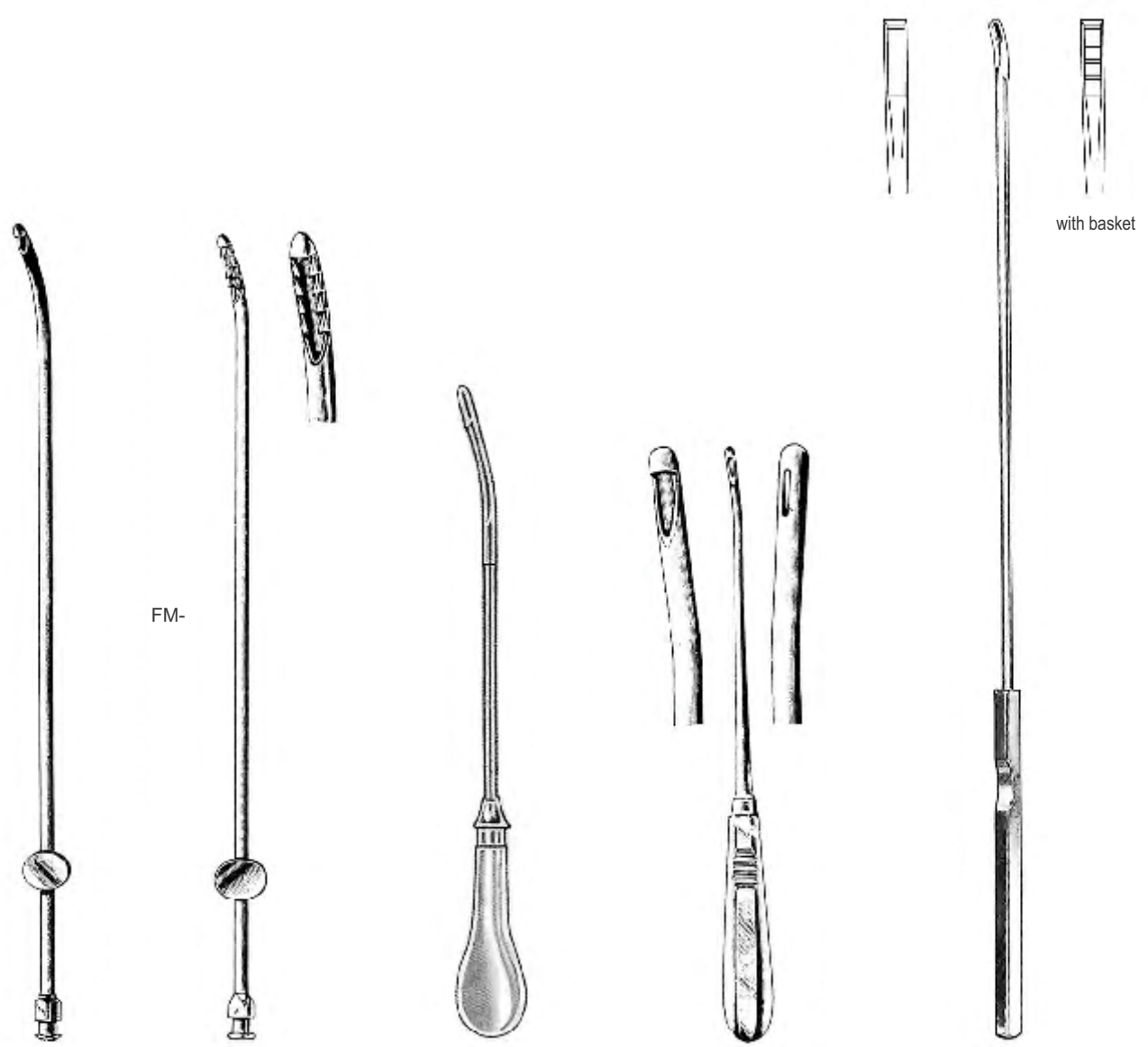

RANDALL 24.0cm	NOVAK 23.0cm	SHERMAN 23.0cm	MUENCHEN 27.0cm	KEVORKIAN 30.0cm
1mm dia. FM- 24-6453-01	FM- 24-6454-01	FM- 24-6455-23 3.5mm dia.	FM- 24-6456-27	FM- 24-6457-12 1.2mm 24-6458-12
2mm dia. FM- 24-6453-02	FM- 24-6454-02			FM- 24-6457-40 4.0mm 24-6458-40
3mm dia. FM- 24-6453-03	FM- 24-6454-03			
4mm dia. FM- 24-6453-04	FM- 24-6454-04			

- EN** Obstetrics
- DE** Geburtshilfe
- ES** Obstetricia
- FR** Obstétrique
- IT** Ostetricia

Page 329 to 336



EN	Obstetrical Forceps
DE	Geburtszangen
ES	Forceps obstetricos
FR	Forceps obstétriques
IT	Pinza ostetrica

OBSTETRICS



WRIGLEY
FM- 25-6501-23 23.0cm
FM- 25-6501-28 28.0cm



DE-LEE
FM- 25-6502-30 30.0cm



DE-LEE
FM- 25-6503-36 36.0cm



SIMPSON
FM- 25-6504-23 23.0cm, str.
FM- 25-6505-23 23.0cm, cvd.



SIMPSON
FM- 25-6506-23 23.0cm
FM- 25-6506-30 30.0cm



SIMPSON-BRAUN
FM- 25-6507-33 33.0cm
FM- 25-6507-36 36.0cm



KIELLAND
FM- 25-6508-41 41.0cm



PIPER
FM- 25-6509-44 44.0cm



ELLIOT
 FM- 25-6510-32 32.0cm
 FM- 25-6510-38 38.0cm



NAEGELE
 FM- 25-6511-36 36.0cm
 FM- 25-6511-40 40.0cm



KEDAR NATH DAS
 FM- 25-6512-33 33.0cm



BOERMA
 FM- 25-6513-29 29.0cm



LAUFE-PIPER
 FM- 25-6514-30 30.0cm

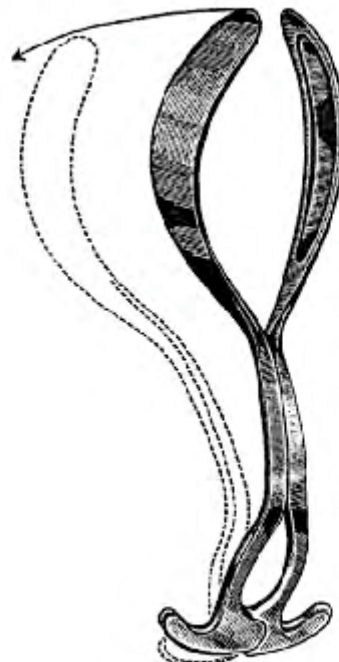

LAUFE DIVERGENT OUTLET
 FM- 25-6515-31 31.0cm

- EN Uterine Haemostasis Forceps and Umbilical Cord Clamps
- DE Uterus-Klemmzange und Nabelschnurklemmen
- ES Pinzas uterinas p/hemostasis y clamps umbilicales
- FR Pincés hémostatiques utérines et clamps de cordon ombilical
- IT Pinze emostatiche uterine e pinze ombelicali



GREEN-ARMYTAGE
FM- 25-6542-21
21.0cm



GREEN-ARMYTAGE
FM- 25-6543-19
19.5cm



GAUSS
FM- 25-6544-26
26.0cm

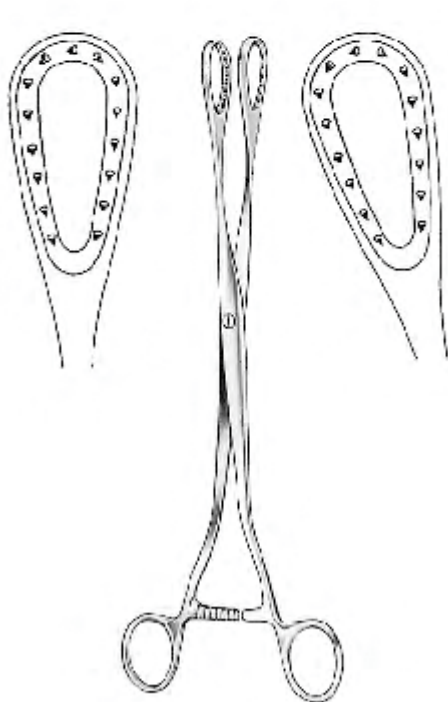

SAENGER
FM- 25-6545-27 27.0cm 25-6546-27



SELLHEIM
FM- 25-6547-28
28.0cm



KANE
FM- 25-6548-08
8.5cm



COLLIN
FM- 25-6549-09
9.0cm

Placenta and Ovum forceps EN

Plazenter-und-Abortuszangen DE

Pinzas para aboroto y placenta ES

Pince à placenta et Ovum FR

Pinza per placenta e ovulo IT

25



FAIZAN & MUSA
SPECIAL INSTRUMENTS

OBSTETRICS



HEYWOOD-SMITH
FM- 25-6550-25
25.0cm



COREY
FM- 25-6551-24
24.0cm



WILLET
FM- 25-6552-19
19.0cm

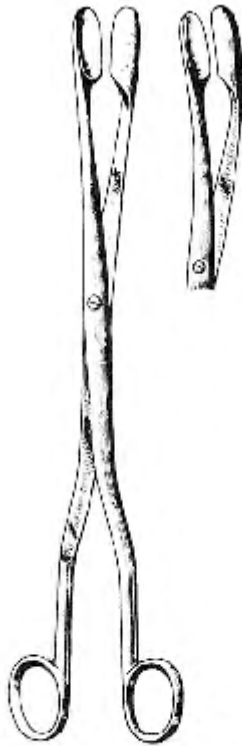

WINTER
28.0cm

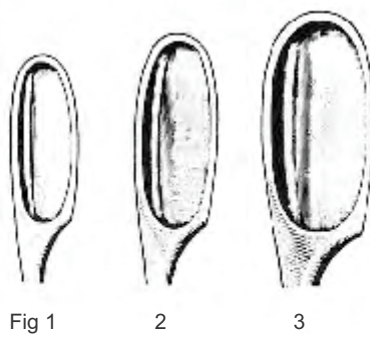
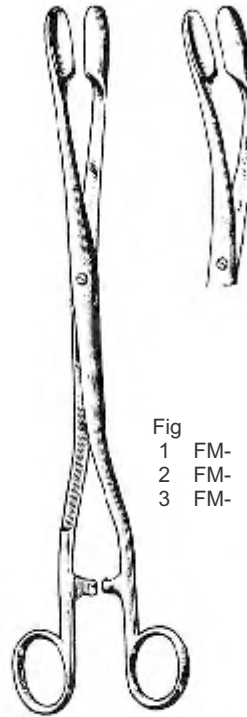

Fig 1

2

3

Fig	str	cur
1	FM- 25-6553-01	25-6554-01
2	FM- 25-6553-02	25-6554-02
3	FM- 25-6553-03	25-6554-03



WINTER-NASSAUER
28.0cm

Fig	str	cur
1	FM- 25-6555-01	25-6556-01
2	FM- 25-6555-02	25-6556-02
3	FM- 25-6555-03	25-6556-03

Ovum Curettes, Abortion Scoops **EN**
 Abortuskuretten und loffel **DE**
 Curetas y cucharillas para aborto **ES**
 Curettes d'ovule, boules d'avortement **FR**
 Curette di Ovum, Scoop d'aborto **IT**

25



OBSTETRICS

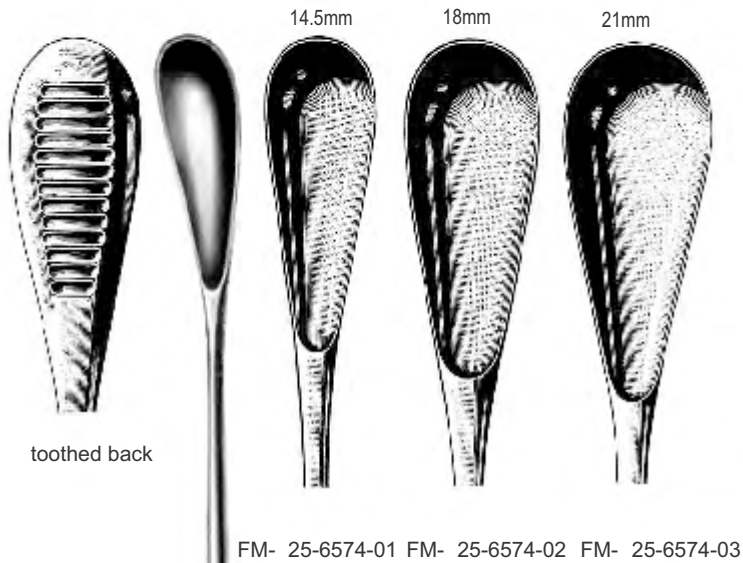

CUZZI
30.0cm, blunt



PESTALOZZA
30.0cm

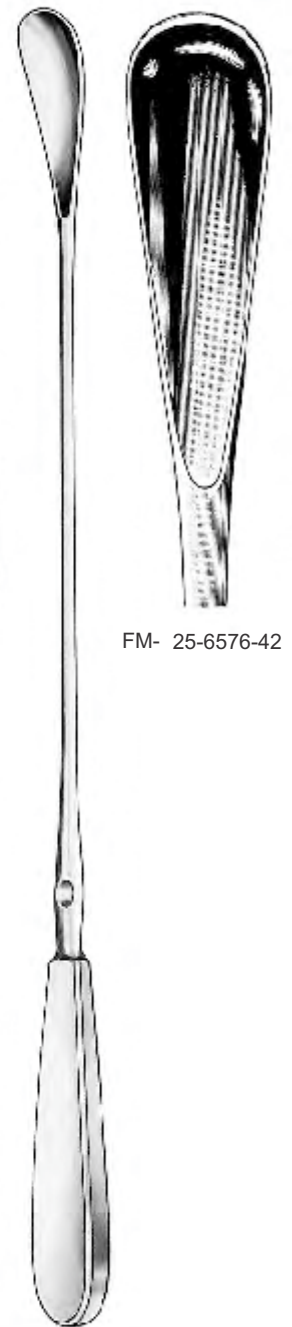

WALLICH
42.0cm, blunt

EN	Intra-Uterine Cannula
DE	Intrauterine Kanülen
ES	Canulas intrauterino
FR	Canule intra-utérine
IT	Cannula intrauterina



FAIZAN & MUSA
SPECIAL INSTRUMENTS



SPACKMANN
FM- 25-6571-35
35.0cm

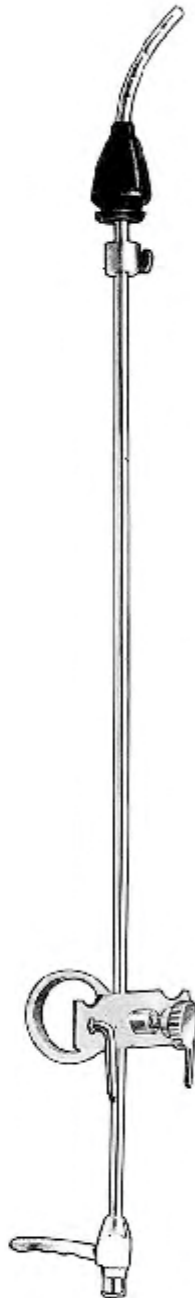

SPACKMANN
FM- 25-6572-35
35.0cm



LEECH-WILKINSON
26.5cm



FM- 25-6573-01
Ø 10 x 25mm
small



FM- 25-6573-02
Ø 13 x 30mm
medium



FM- 25-6573-03
Ø 16 x 30mm
large

OBSTETRICS



FM- 25-6577-03 3 mm Ø FM- 25-6578-04 4,5 mm Ø FM- 25-6579-06 6 mm Ø FM- 25-6580-08 8 mm Ø FM- 25-6581-10 10 mm Ø FM- 25-6582-12 12 mm Ø FM- 25-6583-14 14 mm Ø FM- 25-6584-50

Pelvimeters	EN
Beckenzirkel	DE
Pelvimetros	ES
pelvimètres	FR
Pelvimeters	IT



COLLYER
FM- 25-6595-33 33.0cm
cm / inch scale



DELEE
FM- 25-6596-20 20.0cm
cm / inch scale



MARTIN
FM- 25-6597-34 34.0cm
FM- 25-6598-34 34.0cm
cm / inch scale



COLLIN
FM- 25-6599-35
35.0cm
cm scale

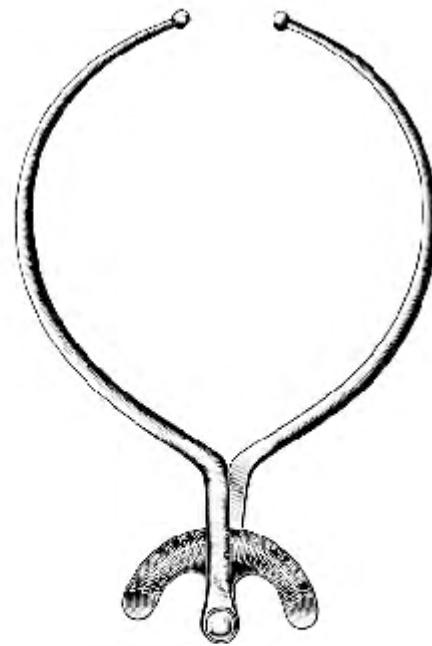

BREISKY
FM- 25-6600-33
33.0cm
cm / inch scale

- EN** Goitre
- DE** Kropfchirurgie
- ES** Bocio
- FR** Goitre
- IT** Gozzo

Page 337



EN Goitre Enucleator, Goitre Grasping Forceps
 DE Kropfsonden, Kropfasszangen
 ES Sondas para bocio, Pinzas para coger el bocio
 FR Goitre Enucleator, Forceps Goitre Grasping
 IT Goitre Enucleator, Pinza da presa del gozzo

GOITRE

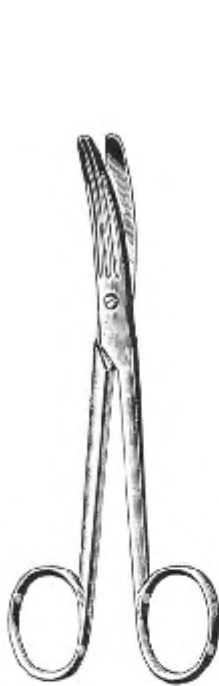

SCHOEMAKER
 FM- 26-6701-15
 15.0cm

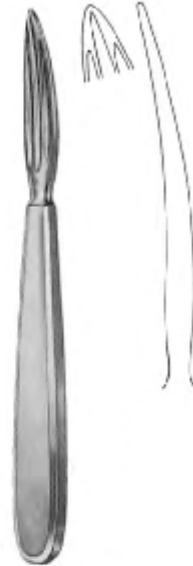

KOCHER
 FM- 26-6702-15 15.0cm
 FM- 26-6702-16 16.0cm

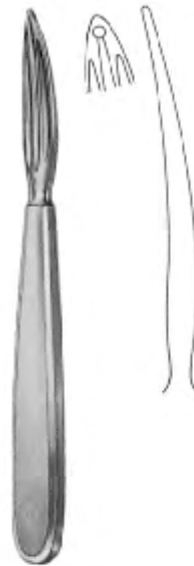

KOCHER
 FM- 26-6703-15
 FM- 26-6703-16



KOCHER
 FM- 26-6704-18
 18.0cm



HOFMEISTER
 FM- 26-6705-21
 21.0cm



LAHEY
 FM- 26-6706-15 15.0cm
 FM- 26-6706-20 20.0cm



MASTIN
 FM- 26-6707-17
 17.0cm

- EN** Sterilization
- DE** Sterilisation
- ES** Esterilización
- FR** Stérilisation
- IT** Sterilizzazione

Page 338



EN Sterilizing Forceps

DE Sterilisierzangen

ES Pinzas para esterilización

FR Forceps de stérilisation

IT Forcipe sterilizzante

FAIZAN & MUSA
SPECIAL INSTRUMENTS

CHEATLE
FM- 27-6801-27
27.0cm



CHEATLE
FM- 27-6802-26
26.5cm



CHEATLE
FM- 27-6803-28
28.0cm



FM- 27-6804-20 20.0cm
FM- 27-6804-30 30.0cm



ROGGE
FM- 27-6805-23
23.0cm



DAVIS
FM- 27-6806-16 16.0cm
FM- 27-6806-20 20.0cm
FM- 27-6806-24 24.0cm

EN	Asepsis
DE	Asepsis
ES	Asepsia
FR	Asepsie
IT	Asepsi

Page 339 to 340



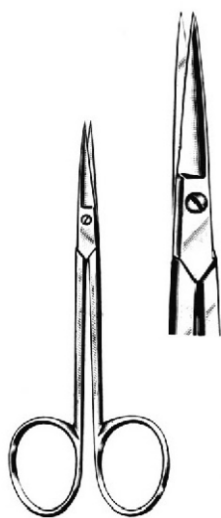

FM- 28-6901-10 10.5 cm/4"

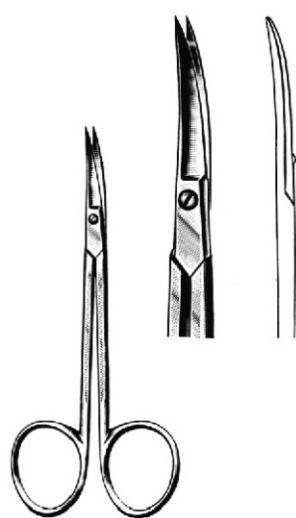

FM- 28-6902-10 10.5 cm/4"



FM- 28-6903-10 10.5 cm/4"

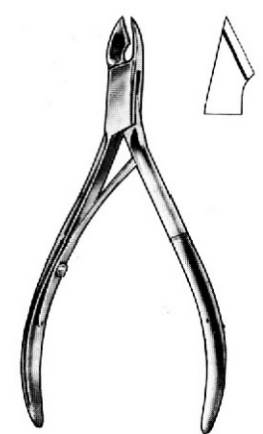

FM- 28-6904-10 10.5 cm/4"
 FM- 28-6904-11 11.5 cm/4 1/2"
 FM- 28-6904-13 13 cm/5"



FM- 28-6905-10 10.5 cm/4"
 FM- 28-6905-11 11.5 cm/4 1/2"
 FM- 28-6905-13 13 cm/5"
 FM- 28-6905-15 15 cm/6"

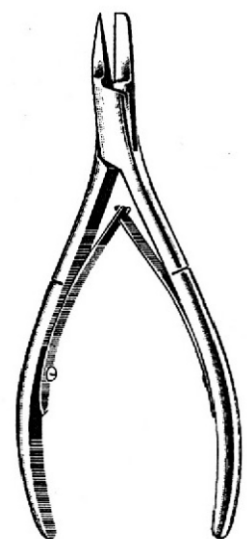

**INGROWN TOE NAIL FORCEPS
 ENGLISH (ANVIL) PATTERN**
 FM- 28-6906-12 12.5 cm/5"

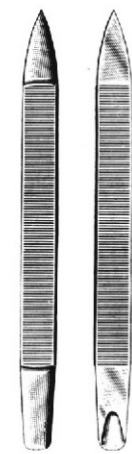

FM- 28-6907-10 10 cm/4"
 FM- 28-6907-12 12 cm/5"



FM- 28-6908-16 16 cm/6 1/2"

Nail Scissors, Nippers **EN**

Nagelscheren, Nagelzangen **DE**

Tijeras para ungas, pinzas corta-ungas **ES**

Ciseaux à ongles, pinces **FR**

Forbici per unghie, tronchesi **IT**

28



FAIZAN & MUSA
SPECIAL SURGICAL

ASEPSIS



FM- 28-6909-09 9 cm/3 1/2" FM- 28-6910-09
FM- 28-6909-10 10 cm/4" FM- 28-6910-10
FM- 28-6909-11 11 cm/4 1/2" FM- 28-6910-11



FM- 28-6911-12 12 cm/5"
FM- 28-6911-13 13 cm/5 1/4"



FM- 28-6912-14
14 cm/5 1/2"

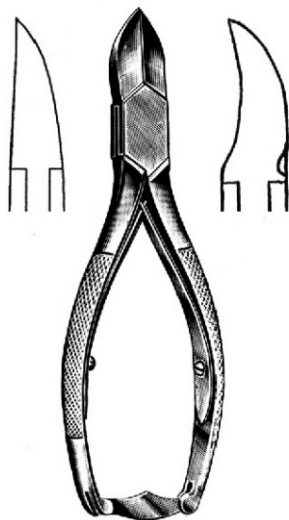

FM- 28-6914-14 14 cm/5 1/2"
FM- 28-6914-16 16 cm/6 1/2"



TURNBULL
FM- 28-6915-11 11 cm/4 1/2"
FM- 28-6915-13 13 cm/5"

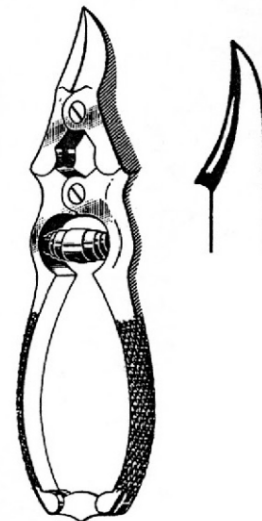

**NAIL NIPPER
Double Action**
FM- 28-6916-15
15 cm/6"

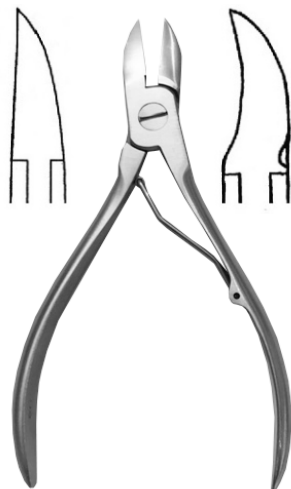

FM- 28-6917-12 12 cm/5" FM- 28-6918-12
FM- 28-6917-13 13 cm/5 1/2" FM- 28-6918-13



FM- 28-6919-15
S/E



FM- 28-6920-15
D/E

EN	Hollowware
DE	Hollowware
ES	Hollowware
FR	Hollowware
IT	cavo

Page 341 to 348



EN Needle Case, Endodontic Box, Tube Rack, Cotton Holder,
DE Needle Case, Endodontie Box, Tube Rack, Cotton Holder
ES Caso aguja, Caja de endodoncia, bastidor de tubo
FR Cas d'aiguille, boîte endodontique, support de tube, support de coton
IT Astuccio per aghi, scatola endodontica, portaprovette, porta cotone

HOLLOWWARE



Needle Case Round with Cover
 FM- 29-7001-01 65x15mm



Needle Case Round
 FM- 29-7002-01 80x20mm



Needle Case Rectangle
 FM- 29-7003-01 70x70x10mm



Endodontic Box
 FM- 29-7004-01
 100x40x50mm

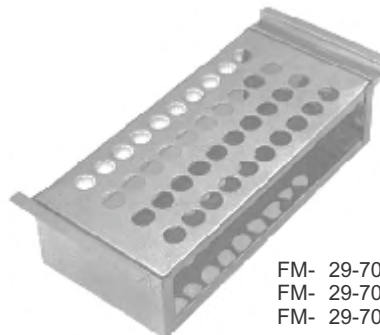

FM- 29-7005-01 6.35x15.25x5cm for 12 tubes
 FM- 29-7005-02 6.35x17.75x7.5cm for 27 tubes
 FM- 29-7005-03 7.50x17.75x6.35cm for 36 tubes

Tube Rack



Sprit Lamp
 FM- 29-7006-01
 Standard Size



Sprit Lamp
 FM- 29-7007-01
 Standard Size



Sputum Cup
 FM- 29-7008-01 75x80mm
 FM- 29-7008-02 100x50mm
 FM- 29-7008-03 100x80mm

Jars, Jallipot, Bowls, Cups EN

Jars, Jallipot, Schalen, Becher DE

Frascos, Jallipot, tazones, tazas ES

Pots, jallipot, bols, tasses FR

Barattoli, Jallipot, ciotole, tazze IT

29



FAIZAN & MUSA
SPECIAL PATENTED



Dressing Jar

- FM- 29-7009-01 80x60mm FM- 29-7010-01
- FM- 29-7009-02 80x80mm FM- 29-7010-02
- FM- 29-7009-03 100x100mm FM- 29-7010-03
- FM- 29-7009-04 120x120mm FM- 29-7010-04
- FM- 29-7009-05 150x150mm FM- 29-7010-05
- FM- 29-7009-06 180x180mm FM- 29-7010-06
- FM- 29-7009-07 200x200mm FM- 29-7010-07



Dressing Jar



Fennle

- FM- 29-7012-01 100mm Ø
- FM- 29-7012-02 120mm Ø
- FM- 29-7012-03 150mm Ø
- FM- 29-7012-04 200mm Ø



Cotton Holder
FM- 29-7011-01



Cotton Holder
FM- 29-7011-02

FM-



Forceps Jar

- FM- 29-7013-01 30x90mm
- FM- 29-7013-02 50x125mm
- FM- 29-7013-03 50x170mm
- FM- 29-7013-04 50x200mm
- FM- 29-7013-05 40x230mm
- FM- 29-7013-06 70x110mm
- FM- 29-7013-07 80x150mm
- FM- 29-7013-08 100x200mm
- FM- 29-7013-09 150x30mm



Gallipot

- FM- 29-7014-01 01 oz FM- 29-7014-09 09 oz
- FM- 29-7014-02 02 oz FM- 29-7014-10 10 oz
- FM- 29-7014-03 03 oz FM- 29-7014-11 11 oz
- FM- 29-7014-04 04 oz FM- 29-7014-12 12 oz
- FM- 29-7014-05 05 oz FM- 29-7014-13 13 oz
- FM- 29-7014-06 06 oz FM- 29-7014-14 14 oz
- FM- 29-7014-07 07 oz FM- 29-7014-15 15 oz
- FM- 29-7014-08 08 oz FM- 29-7014-16 16 oz



Spong Bowl

- FM- 29-7015-01 12 cm
- FM- 29-7015-02 15 cm
- FM- 29-7015-03 20 cm

HOLLOWWARE

EN	Cup, Bowl, Kedney Trays
DE	Cup, Schüssel, Nierenschalen
ES	Copa, Bowl, bandejas de riñón
FR	Coupe, bol, plateaux de Kedney
IT	Coppa, ciotola, Kedney Vassoio



HOLLOWWARE



Medicine Cup
 FM- 29-7016-01 50ml
 FM- 29-7016-02 60ml
 FM- 29-7016-03 70ml



Lotion Bowl without spout

FM- 29-7017-01 40x19mm	FM- 29-7017-08 150x65mm
FM- 29-7017-02 50x25mm	FM- 29-7017-09 180x85mm
FM- 29-7017-03 60x30mm	FM- 29-7017-10 200x100mm
FM- 29-7017-04 80x40mm	FM- 29-7017-11 250x120mm
FM- 29-7017-05 100x50mm	FM- 29-7017-12 300mm
FM- 29-7017-06 120x60mm	FM- 29-7017-13 350mm
FM- 29-7017-07 140x60mm	FM- 29-7017-14 400mm



Wash Basin
 FM- 29-7018-01 300x80mm
 FM- 29-7018-02 320x85mm
 FM- 29-7018-03 330x90mm
 FM- 29-7018-04 350x110mm
 FM- 29-7018-05 400x115mm



Kick Bucket with Trolley
 FM- 29-7019-01
 390x280x180mm



Kidney Tray Shallow
 FM- 29-7020-01 17cm
 FM- 29-7020-02 22cm
 FM- 29-7020-03 24cm



Kidney Tray
 FM- 29-7021-01 12cm
 FM- 29-7021-02 15cm
 FM- 29-7021-03 18cm
 FM- 29-7021-04 20cm
 FM- 29-7021-05 25cm
 FM- 29-7021-06 28cm
 FM- 29-7021-07 30cm



Kidney Tray (with cover)
 FM- 29-7022-01 15cm
 FM- 29-7022-02 20cm
 FM- 29-7022-03 25cm
 FM- 29-7022-04 30cm

FMM-

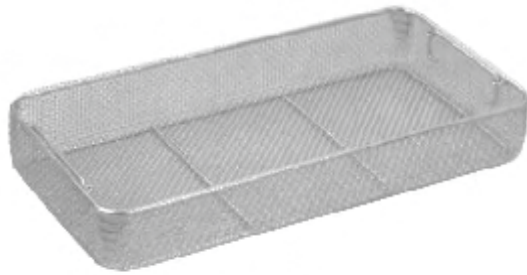

Wire Mesh Tray

- FM- 29-7023-01 240x250x5mm
- FM- 29-7023-02 480x250x5mm
- FM- 29-7023-03 550x250x5mm
- FM- 29-7023-04 240x250x7mm
- FM- 29-7023-05 480x250x7mm
- FM- 29-7023-06 240x250x10mm
- FM- 29-7023-07 480x250x10mm



Wire Mesh Tray with Lid

- FM- 29-7024-01 240x250x5mm
- FM- 29-7024-02 480x250x5mm
- FM- 29-7024-03 550x250x5mm
- FM- 29-7024-04 240x250x7mm
- FM- 29-7024-05 480x250x7mm
- FM- 29-7024-06 240x250x10mm
- FM- 29-7024-07 480x250x10mm



Perforated Tray

- FM- 29-7025-01 200x100x40mm
- FM- 29-7025-02 250x120x50mm
- FM- 29-7025-03 300x150x50mm
- FM- 29-7025-04 350x170x50mm
- FM- 29-7025-05 400x200x50mm



Instruments Tray without Lid

- FM- 29-7026-01 100x150x25mm
- FM- 29-7026-02 150x200x40mm
- FM- 29-7026-03 200x250x45mm
- FM- 29-7026-04 250x300x50mm
- FM- 29-7026-05 300x350x50mm
- FM- 29-7026-06 150x300x50mm
- FM- 29-7026-07 200x300x50mm
- FM- 29-7026-08 230x150x50mm



Instruments Tray with Lid

- FM- 29-7027-01 100x150x25mm
- FM- 29-7027-02 150x200x40mm
- FM- 29-7027-03 200x250x45mm
- FM- 29-7027-04 250x300x50mm
- FM- 29-7027-05 300x350x50mm
- FM- 29-7027-06 150x300x50mm
- FM- 29-7027-07 200x300x50mm
- FM- 29-7027-08 230x150x50mm

- EN Instruments Tray, Instruments Boxes
- DE Instrumente Tray, Instrumente Boxen
- ES Bandeja instrumentos, Instrumentos Cajas
- FR Forceps Grasping
- IT Plateau à instruments, boîtes à instruments



HOLLOWWARE



Burr Tray
FM- 29-7028-01
190x100x20mm

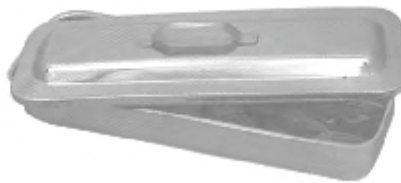

Cathetes Tray with Lid
FM- 29-7029-01 300x80x40mm
FM- 29-7029-02 350x90x45mm
FM- 29-7029-03 400x100x50mm

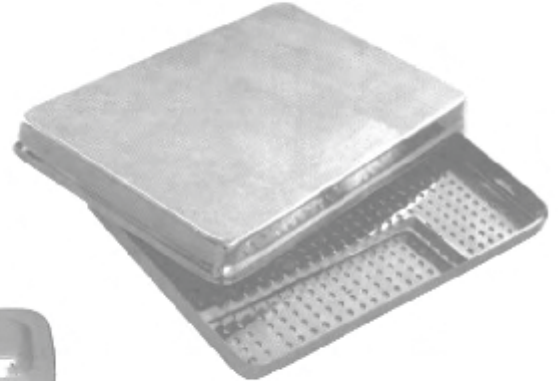

Scaler Tray with cover
FM- 29-7030-01
200x100x16mm



Instruments Box with Hooks

- FM- 29-7031-01 170x70x30mm
- FM- 29-7031-02 180x80x40mm
- FM- 29-7031-03 200x100x40mm
- FM- 29-7031-04 230x120x50mm
- FM- 29-7031-05 250x125x50mm
- FM- 29-7031-06 300x150x50mm
- FM- 29-7031-07 350x170x50mm
- FM- 29-7031-08 400x200x90mm
- FM- 29-7031-09 500x200x120mm



Instruments Box

- FM- 29-7032-01 170x70x30mm
- FM- 29-7032-02 180x80x40mm
- FM- 29-7032-03 200x100x40mm
- FM- 29-7032-04 230x120x50mm
- FM- 29-7032-05 250x125x50mm
- FM- 29-7032-06 300x150x50mm
- FM- 29-7032-07 350x170x50mm
- FM- 29-7032-08 400x200x90mm
- FM- 29-7032-09 500x200x120mm

Instruments Box, Sterilization Box	EN
Instrumente Box, Sterilisation Box	DE
Instrumentos de pelo, caja de esterilización	ES
Pinces à dissection	FR
Pinze per dissezione	IT

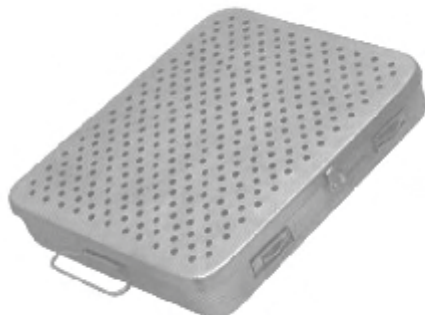

**Instruments Box
Perforated**

- FM- 29-7033-01 200x100x40mm
- FM- 29-7033-02 250x150x40mm
- FM- 29-7033-03 300x150x40mm



Electric Sterilizer

- FM- 29-7034-01 200x100x120mm
- FM- 29-7034-02 250x120x140mm
- FM- 29-7034-03 300x150x150mm
- FM- 29-7034-04 350x170x170mm
- FM- 29-7034-05 400x200x180mm
- FM- 29-7034-06 450x230x190mm

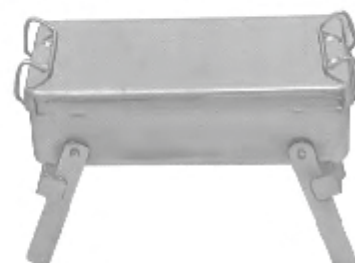

Non Electric Sterilizer

- FM- 29-7035-01 200x100x65mm
- FM- 29-7035-02 250x125x65mm
- FM- 29-7035-03 300x150x100mm
- FM- 29-7035-04 350x170x65mm
- FM- 29-7035-05 400x200x100mm

HOLLOWWARE



Electric Sterilizer
FM- 29-7036-01
280x125x65mm

- FM- 29-7037-01 125x80mm
- FM- 29-7037-02 125x120mm
- FM- 29-7037-03 150x100mm
- FM- 29-7037-04 150x150mm
- FM- 29-7037-05 180x180mm
- FM- 29-7037-06 190x140mm
- FM- 29-7037-07 190x190mm
- FM- 29-7037-08 200x200mm
- FM- 29-7037-09 240x120mm
- FM- 29-7037-10 240x240mm
- FM- 29-7037-11 290x140mm
- FM- 29-7037-12 290x240mm
- FM- 29-7037-13 290x290mm
- FM- 29-7037-14 340x160mm
- FM- 29-7037-15 340x340mm
- FM- 29-7037-16 390x150mm
- FM- 29-7037-17 390x200mm
- FM- 29-7037-18 390x290mm



Sterilizer Drum

EN	Bedpan
DE	Bettpfanne
ES	Calentador de cama
FR	Bassin
IT	Padella



Bedpan Hand Made
FM- 29-7038-01
Standard



Bedpan Hand Made
FM- 29-7039-01 Adult
FM- 29-7039-02 Child



Bedpan Hand Made
FM- 29-7040-01
Standard



Bedpan Simple
pressed body with handle
FM- 29-7042-01 Adult
FM- 29-7042-02 Child



Bedpan Sleeper Type
FM- 29-7043-01 Adult
FM- 29-7043-02 Child



Bedpan Chamber Port
FM- 29-7044-01
Standard

Urinal, Bedpan, Bucket, Jug EN

Pissoir, Bedpan, Eimer, Krug DE

Urinario, Bedpan, Cubo, Jarro ES

Urinoir, bassin de lit, seau, cruche FR

Orinatoio, Padella, Secchio, Brocca IT

29



FAIZAN & MUSA
SPECIAL PATENTED

HOLLOWWARE



Urinal Female
FM- 29-7045-01
Standard

Urinal Male Vertical
FM- 29-7046-01
Standard

Urinal Male
FM- 29-7047-01
Standard



**Bedpan perfection
type seamless**
FM- 29-7048-01
350x300mm



Bedpan perfection type
FM- 29-7049-01 370x290mm
FM- 29-7049-02 320x240mm



Measuring Jug
FM- 29-7050-01 0.5 Ltr
FM- 29-7050-02 1.0 Ltr
FM- 29-7050-03 1.5 Ltr
FM- 29-7050-04 2.0 Ltr



Pail/Bucket with Lid
FM- 29-7051-01 06 Ltr
FM- 29-7052-02 10 Ltr
FM- 29-7052-03 15 Ltr



Douch Can/Irrigator
FM- 29-7052-01 1.0 Ltr
FM- 29-7052-02 1.5 Ltr
FM- 29-7052-03 2.0 Ltr



Address:
Aulakh Jattan P.O. Ugoki Sialkot PAKISTAN

Cell#:
+92 325 4324206

Email:
info@fm-surgical.com

Web:
www.fm-surgical.com

